

Art.Nr.: 359658, 542592, 551441

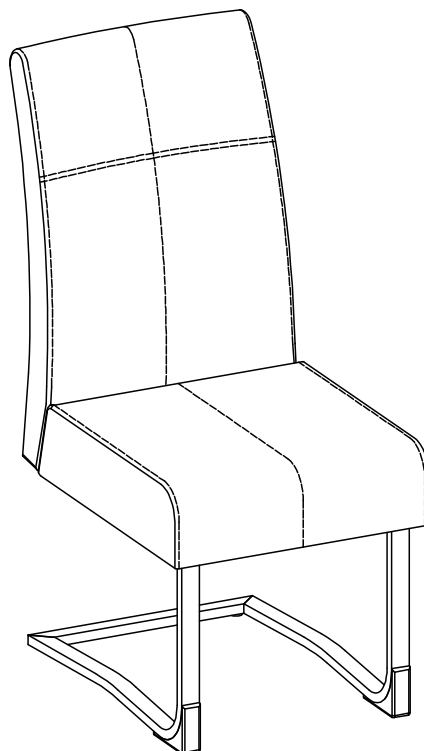

- | | | | |
|-----------|------------------------------------|-----------|--------------------------------|
| D | Montageanleitung | GB | Assembly instructions |
| FR | Notice de montage | IT | Istruzioni di montaggio |
| NL | Handleiding voor de montage | PL | Instrukcja montażu |
| CZ | Montážní návod | SK | Návod na montáž |
| HU | Szerelési útmutató | RO | Instrucțiuni de montaj |
| TR | Montaj talimatı | RU | Инструкция по монтажу |

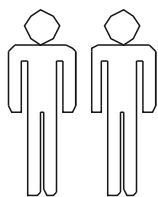

LKZ040779

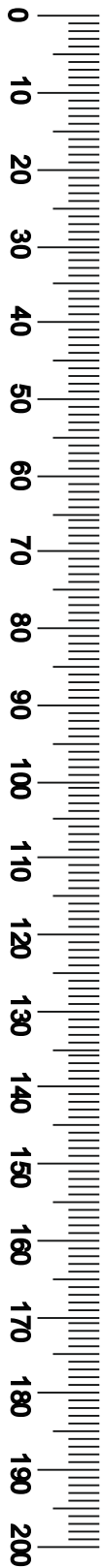

Service . Assistenza . Dienstverlening . Serwis Servis . Szerviz

Name.Nom.Nome.Neam.
Nazwa.Jmeno.Nazov.Nev
Denumire.Iem

RAB

Nr. No. N. Homep.Č. Sz
359658, 542592, 551441

Typ . Type . Tip . Tipus . Tipo

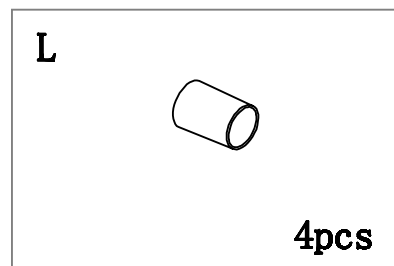
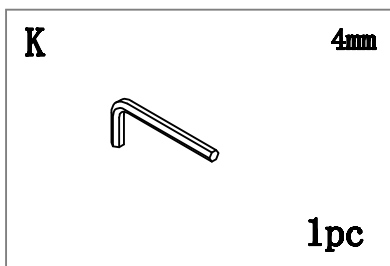
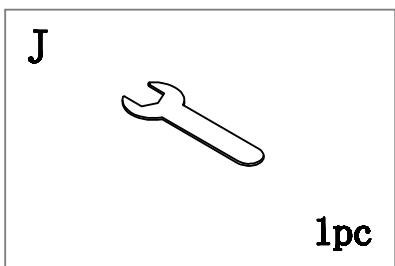
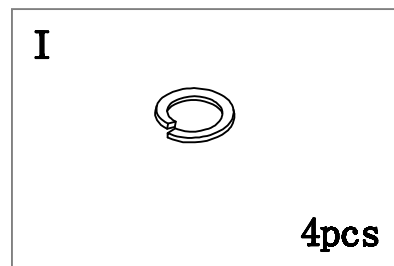
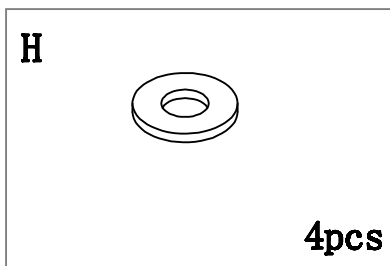
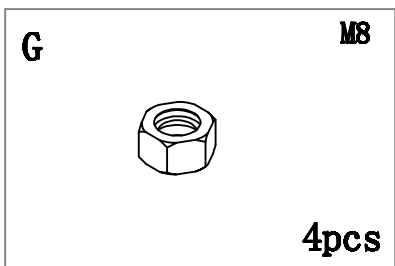
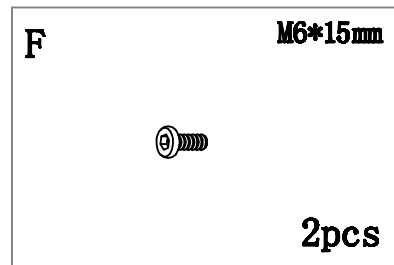
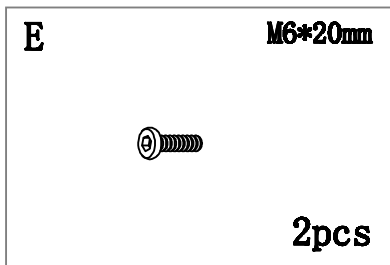
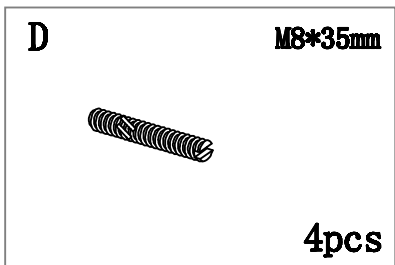
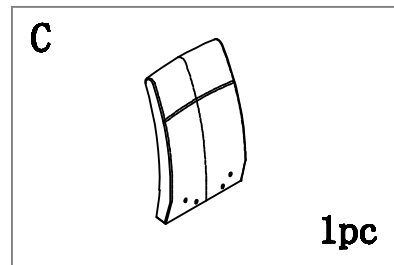
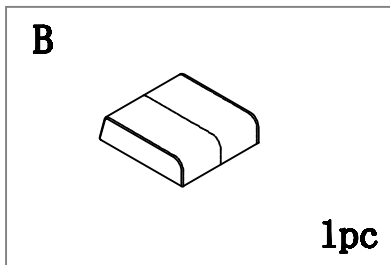
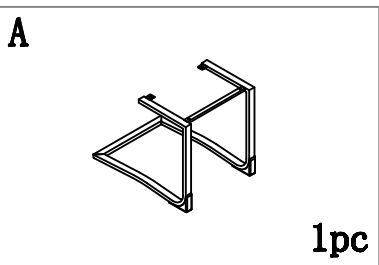
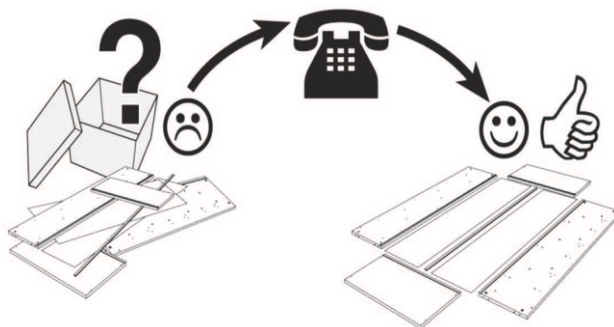
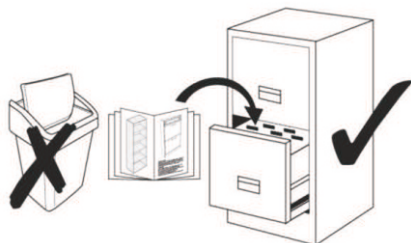

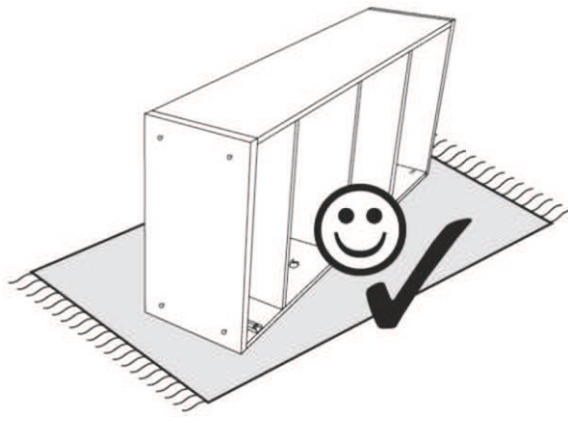

1 100%

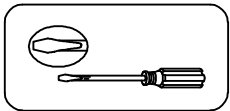
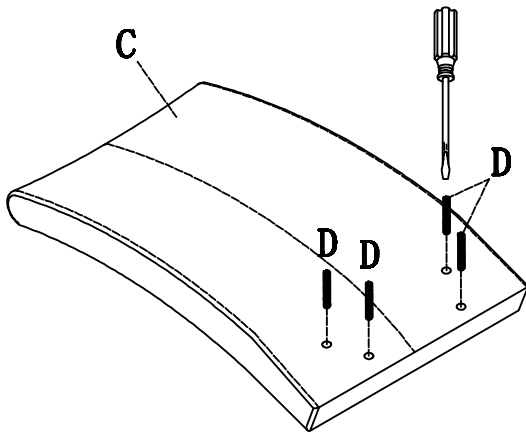

2 100%

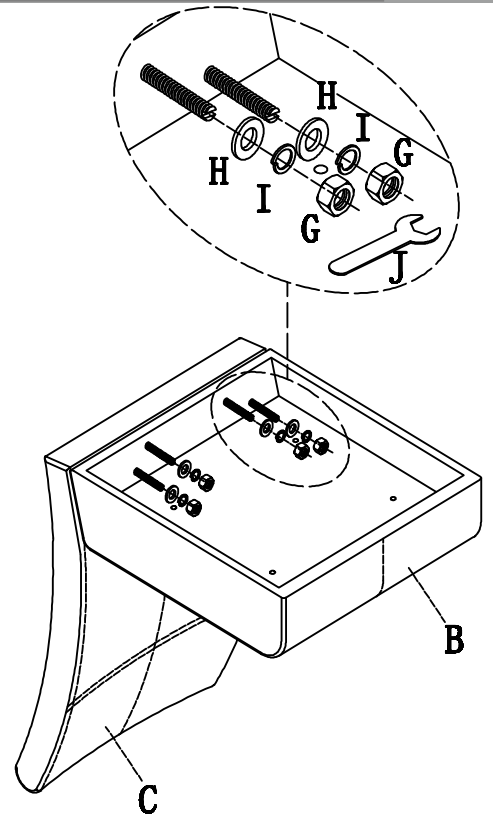

3

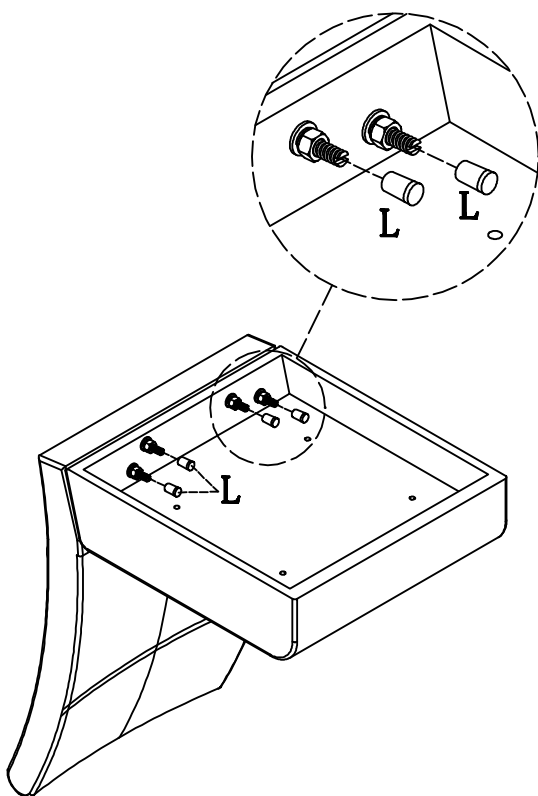

4 100%

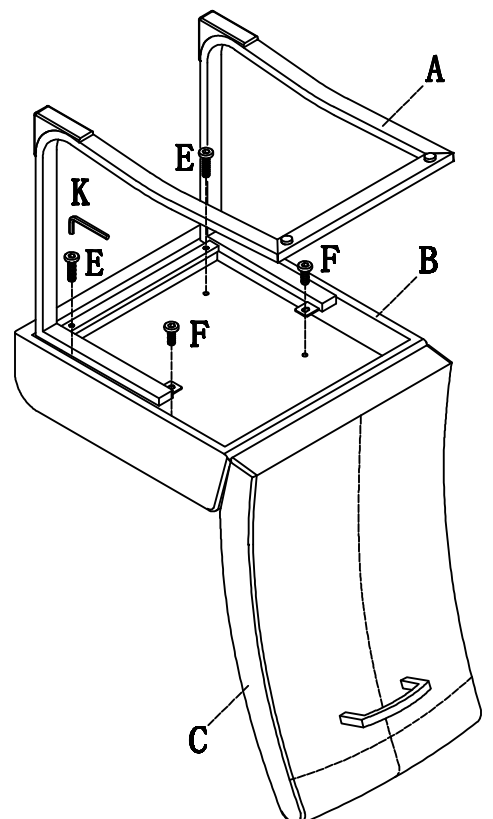

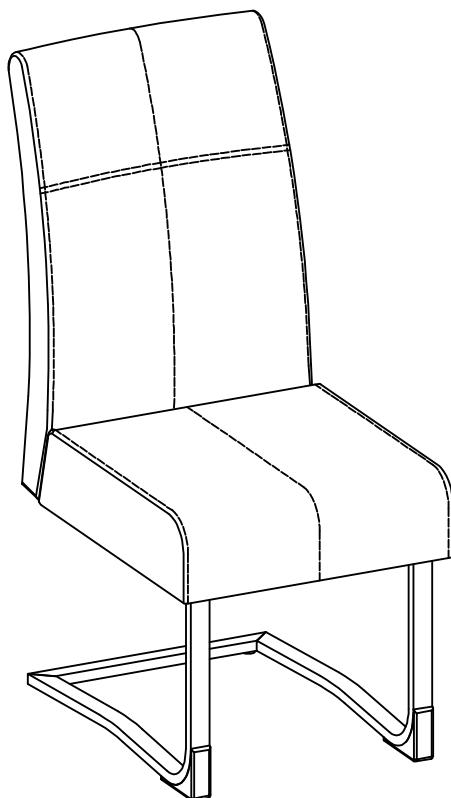

- D Allgemeiner Sicherheitshinweis:**
Nicht mehr benötigte Verpackungs-Materialien und Kleinteile von Kindern fernhalten!
- GB General safety instructions:**
Package material you do not need any more take far away from children.
- F Consigne de sécurité:**
Ecarter les matériaux d'emballage et petites pièces inutiles de la portée des enfants.
- PL Ogólne zasady bezpieczeñstwa:**
Nie potrzebne opakowania i małe części chronić przed dziećmi!
- RU Общие указания по безопасности:**
Неиспользуемые упаковочные материалы и мелкие детали следует хранить в недоступном для детей месте!
- NL Algemene veiligheidsinstructie:**
Verpakkingsmaterialen die u niet meer nodig heeft en kleine onderdelen uit de buurt van kinderen houden!
- TR Genel güvenlik uyarısı:**
Kullanılmayan ambalaj malzemeleri ve küçük parçaları çocuklardan uzak tutun!
- RO Indicație generală de siguranță:**
Ambalajele care nu mai sunt necesare și piesele de mici dimensiuni nu vor fi lăsate la îndemâna copiilor!
- IT Indicazioni generali per la sicurezza:**
Tenere lontano da bambini materiali di imballaggio non più necessari e minuterie!
- SK Všeobecné bezpečnostné upozornenie:**
Nepotrebný baliaci materiál a malé diely uchovávajte mimo dosahu detí!
- CZ Všeobecné bezpečnostní upozornění:**
Obalové materiály a malé díly, které už nepotřebujete, udržujte mimo dosah dětí!
- HU Általános biztonsági tudnivaló:**
Ha már nincs szüksége a csomagolóanyagokra és apró darabokra, tegye őket olyan helyre, ahol nem férhetnek hozzá gyermekek!