

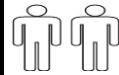

D - Montageanleitung GB - Assembly instructions NL - Handleiding voor de montage
 PL - Instrukcja montazu TR - Montaj talimatu RU - Инструкция по монтажу
 RO - Instrucțiuni de montaj IT - Istruzioni di montaggio FR - Notice de montage
 SK - Navod na monta CZ - Montážní návod HU - Szerelési utmutató HR - Upute za montažu
 SI - Navodila za montažo BG - Инструкция за сглобяване



1/2

Name-Naam-Nazwa-Isim-Название-Nume-Nome-Nom-Názov-Název-Nev-Ime-Име

MEDAN OTMBK.2F.REC

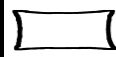

BX3

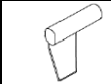

CX3

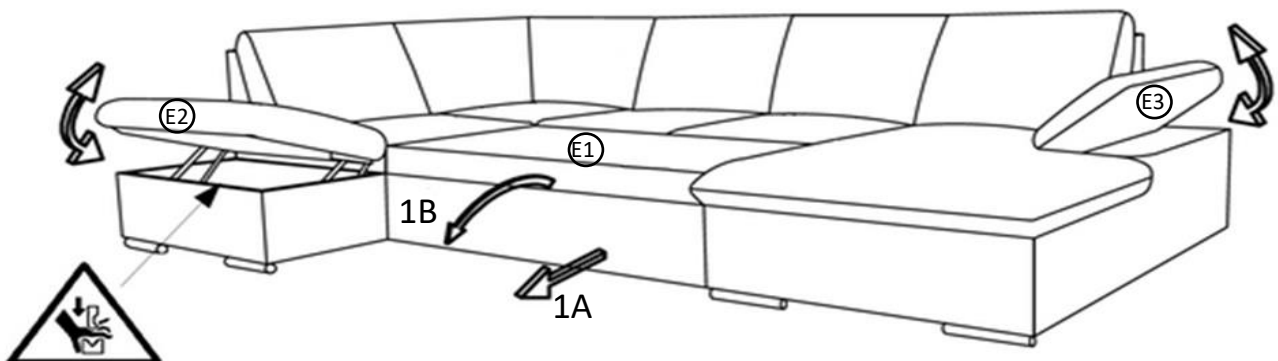
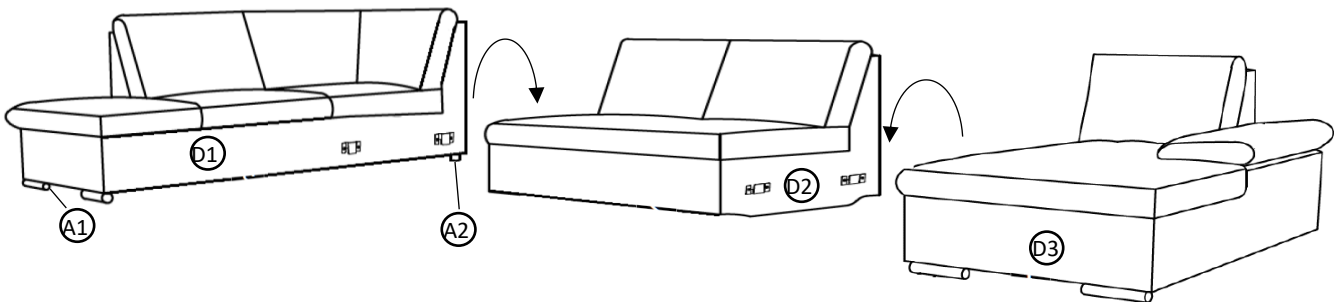
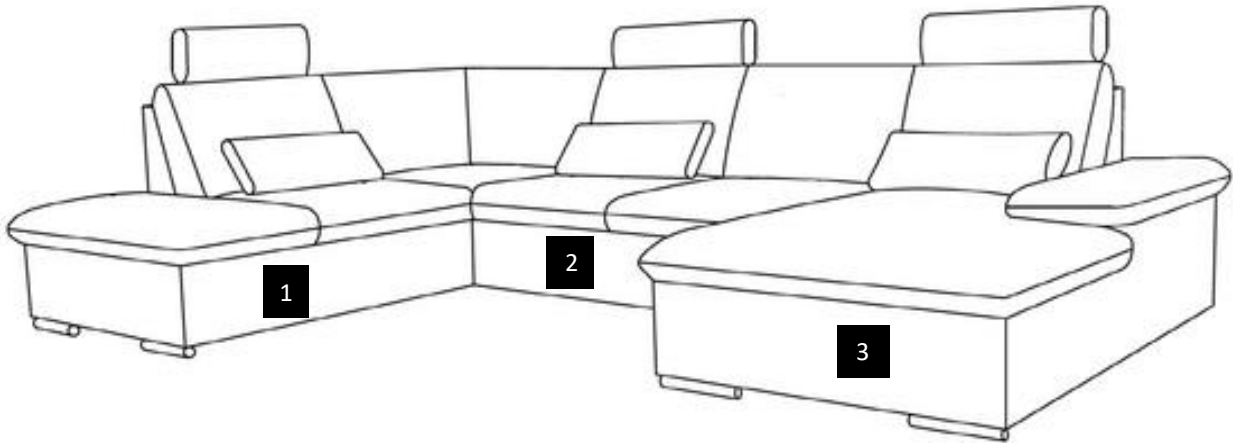
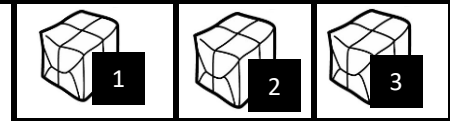



D - Montageanleitung GB - Assembly instructions NL - Handleiding voor de montage
 PL - Instrukcja montazu TR - Montaj talimatu RU - Инструкция по монтажу
 RO - Instructiuni de montaj IT - Istruzioni di montaggio FR - Notice de montage
 SK - Navod na monta CZ - Monta ni navod HU - Szerelési utmutató HR - Upute za montažu
 SI - Navodila za montažo BG - Инструкция за сглобяване

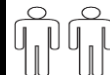

2/2

Name-Naam-Nazwa-Isim-Название-Nume-Nome-Nom-Názov-Název-Nev-Ime-Име

MEDAN OTMBK.2F.REC

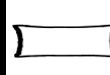

BX3

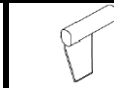

CX3

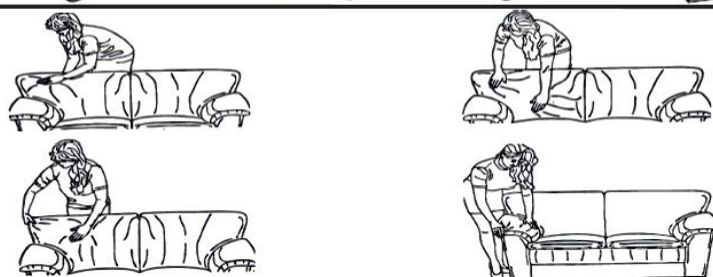
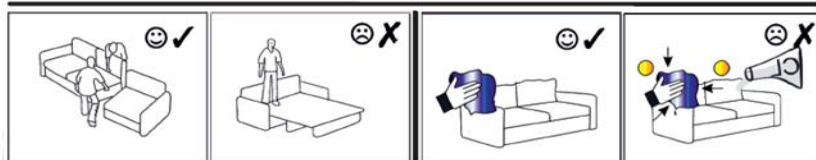
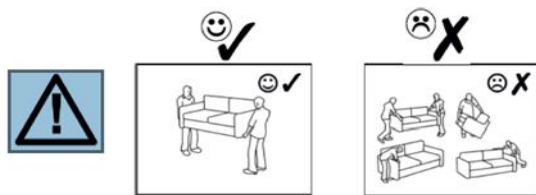
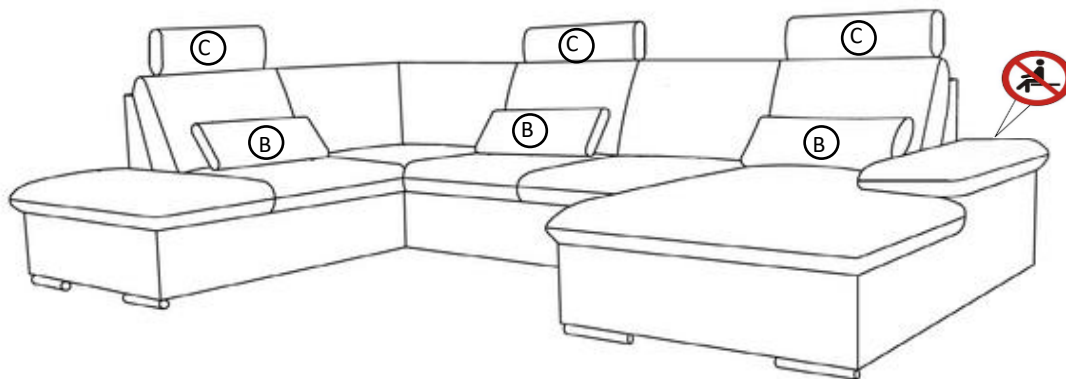
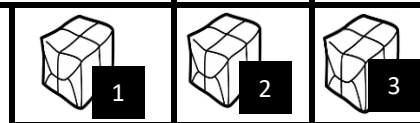

DE

Liebe Kundin, lieber Kunde,

Ihr neues Sofa ist nach dem anstrengenden Transport ein wenig „gestresst“ und das sieht man ihm auch an.

Deshalb:

- Streichen, Klopfen und Schütteln Sie alle Polster ein wenig zurecht, so wie es die Zeichnungen zeigen.
- Das verleiht dem Sofa Aussehen, Eleganz und Attraktivität.

Viel Freude an Ihrem neuen Sofa wünscht Ihnen

Ihre Produktentwicklung

GB

Dear customer,

Your new sofa is somewhat "stressed" from the strenuous transport as can be seen.

For this reason:

- Smooth, knock, and shake all upholstery somewhat to achieve the appearance shown in the illustrations.
- This leaves your sofa looking prim, elegant, and inviting.

We wish you plenty of enjoyment with your new sofa

Your product development team

Service-Dienstverlening-Serwis-Servis-Сервисная служба-Serviciu-Servizio-Služby-Szerviz-Storitev-Обслужване

Typ-Type-Tip-Tip-Tastati-Tipo-Tipus

A1		E1			
A2		E2			
B		E3			
C					
D1					
D2					
D3					



Serien-/Chargen-Nr.-