

- | | |
|---|-------------------------------------|
| (D) Montageanleitung | (GB) Assembly instructions |
| (FR) Notice de montage | (IT) Istruzioni di montaggio |
| (NL) Handleiding voor de montage | (PL) Instrukcja montażu |
| (CZ) Montážní návod | (SK) Návod na montáž |
| (HU) Szerelési útmutató | (RO) Instrucțiuni de montaj |
| (TR) Montaj talimatı | (RU) Инструкция по монтажу |

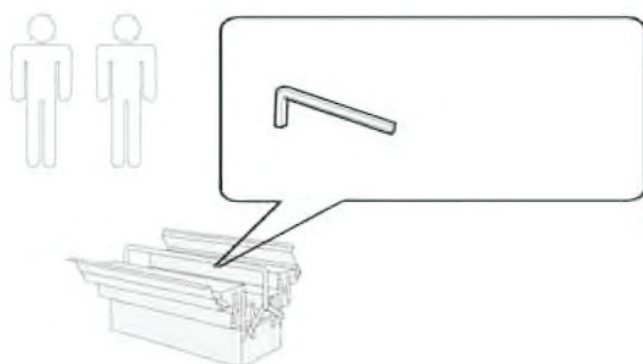

**Service • Assistenza • Dienstverlening • Serwis
Servis • Szerviz • Сервисная служба**

Name • Nom • Nome • Naam Nazwa • Jméno • Назов • Név Denimire • Isim • Название	
Nr. • No. • N° • Номер • С. • Sz	6337 2423 8367 6029
Typ • Type • Тип • Tipus • Tipo Тип	

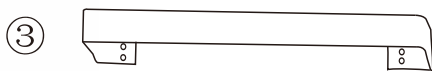
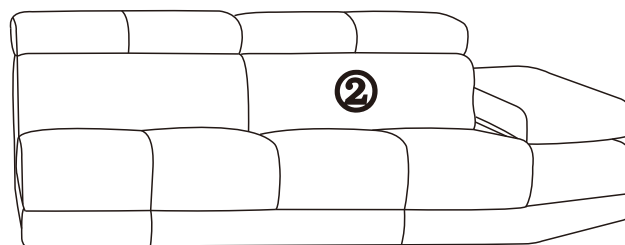
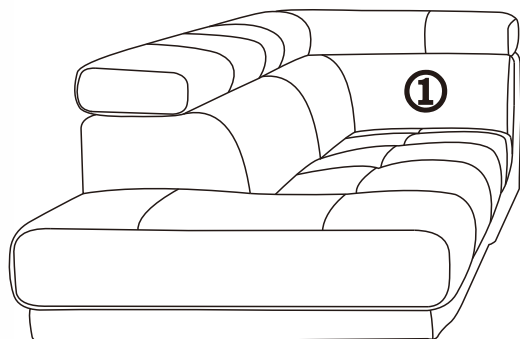

X4

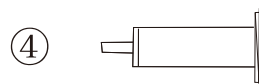

X1

A	M8	B	M8X30	C	3.5A	D	M3.5	E	M5.5
X16		X16		X1		X8		X1	

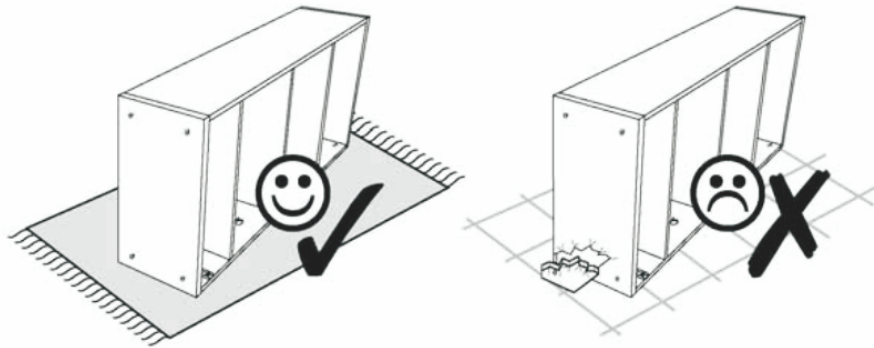



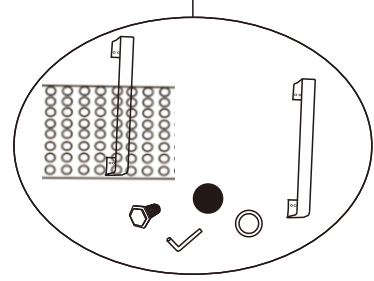
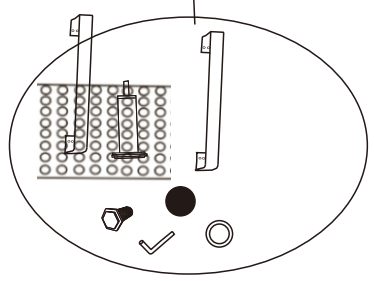
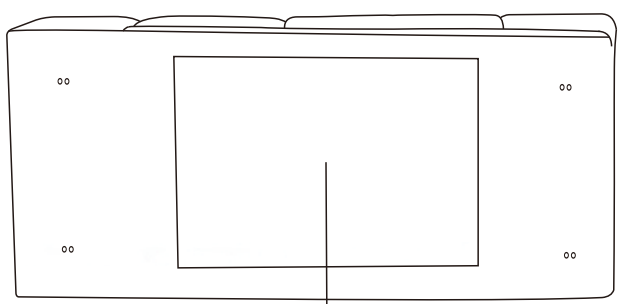
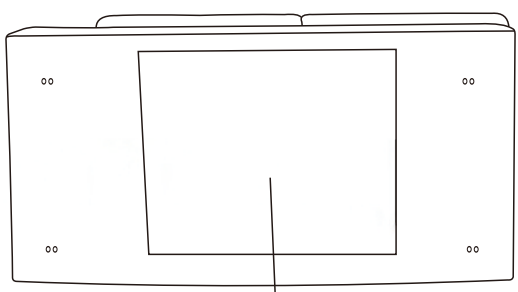

1

①

②



2

A	M8	B	M8X30	C	3.5A	D	M3.5	E	M5.5
									
X16		X16		X1		X8		X1	

①

②

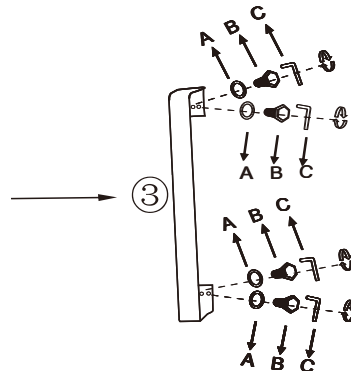
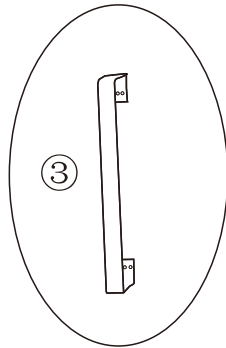
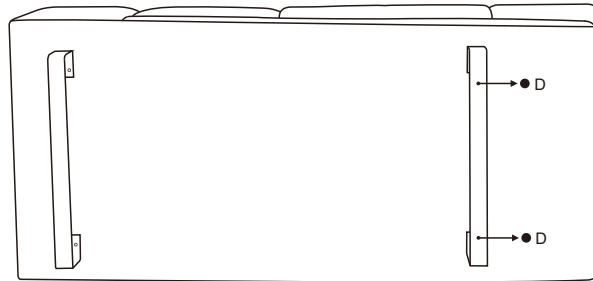
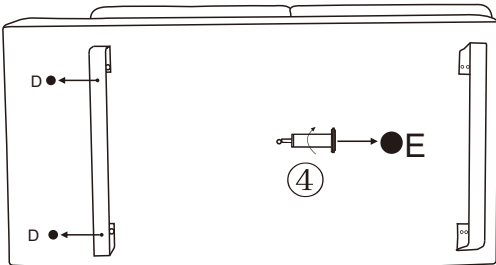

3

