

5

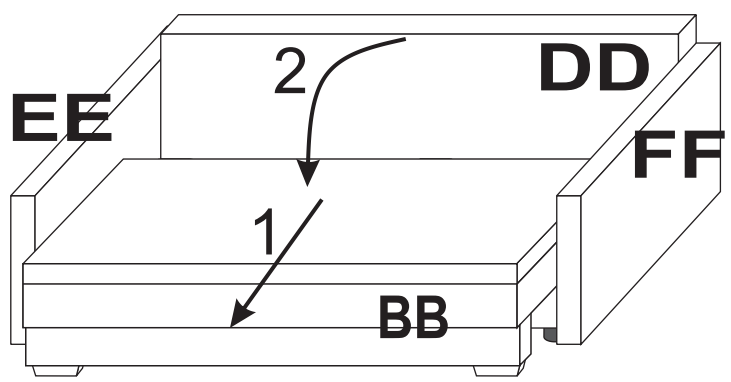

6

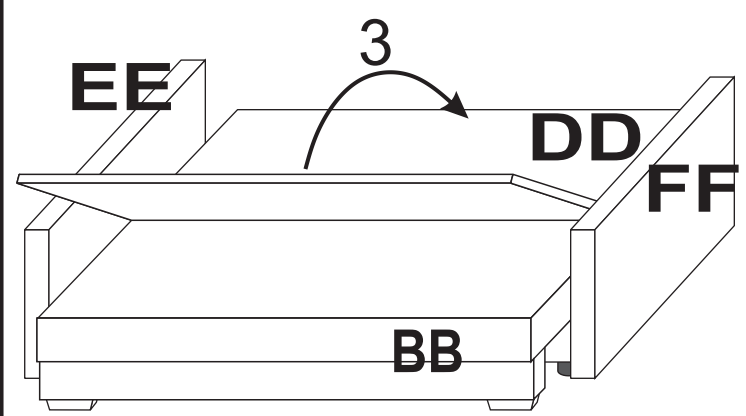

7

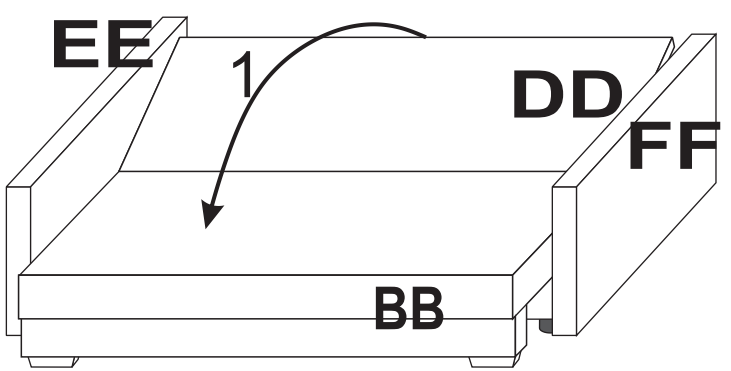

8

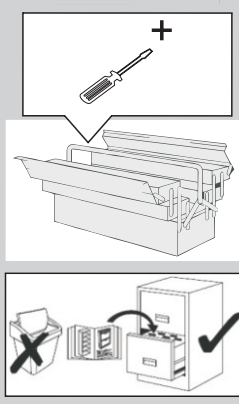
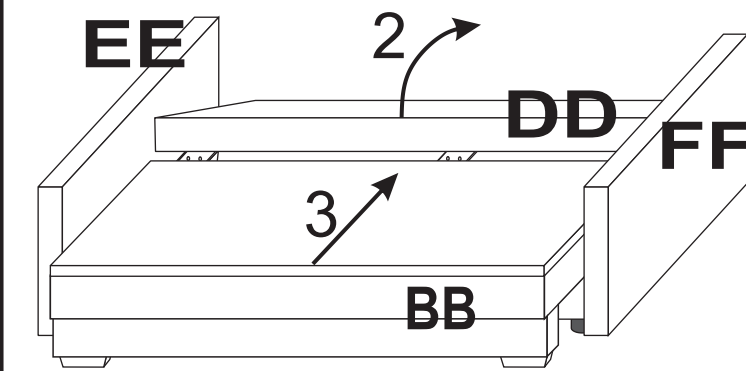

ANDREA



- (DE) Montageanleitung
- (IT) Istruzioni di montaggio
- (PL) Instrukcja montażu
- (FR) Notice de montage
- (NL) Handleiding voor de montage
- (RO) Instrucțiuni de asamblare
- (GB) Assembly instructions
- (SK) Montážny návod
- (TR) Montaj talimatı
- (CZ) Montážní návod
- (RU) Инструкция по монтажу
- (HU) Szerelési útmutató



Name - Nazwa - Naam - Name - Isim - название
 Nome - Nom - Numele - Meno - Jméno - Neve

ANDREA

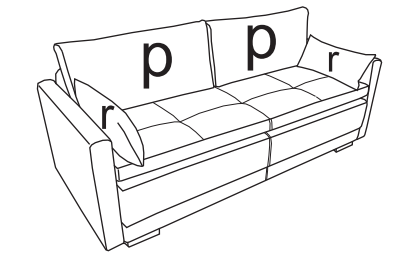

9x (4x16)	6x (5x35)	4x (M6x40)	4x (M6x35)	10x	4x Ø8	4x Ø8
a	b	c	d	e	f	g
4x M8	6x 35mm	2x 50mm	2x 155mm	4x (M8x70)	2x	2x
i	j	k	m	n	p	r



Service - Servis - Dienstverlening - Servis - Serwis - Сервисная служба - Servizio - Service
 Serviciu - Služby - Szolgáltatás

COLLI 1

COLLI 2

COLLI 3

2x p

2x r

Ver: 19.03.2024

