

1.

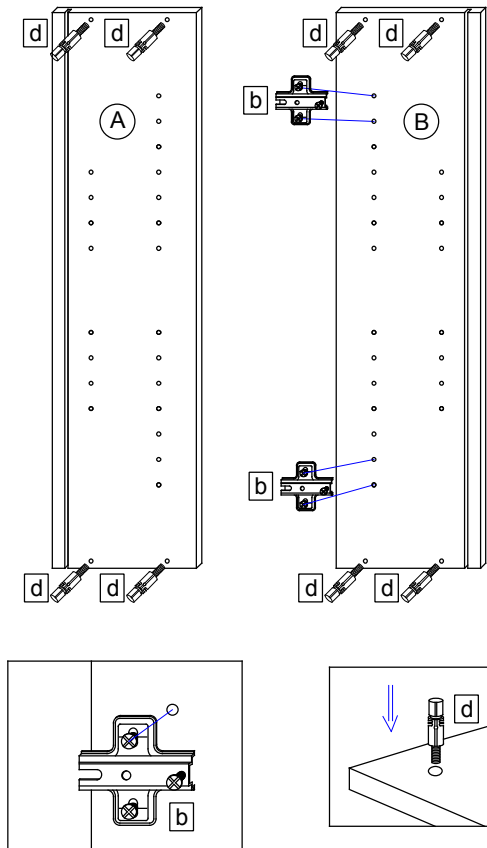

2.

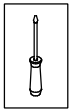
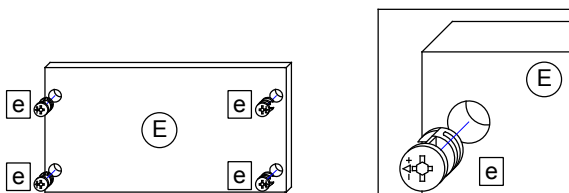
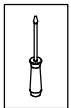

3.

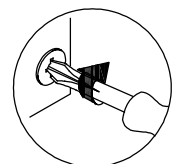
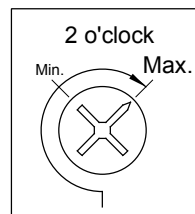
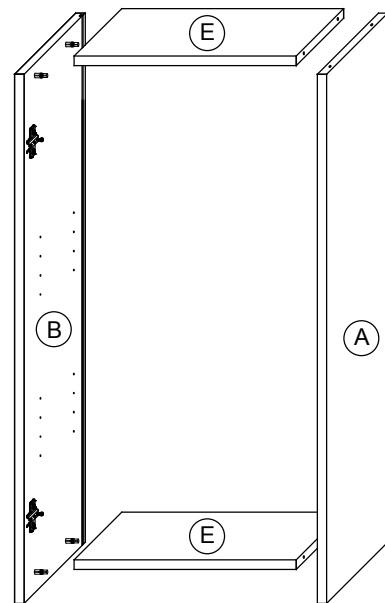
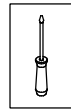

4.

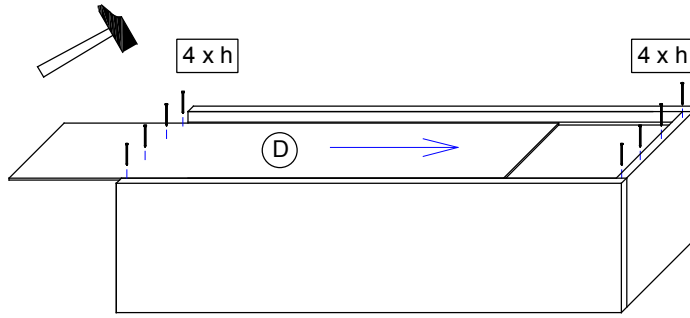
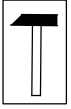

5.

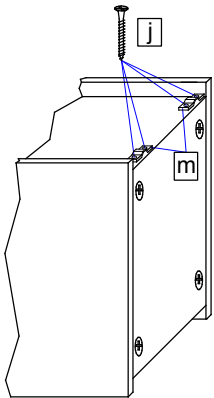
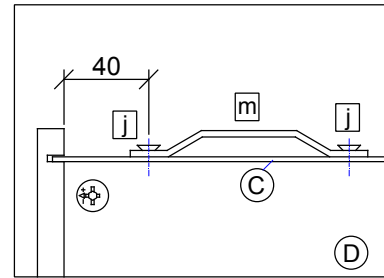
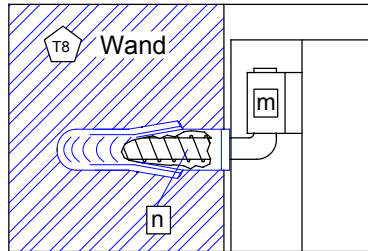
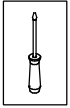

T9 Lassen Sie den Schrank nur durch fachkundige Personen mit für die Wand geeignetem Montagematerialien montieren.

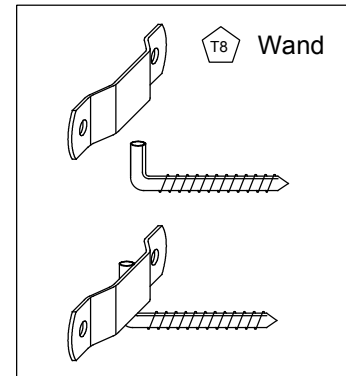

6.

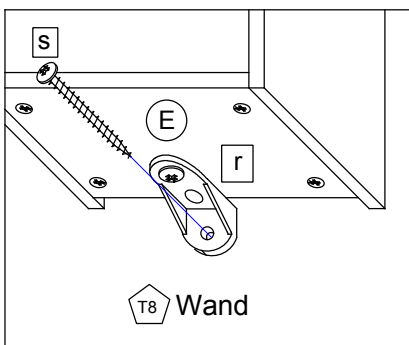
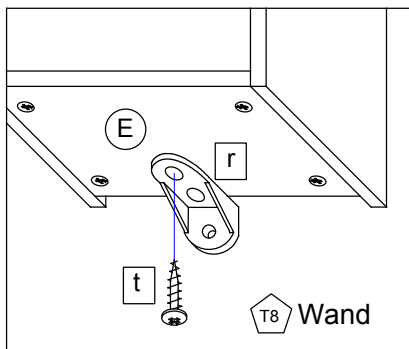
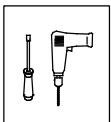

7.

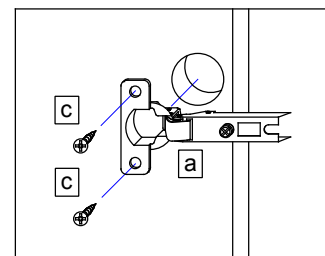
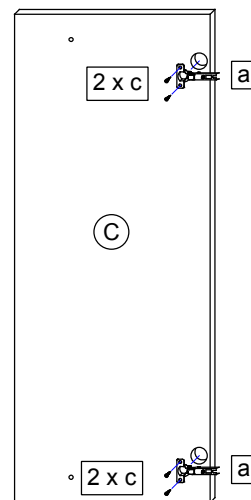
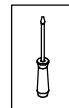

8.

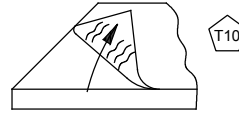
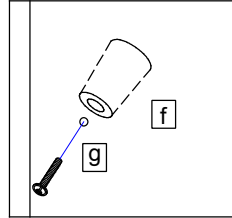
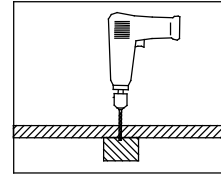
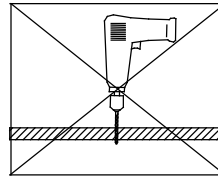
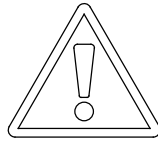
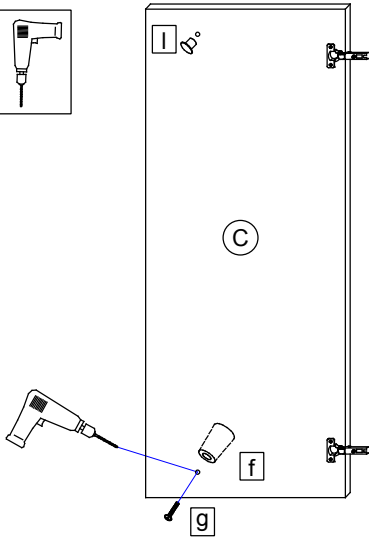

Bei Hochglanz-Fronten bitte erst die Schutzfolie entfernen und dann den Griff montieren!

9.

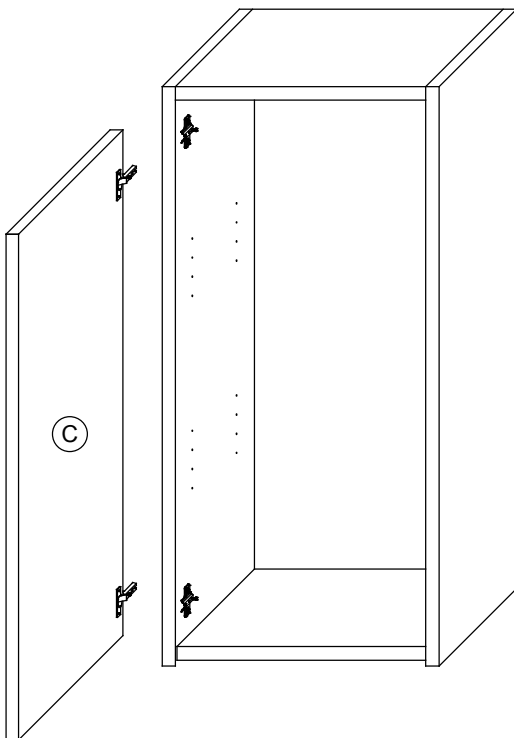
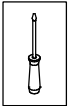

T11 Bei Türmontage das Scharnier einhängen, bis Anschlag öffnen und anschließend festschrauben.

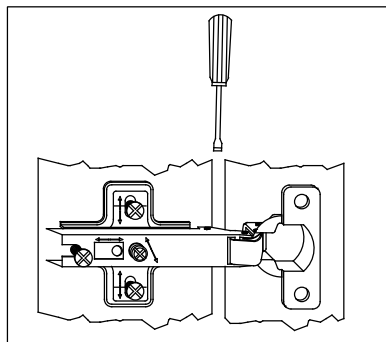
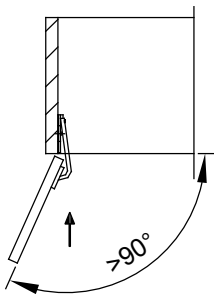

10.

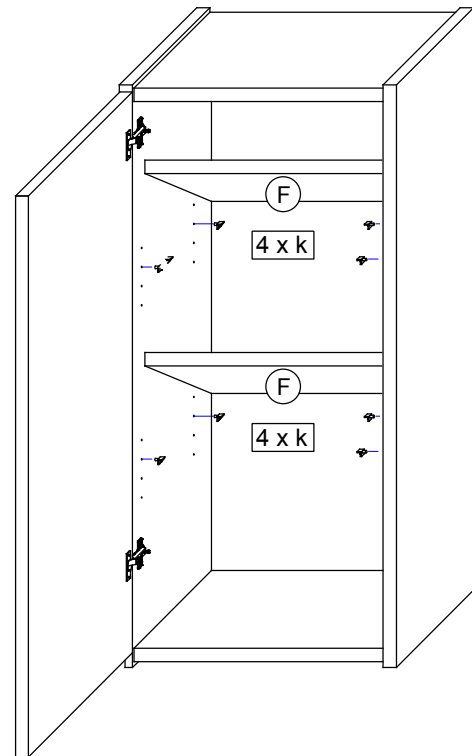

T12 Das Möbel bitte nur mit einem feuchten Tuch reinigen.