

 **cybex**  
GOLD

**EOS LUX**

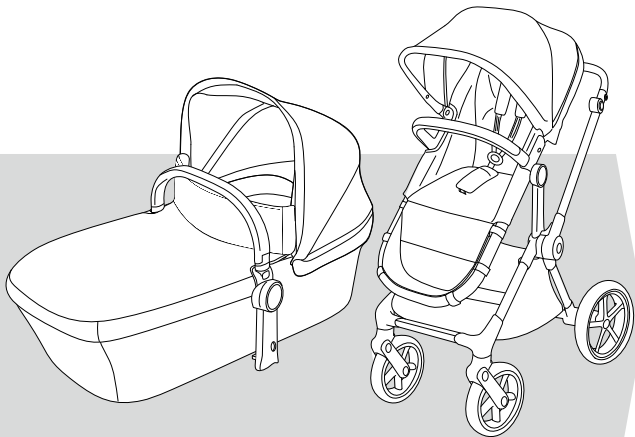



**EN** WARNING  
**DE** WARNUNG  
**ES** ADVERTENCIA  
**FR** AVERTISSEMENT  
**PT** AVISOS  
**IT** ATTENZIONE  
**NL** WAARSCHUWING  
**PL** OSTRZEŻENIE  
**CS** UPOZORNĚNÍ  
**SK** UPOZORNENIE  
**SL** OPOZORILO  
**HR** UPOZORENJE  
**HU** FIGYELMEZTETÉS  
**SE** VARNING  
**NO** ADVARSEL  
**FI** VAROITUS  
**DA** ADVARSEL  
**ET** HOIATUS  
**LV** BRĪDINĀJUMS  
**LT** PERSPĖJIMAS  
**RU** ВНИМАНИЕ  
**UK** УВАГА  
**TR** UYARI  
**EL** ΠΡΟΕΙΔΟΠΟΙΗΣΗ  
**RO** AVERTISMENTE  
**IS** VIÐVÖRUN  
**MT** TWISSIJA



**AR**  
**FA**  
**YUE** 警告  
**CMN** 警告  
**JA** 警告  
**KO** 경고  
**BG** ПРЕДУПРЕЖДЕНИЕ  
**SR** UPOZORENJE  
**MS** AMARAN  
**HI** चेतावनी  
**TH** คำเตือน  
**SQ** PARALAJMËRIM  
**BS** UPOZORENJE  
**ME** UPOZORENJE  
**MK** ПРЕДУПРЕДУВАЊЕ  
**HY** ՉԳՈՒԸԱՅՈՒՄ  
**VI** CẢNH BÁO

تحذير  
اخطار



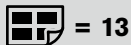

= 13

|           |                     |            |                         |
|-----------|---------------------|------------|-------------------------|
| <b>EN</b> | Maximum weights     | <b>TR</b>  | Maksimum ağırlıklar     |
| <b>DE</b> | Maximalgewichte     | <b>EL</b>  | Μέγιστο βάρος           |
| <b>ES</b> | Pesos máximos       | <b>RO</b>  | Greutăți maxime         |
| <b>FR</b> | Poids maximum       | <b>IS</b>  | Hámarksþyngd            |
| <b>PT</b> | Pesos máximos       | <b>MT</b>  | Piżijiet massimi        |
| <b>IT</b> | Peso massimo        | <b>AR</b>  | الأوزان القصوى          |
| <b>NL</b> | Maximengewicht      | <b>FA</b>  | حداکثر وزن              |
| <b>PL</b> | Dopuszczalna waga   | <b>YUE</b> | 最大重量                    |
| <b>CS</b> | Maximální hmotnosti | <b>CMN</b> | 最大重量                    |
| <b>SK</b> | Maximálne hmotnosti | <b>JA</b>  | 最大重量                    |
| <b>SL</b> | Največje teže       | <b>KO</b>  | 최대 하중                   |
| <b>HR</b> | Maksimalne težine   | <b>BG</b>  | Максимални тегла        |
| <b>HU</b> | Maximális súlyok    | <b>SR</b>  | Maksimalne težine       |
| <b>SE</b> | Max.vikter          | <b>MS</b>  | Berat maksimum          |
| <b>NO</b> | Maksimumsvektor     | <b>HI</b>  | अधिकतम बजन              |
| <b>FI</b> | Enimmäispainot      | <b>TH</b>  | น้ำหนักสูงสุด           |
| <b>DA</b> | Maksimumvægt        | <b>SQ</b>  | Peshat maksimale        |
| <b>ET</b> | Maksimaalne kaal    | <b>BS</b>  | Maksimalne težine       |
| <b>LV</b> | Maksimālais svars   | <b>ME</b>  | Maksimalne težine       |
| <b>LT</b> | Didžiausi svoriai   | <b>MK</b>  | Максимални тежини       |
| <b>RU</b> | Максимальная масса  | <b>HY</b>  | Առավելագույն քաշեր      |
| <b>UK</b> | Максимальна вага    | <b>VI</b>  | Các mức cân nặng tối đa |

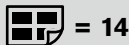

= 14

|           |                            |            |                            |
|-----------|----------------------------|------------|----------------------------|
| <b>EN</b> | Product registration       | <b>TR</b>  | Ürün kaydı                 |
| <b>DE</b> | Produktregistrierung       | <b>EL</b>  | Καταχώριση προϊόντος       |
| <b>ES</b> | Registro del producto      | <b>RO</b>  | Înregistrarea produsului   |
| <b>FR</b> | Enregistrement du produit  | <b>IS</b>  | Skráning tækis             |
| <b>PT</b> | Registo do produto         | <b>MT</b>  | Reġistrazzjoni tal-prodott |
| <b>IT</b> | Registrazione del prodotto | <b>AR</b>  | تسجيل المنتج               |
| <b>NL</b> | Productregistratie         | <b>FA</b>  | ثبت محصول                  |
| <b>PL</b> | Rejestracja produktu       | <b>YUE</b> | 產品註冊                       |
| <b>CS</b> | Registrace výrobku         | <b>CMN</b> | 产品注册                       |
| <b>SK</b> | Registrácia výrobku        | <b>JA</b>  | 製品の登録                      |
| <b>SL</b> | Registracija izdelka       | <b>KO</b>  | 제품 등록                      |
| <b>HR</b> | Registracija proizvoda     | <b>BG</b>  | Регистрация на продукта    |
| <b>HU</b> | Termékregisztráció         | <b>SR</b>  | Registracija proizvoda     |
| <b>SE</b> | Produktregistrering        | <b>MS</b>  | Pendaftaran produk         |
| <b>NO</b> | Produktregistrering        | <b>HI</b>  | उत्पाद पंजीकरण             |
| <b>FI</b> | Tuotteen rekisteröinti     | <b>TH</b>  | การลงทะเบียนผลิตภัณฑ์      |
| <b>DA</b> | Produktregistrering        | <b>SQ</b>  | Regjistrimi i produktit    |
| <b>ET</b> | Toote registreerimine      | <b>BS</b>  | Registracija proizvoda     |
| <b>LV</b> | Produkta registrācija      | <b>ME</b>  | Registracija proizvoda     |
| <b>LT</b> | Gaminio registracija       | <b>MK</b>  | Регистрација на производ   |
| <b>RU</b> | Регистрация продукта       | <b>HY</b>  | Ապրանքի գրանցում           |
| <b>UK</b> | Реєстрація продукту        | <b>VI</b>  | Đăng ký sản phẩm           |



 = 18

|           |                |            |                 |
|-----------|----------------|------------|-----------------|
| <b>EN</b> | Set up         | <b>EL</b>  | Στήσιμο         |
| <b>DE</b> | Aufbau         | <b>RO</b>  | Setare          |
| <b>ES</b> | Instalación    | <b>IS</b>  | Uppsetning      |
| <b>FR</b> | Montage        | <b>MT</b>  | Konfigurazzjoni |
| <b>PT</b> | Preparação     | <b>AR</b>  | تنصيب           |
| <b>IT</b> | Configurazione | <b>FA</b>  | بريا کردن       |
| <b>NL</b> | Opbouw         | <b>YUE</b> | 設置              |
| <b>PL</b> | Montaż         | <b>CMN</b> | 设置              |
| <b>CS</b> | Nastavení      | <b>JA</b>  | セットアップ          |
| <b>SK</b> | Nastavenie     | <b>KO</b>  | 설정              |
| <b>SL</b> | Nastavitev     | <b>BG</b>  | Настройка       |
| <b>HR</b> | Postavljanje   | <b>SR</b>  | Postavljanje    |
| <b>HU</b> | Felszerelés    | <b>MS</b>  | Persediaan      |
| <b>SE</b> | Inställning    | <b>HI</b>  | सेट अप          |
| <b>NO</b> | Oppsett        | <b>TH</b>  | การติดตั้ง      |
| <b>FI</b> | Asennus        | <b>SQ</b>  | Konfigurimi     |
| <b>DA</b> | Opsætning      | <b>BS</b>  | Postavljanje    |
| <b>ET</b> | Seadistamine   | <b>ME</b>  | Postavljanje    |
| <b>LV</b> | Uzstādīšana    | <b>MK</b>  | Поставување     |
| <b>LT</b> | Nuostatos      | <b>HY</b>  | Շարժափոխում     |
| <b>RU</b> | Установка      | <b>VI</b>  | Cài đặt         |
| <b>UK</b> | Встановлення   | <b>TR</b>  | Kurulum         |



 = 34

|           |          |            |             |
|-----------|----------|------------|-------------|
| <b>EN</b> | Brake    | <b>EL</b>  | Φρένα       |
| <b>DE</b> | Bremse   | <b>RO</b>  | Frână       |
| <b>ES</b> | Freno    | <b>IS</b>  | Bremsa      |
| <b>FR</b> | Frein    | <b>MT</b>  | Brejġ       |
| <b>PT</b> | Bloqueio | <b>AR</b>  | المكابح     |
| <b>IT</b> | Freno    | <b>FA</b>  | ترمز        |
| <b>NL</b> | Rem      | <b>YUE</b> | 剎車          |
| <b>PL</b> | Hamulec  | <b>CMN</b> | 刹车          |
| <b>CS</b> | Brzda    | <b>JA</b>  | ブレーキ        |
| <b>SK</b> | Brzda    | <b>KO</b>  | 브레이크        |
| <b>SL</b> | Zavora   | <b>BG</b>  | Спирачка    |
| <b>HR</b> | Kočnica  | <b>SR</b>  | Kočnica     |
| <b>HU</b> | Fék      | <b>MS</b>  | Brek        |
| <b>SE</b> | Broms    | <b>HI</b>  | ब्रेक       |
| <b>NO</b> | Brems    | <b>TH</b>  | เบรค        |
| <b>FI</b> | Jarru    | <b>SQ</b>  | Frenat      |
| <b>DA</b> | Bremse   | <b>BS</b>  | Kočnica     |
| <b>ET</b> | Pidur    | <b>ME</b>  | Kočnica     |
| <b>LV</b> | Bremze   | <b>MK</b>  | Сопирачка   |
| <b>LT</b> | Stabdys  | <b>HY</b>  | Սրբեխալ     |
| <b>RU</b> | Тормоза  | <b>VI</b>  | Phanh thắng |
| <b>UK</b> | Гальма   |            |             |
| <b>TR</b> | Fren     |            |             |



 = 34

|           |                    |            |              |
|-----------|--------------------|------------|--------------|
| <b>EN</b> | Folding            | <b>EL</b>  | Αναδίπλωση   |
| <b>DE</b> | Faltung            | <b>RO</b>  | Pliere       |
| <b>ES</b> | Plegado            | <b>IS</b>  | Brjóta saman |
| <b>FR</b> | Pliant             | <b>MT</b>  | Tiwi         |
| <b>PT</b> | Fecho              | <b>AR</b>  | قابلة للطى   |
| <b>IT</b> | Ripiegamento       | <b>FA</b>  | تا کردن      |
| <b>NL</b> | Vouwen             | <b>YUE</b> | 折疊           |
| <b>PL</b> | Składanie          | <b>CMN</b> | 折疊           |
| <b>CS</b> | Skládání           | <b>JA</b>  | 折りたたみ        |
| <b>SK</b> | Zloženie           | <b>KO</b>  | 접기           |
| <b>SL</b> | Zlaganje           | <b>BG</b>  | Сгъване      |
| <b>HR</b> | Preklapanje        | <b>SR</b>  | Preklapanje  |
| <b>HU</b> | Összecsukás        | <b>MS</b>  | Lipat        |
| <b>SE</b> | Ihopfällning       | <b>HI</b>  | फोल्डिंग     |
| <b>NO</b> | Sammenlegging      | <b>TH</b>  | การพับ       |
| <b>FI</b> | Kokoon taittaminen | <b>SQ</b>  | Palosja      |
| <b>DA</b> | Sammenklapning     | <b>BS</b>  | Preklapanje  |
| <b>ET</b> | Kokkuvoltimine     | <b>ME</b>  | Preklapanje  |
| <b>LV</b> | Salocīšana         | <b>MK</b>  | Склопување   |
| <b>LT</b> | Lankstymas         | <b>HY</b>  | ժալելը       |
| <b>RU</b> | Складывание        | <b>VI</b>  | Gập lại      |
| <b>UK</b> | Складання          |            |              |
| <b>TR</b> | Katlama            |            |              |



 = 38

|           |                    |            |              |
|-----------|--------------------|------------|--------------|
| <b>EN</b> | Folding            | <b>EL</b>  | Αναδίπλωση   |
| <b>DE</b> | Faltung            | <b>RO</b>  | Pliere       |
| <b>ES</b> | Plegado            | <b>IS</b>  | Brjóta saman |
| <b>FR</b> | Pliant             | <b>MT</b>  | Tiwi         |
| <b>PT</b> | Fecho              | <b>AR</b>  | قابلة للطى   |
| <b>IT</b> | Ripiegamento       | <b>FA</b>  | تا کردن      |
| <b>NL</b> | Vouwen             | <b>YUE</b> | 折疊           |
| <b>PL</b> | Składanie          | <b>CMN</b> | 折疊           |
| <b>CS</b> | Skládání           | <b>JA</b>  | 折りたたみ        |
| <b>SK</b> | Zloženie           | <b>KO</b>  | 접기           |
| <b>SL</b> | Zlaganje           | <b>BG</b>  | Сгъване      |
| <b>HR</b> | Preklapanje        | <b>SR</b>  | Preklapanje  |
| <b>HU</b> | Összecsukás        | <b>MS</b>  | Lipat        |
| <b>SE</b> | Ihopfällning       | <b>HI</b>  | फोल्डिंग     |
| <b>NO</b> | Sammenlegging      | <b>TH</b>  | การพับ       |
| <b>FI</b> | Kokoon taittaminen | <b>SQ</b>  | Palosja      |
| <b>DA</b> | Sammenklapning     | <b>BS</b>  | Preklapanje  |
| <b>ET</b> | Kokkuvoltimine     | <b>ME</b>  | Preklapanje  |
| <b>LV</b> | Salocīšana         | <b>MK</b>  | Склопување   |
| <b>LT</b> | Lankstymas         | <b>HY</b>  | ժալելը       |
| <b>RU</b> | Складывание        | <b>VI</b>  | Gập lại      |
| <b>UK</b> | Складання          |            |              |
| <b>TR</b> | Katlama            |            |              |



 = 44

|           |                    |            |                   |
|-----------|--------------------|------------|-------------------|
| <b>EN</b> | Harness            | <b>EL</b>  | Συγκράτηση        |
| <b>DE</b> | Gurtsystem         | <b>RO</b>  | Centură           |
| <b>ES</b> | Arnés              | <b>IS</b>  | Beisli            |
| <b>FR</b> | Harnais            | <b>MT</b>  | Ċinga tas-sigurtà |
| <b>PT</b> | Arnês              | <b>AR</b>  | طقم الشد          |
| <b>IT</b> | Imbracatura        | <b>FA</b>  | سیستم مهار        |
| <b>NL</b> | Harnas             | <b>YUE</b> | 安全帶               |
| <b>PL</b> | Szelki             | <b>CMN</b> | 安全帶               |
| <b>CS</b> | Popruh             | <b>JA</b>  | 安全ベルト             |
| <b>SK</b> | Popruh             | <b>KO</b>  | 하네스               |
| <b>SL</b> | Varnostni pas      | <b>BG</b>  | Сбруя             |
| <b>HR</b> | Sustav vezivanja   | <b>SR</b>  | Sistem vezivanja  |
| <b>HU</b> | Biztonsági öv      | <b>MS</b>  | Abah-abah         |
| <b>SE</b> | Sele               | <b>HI</b>  | कवच               |
| <b>NO</b> | Beltsystem         | <b>TH</b>  | ระบบสายรัด        |
| <b>FI</b> | Vyöjärjestelmä     | <b>SQ</b>  | Pajimet           |
| <b>DA</b> | Selesystem         | <b>BS</b>  | Sistem vezivanja  |
| <b>ET</b> | Turvarihmad        | <b>ME</b>  | Sistem vezivanja  |
| <b>LV</b> | Drošības josta     | <b>MK</b>  | Сигурносен каиш   |
| <b>LT</b> | Diržai             | <b>HY</b>  | Ամրապոսի          |
| <b>RU</b> | Ремни безопасности | <b>VI</b>  | Dây an toàn       |
| <b>UK</b> | Ремінь             |            |                   |
| <b>TR</b> | Emniyet kemeri     |            |                   |



 = 47

|           |                            |            |                             |
|-----------|----------------------------|------------|-----------------------------|
| <b>EN</b> | Bumper bar                 | <b>TR</b>  | Tampon çubuğu               |
| <b>DE</b> | Schutzbügel                | <b>EL</b>  | Μπάρα διάταξης<br>ροστασίας |
| <b>ES</b> | Barra de seguridad         | <b>RO</b>  | Bară de protecție           |
| <b>FR</b> | Barre de protection        | <b>IS</b>  | Þverbiti                    |
| <b>PT</b> | Barra de segurança         | <b>MT</b>  | Strixxa tal-bumper          |
| <b>IT</b> | Barra paraurti             | <b>AR</b>  | عارضة ممتص الصدمات          |
| <b>NL</b> | Veiligheidsbeugel          | <b>FA</b>  | ميله ضربه گیر               |
| <b>PL</b> | Pałak zabezpieczający      | <b>YUE</b> | 保險杠                         |
| <b>CS</b> | Dětské madlo               | <b>CMN</b> | 保險杠                         |
| <b>SK</b> | Detská rúčka               | <b>JA</b>  | バンパーバー                      |
| <b>SL</b> | Varnostni lok              | <b>KO</b>  | 범퍼 바                        |
| <b>HR</b> | Štitnik                    | <b>BG</b>  | Броня                       |
| <b>HU</b> | Karfa                      | <b>SR</b>  | Štitnik                     |
| <b>SE</b> | Stötfångare                | <b>MS</b>  | Bar bamper                  |
| <b>NO</b> | Fender                     | <b>HI</b>  | बम्पर बर                    |
| <b>FI</b> | Suojakaari                 | <b>TH</b>  | แถบกันชน                    |
| <b>DA</b> | Sikkerhedsbøjle            | <b>SQ</b>  | Shufra e parakolpit         |
| <b>ET</b> | Turvakaar                  | <b>BS</b>  | Štitnik                     |
| <b>LV</b> | Aizsargloks                | <b>ME</b>  | Štitnik                     |
| <b>LT</b> | Amortizatoriaus<br>strygas | <b>MK</b>  | Одбојник                    |
| <b>RU</b> | Поручень                   | <b>HY</b>  | Թափարգել                    |
| <b>UK</b> | Обмежувальний<br>поручень  | <b>VI</b>  | Thanh chống va đập          |



= 48

|           |                       |            |                       |
|-----------|-----------------------|------------|-----------------------|
| <b>EN</b> | Seat direction        | <b>EL</b>  | Κατεύθυνση καθίσματος |
| <b>DE</b> | Sitzrichtung          | <b>RO</b>  | Direcție scaun        |
| <b>ES</b> | Dirección de la silla | <b>IS</b>  | Sætisstefna           |
| <b>FR</b> | Sens du siège         | <b>MT</b>  | Direzzjoni tas-sit    |
| <b>PT</b> | Orientação do assento | <b>AR</b>  | اتجاه المقعد          |
| <b>IT</b> | Direzione di seduta   | <b>FA</b>  | جهت صندلی             |
| <b>NL</b> | Zitrichting           | <b>YUE</b> | 座椅方向                  |
| <b>PL</b> | Kierunek siedzenia    | <b>CMN</b> | 座椅方向                  |
| <b>CS</b> | Směr sedadla          | <b>JA</b>  | シートの方向                |
| <b>SK</b> | Smer sedadla          | <b>KO</b>  | 좌석 방향                 |
| <b>SL</b> | Smer sedeža           | <b>BG</b>  | Посока на седалката   |
| <b>HR</b> | Smjer sjedala         | <b>SR</b>  | Smer sedišta          |
| <b>HU</b> | Ülésirány             | <b>MS</b>  | Arah kerusi           |
| <b>SE</b> | Sitsriktning          | <b>HI</b>  | सीट दिशा              |
| <b>NO</b> | Seteretning           | <b>TH</b>  | ทิศทางที่นั่ง         |
| <b>FI</b> | Istumasuunta          | <b>SQ</b>  | Drejtimi i ndenjësës  |
| <b>DA</b> | Sæderetning           | <b>BS</b>  | Smjer sjedišta        |
| <b>ET</b> | Istme suund           | <b>ME</b>  | Smjer sjedišta        |
| <b>LV</b> | Sēdekļa virziens      | <b>MK</b>  | Правец на седиште     |
| <b>LT</b> | Kėdutės kryptis       | <b>HY</b>  | Ստամանդի ուղղություն  |
| <b>RU</b> | Направление сиденья   | <b>VI</b>  | Hướng ghế ngồi        |
| <b>UK</b> | Напрямок сидіння      |            |                       |
| <b>TR</b> | Koltuk yönü           |            |                       |



= 49

|           |                   |            |                        |
|-----------|-------------------|------------|------------------------|
| <b>EN</b> | Backrest          | <b>EL</b>  | Πλάτη                  |
| <b>DE</b> | Rückenlehne       | <b>RO</b>  | Spătar                 |
| <b>ES</b> | Respaldo          | <b>IS</b>  | Bak                    |
| <b>FR</b> | Dossier           | <b>MT</b>  | Serħ id-dahar          |
| <b>PT</b> | Encosto de costas | <b>AR</b>  | مسند الظهر             |
| <b>IT</b> | Schienale         | <b>FA</b>  | پشتی                   |
| <b>NL</b> | Rugleuning        | <b>YUE</b> | 靠背                     |
| <b>PL</b> | Oparcie           | <b>CMN</b> | 靠背                     |
| <b>CS</b> | Opěradlo          | <b>JA</b>  | 背もたれ                   |
| <b>SK</b> | Operadlo          | <b>KO</b>  | 등받이                    |
| <b>SL</b> | Naslonjalo        | <b>BG</b>  | Облегалка              |
| <b>HR</b> | Naslon            | <b>SR</b>  | Naslon                 |
| <b>HU</b> | Háttámla          | <b>MS</b>  | Penyangdar belakang    |
| <b>SE</b> | Ryggstöd          | <b>HI</b>  | बैक्रेस्ट              |
| <b>NO</b> | Rygglene          | <b>TH</b>  | พนักพิง                |
| <b>FI</b> | Selkänoja         | <b>SQ</b>  | Mbështetësja e shpinës |
| <b>DA</b> | Ryglæn            | <b>BS</b>  | Naslon                 |
| <b>ET</b> | Seljatugi         | <b>ME</b>  | Naslon                 |
| <b>LV</b> | Atzveltne         | <b>MK</b>  | Наслон за грб          |
| <b>LT</b> | Nugaros atlošas   | <b>HY</b>  | Թիկնակ                 |
| <b>RU</b> | Спинка            | <b>VI</b>  | Phấn tựa lưng          |
| <b>UK</b> | Спинка            |            |                        |
| <b>TR</b> | Arkalık           |            |                        |





|           |                                |            |                       |
|-----------|--------------------------------|------------|-----------------------|
| <b>EN</b> | Sun canopy                     | <b>EL</b>  | Κουκούλα για τον ήλιο |
| <b>DE</b> | Sonnenverdeck                  | <b>RO</b>  | Copertină             |
| <b>ES</b> | Capota para el sol             | <b>IS</b>  | Sólartjald            |
| <b>FR</b> | Pare-soleil                    | <b>MT</b>  | Kopertura mix-xemx    |
| <b>PT</b> | Capota solar                   | <b>AR</b>  | مظلة الشمس            |
| <b>IT</b> | Parasole                       | <b>FA</b>  | سایبان                |
| <b>NL</b> | Zonnekap                       | <b>YUE</b> | 遮陽蓬                   |
| <b>PL</b> | Oslona przeciwsłoneczna        | <b>CMN</b> | 遮阳蓬                   |
| <b>CS</b> | Stříška proti slunci           | <b>JA</b>  | 日よけカバー                |
| <b>SK</b> | Strieška proti slnku           | <b>KO</b>  | 선 캐노피                 |
| <b>SL</b> | Senčnik za zaščito pred soncem | <b>BG</b>  | Тента                 |
| <b>HR</b> | Tenda za sunce                 | <b>SR</b>  | Tenda za sunce        |
| <b>HU</b> | Kupola                         | <b>MS</b>  | Kanopi matahari       |
| <b>SE</b> | Solsufflett                    | <b>HI</b>  | धूप छतरी              |
| <b>NO</b> | Solskjerm                      | <b>TH</b>  | หลังคาบังแดด          |
| <b>FI</b> | Aurinkokatot                   | <b>SQ</b>  | Strea për diellin     |
| <b>DA</b> | Solkaleche                     | <b>BS</b>  | Tenda za sunce        |
| <b>ET</b> | Päikesevari                    | <b>ME</b>  | Tenda za sunce        |
| <b>LV</b> | Saules aizsegs                 | <b>MK</b>  | Стреа за сонце        |
| <b>LT</b> | Stogelis nuo saulės            | <b>HY</b>  | Սրահապաշտպան ծածկ     |
| <b>RU</b> | Солнцезащитный козырек         | <b>VI</b>  | Mái che nắng          |
| <b>UK</b> | Тент від сонця                 |            |                       |
| <b>TR</b> | Güneş başlığı                  |            |                       |

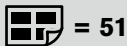

|           |                    |            |                   |
|-----------|--------------------|------------|-------------------|
| <b>EN</b> | Handle bar         | <b>EL</b>  | Ράβρος λαβής      |
| <b>DE</b> | Schiebegriff       | <b>RO</b>  | Mâner             |
| <b>ES</b> | Manillar           | <b>IS</b>  | Handfang          |
| <b>FR</b> | Poignée de poussée | <b>MT</b>  | Handle bar        |
| <b>PT</b> | Guiador            | <b>AR</b>  | عارضة المقبض      |
| <b>IT</b> | Manubrio           | <b>FA</b>  | میله دسته         |
| <b>NL</b> | Duwstang           | <b>YUE</b> | 把手                |
| <b>PL</b> | Uchwyt             | <b>CMN</b> | 把手                |
| <b>CS</b> | Madlo              | <b>JA</b>  | ハンドルバー            |
| <b>SK</b> | Rukoväť            | <b>KO</b>  | 핸들 바              |
| <b>SL</b> | Ročaj              | <b>BG</b>  | Кормило           |
| <b>HR</b> | Ručice             | <b>SR</b>  | Ručke             |
| <b>HU</b> | Tolókar            | <b>MS</b>  | Bar pemegang      |
| <b>SE</b> | Handtag            | <b>HI</b>  | हैंडल बार         |
| <b>NO</b> | Håndtak            | <b>TH</b>  | ด้ามจับ           |
| <b>FI</b> | Työntökahva        | <b>SQ</b>  | Shufra e dorezës  |
| <b>DA</b> | Styr               | <b>BS</b>  | Ručice            |
| <b>ET</b> | Sang               | <b>ME</b>  | Ručke             |
| <b>LV</b> | Rokturis           | <b>MK</b>  | Рачка             |
| <b>LT</b> | Rankena            | <b>HY</b>  | Կարալվարման բռնակ |
| <b>RU</b> | Рукоятка           | <b>VI</b>  | Tay cãm           |
| <b>UK</b> | Рукоятка           |            |                   |
| <b>TR</b> | Tutma sapı         |            |                   |





 = 54

|           |                        |            |                           |
|-----------|------------------------|------------|---------------------------|
| <b>EN</b> | Removing the fabric    | <b>TR</b>  | Kilifi çıkarma            |
| <b>DE</b> | Entfernen des Bezuges  | <b>EL</b>  | Αφαίρεση του υφάσματος    |
| <b>ES</b> | Quitar la tela         | <b>RO</b>  | Îndepărtarea țesăturii    |
| <b>FR</b> | Retrait du tissu       | <b>IS</b>  | Fjarlægja efni            |
| <b>PT</b> | Remover o tecido       | <b>MT</b>  | Tnehhija tad-drapp        |
| <b>IT</b> | Rimozione del tessuto  | <b>AR</b>  | فك القماش                 |
| <b>NL</b> | De stof verwijderen    | <b>FA</b>  | برداشتن پارچه             |
| <b>PL</b> | Zdejmowanie pokrycia   | <b>YUE</b> | 拆除罩布                      |
| <b>CS</b> | Odstranění látky       | <b>CMN</b> | 拆除罩布                      |
| <b>SK</b> | Odstránenie látky      | <b>JA</b>  | カバーの取り外し                  |
| <b>SL</b> | Odstranjevanje blaga   | <b>KO</b>  | 페브릭 제거                    |
| <b>HR</b> | Uklanjanje tkanine     | <b>BG</b>  | Демонтиране на плата      |
| <b>HU</b> | Huzat eltávolítása     | <b>SR</b>  | Uklanjanje tkanine        |
| <b>SE</b> | Ta bort tyget          | <b>MS</b>  | Menanggalkan fabrik       |
| <b>NO</b> | Fjerne stoffet         | <b>HI</b>  | कपड़ा हटाना               |
| <b>FI</b> | Kankaan poisto         | <b>TH</b>  | การถอดผ้า                 |
| <b>DA</b> | Fjernelse af stoffet   | <b>SQ</b>  | Heqja e copës             |
| <b>ET</b> | Kanga eemaldamine      | <b>BS</b>  | Uklanjanje tkanine        |
| <b>LV</b> | Pārklājuma atvienošana | <b>ME</b>  | Uklanjanje tkanine        |
| <b>LT</b> | Audinio nuėmimas       | <b>MK</b>  | Отстранување на навлаката |
| <b>RU</b> | Снятие ткани           | <b>HY</b>  | Գործվածքը հանելը          |
| <b>UK</b> | Зняття матерії         | <b>VI</b>  | Tháo phần vải bọc         |



 = 60

|           |                        |            |                           |
|-----------|------------------------|------------|---------------------------|
| <b>EN</b> | Removing the fabric    | <b>EL</b>  | Αφαίρεση του υφάσματος    |
| <b>DE</b> | Entfernen des Bezuges  | <b>RO</b>  | Îndepărtarea țesăturii    |
| <b>ES</b> | Quitar la tela         | <b>IS</b>  | Fjarlægja efni            |
| <b>FR</b> | Retrait du tissu       | <b>MT</b>  | Tnehhija tad-drapp        |
| <b>PT</b> | Remover o tecido       | <b>AR</b>  | فك القماش                 |
| <b>IT</b> | Rimozione del tessuto  | <b>FA</b>  | برداشتن پارچه             |
| <b>NL</b> | De stof verwijderen    | <b>YUE</b> | 拆除罩布                      |
| <b>PL</b> | Zdejmowanie pokrycia   | <b>CMN</b> | 拆除罩布                      |
| <b>CS</b> | Odstranění látky       | <b>JA</b>  | カバーの取り外し                  |
| <b>SK</b> | Odstránenie látky      | <b>KO</b>  | 페브릭 제거                    |
| <b>SL</b> | Odstranjevanje blaga   | <b>BG</b>  | Демонтиране на плата      |
| <b>HR</b> | Uklanjanje tkanine     | <b>SR</b>  | Uklanjanje tkanine        |
| <b>HU</b> | Huzat eltávolítása     | <b>MS</b>  | Menanggalkan fabrik       |
| <b>SE</b> | Ta bort tyget          | <b>HI</b>  | कपड़ा हटाना               |
| <b>NO</b> | Fjerne stoffet         | <b>TH</b>  | การถอดผ้า                 |
| <b>FI</b> | Kankaan poisto         | <b>SQ</b>  | Heqja e copës             |
| <b>DA</b> | Fjernelse af stoffet   | <b>BS</b>  | Uklanjanje tkanine        |
| <b>ET</b> | Kanga eemaldamine      | <b>ME</b>  | Uklanjanje tkanine        |
| <b>LV</b> | Pārklājuma atvienošana | <b>MK</b>  | Отстранување на навлаката |
| <b>LT</b> | Audinio nuėmimas       | <b>HY</b>  | Գործվածքը հանելը          |
| <b>RU</b> | Снятие ткани           | <b>VI</b>  | Tháo phần vải bọc         |
| <b>UK</b> | Зняття матерії         |            |                           |
| <b>TR</b> | Kilifi çıkarma         |            |                           |



 = 70

|           |                                |            |                                 |
|-----------|--------------------------------|------------|---------------------------------|
| <b>EN</b> | Infant Car Seat                | <b>TR</b>  | Bebek Araba Koltuğu             |
| <b>DE</b> | Babyschale                     | <b>EL</b>  | Παιδικό κάθισμα αυτοκινήτου     |
| <b>ES</b> | Silla infantil para coche      | <b>RO</b>  | Scaunul auto pentru infant      |
| <b>FR</b> | Siège auto pour enfant         | <b>IS</b>  | Smábarnabilstóll                |
| <b>PT</b> | Cadeira auto infantil          | <b>MT</b>  | Sit tal-Karozza tat-Tfal        |
| <b>IT</b> | Seggiolino per auto            | <b>AR</b>  | مقعد سيارة للرضع                |
| <b>NL</b> | Autostoeltje                   | <b>FA</b>  | صندلی خودرو برای نوزاد          |
| <b>PL</b> | Fotelik dla niemowlaka         | <b>YUE</b> | 嬰兒汽車座椅                          |
| <b>CS</b> | Vajičko                        | <b>CMN</b> | 婴儿汽车座椅                          |
| <b>SK</b> | Autosedačka pre dojčatá        | <b>JA</b>  | 幼児用カーシート                        |
| <b>SL</b> | Avtosedež za dojenčke          | <b>KO</b>  | 유아용 카시트                         |
| <b>HR</b> | Autosjedalica za bebe          | <b>BG</b>  | Бибешка седалка за автомобил    |
| <b>HU</b> | Gyermekek autósülés            | <b>SR</b>  | Auto sedište za bebe            |
| <b>SE</b> | Bilbarnstol                    | <b>MS</b>  | Kerusi Keselamatan Bayi         |
| <b>NO</b> | Barnebilsete                   | <b>HI</b>  | शिशु कार सीट                    |
| <b>FI</b> | Lasten istuin                  | <b>TH</b>  | คาร์ซีทสำหรับเด็กทารก           |
| <b>DA</b> | Autostol                       | <b>SQ</b>  | Sexholino                       |
| <b>ET</b> | Imiku turvatool                | <b>BS</b>  | Auto sjedište za bebe           |
| <b>LV</b> | Zidaiņu sēdekļis               | <b>ME</b>  | Auto sjedište za bebe           |
| <b>LT</b> | Automobilinė naujagimio kėdutė | <b>MK</b>  | Детско седиште за автомобил     |
| <b>RU</b> | Детское автокресло             | <b>HY</b>  | Վնդոսիքներնայի մանկական նստատեղ |
| <b>UK</b> | Автокрісло для немовлят        | <b>VI</b>  | Ghế xe dành cho trẻ sơ sinh     |



 = 72

|           |                        |            |                     |
|-----------|------------------------|------------|---------------------|
| <b>EN</b> | Rain cover             | <b>EL</b>  | Καλύπτρα βροχής     |
| <b>DE</b> | Regenverdeck           | <b>RO</b>  | Prelată de ploaie   |
| <b>ES</b> | Funda para la lluvia   | <b>IS</b>  | Regn yfirbreiðsla   |
| <b>FR</b> | Housse de pluie        | <b>MT</b>  | Għata mix-xita      |
| <b>PT</b> | Capa de chuva          | <b>AR</b>  | غطاء المطر          |
| <b>IT</b> | Parapioggia            | <b>FA</b>  | روکش باران          |
| <b>NL</b> | Regenhoes              | <b>YUE</b> | 防雨罩                 |
| <b>PL</b> | Oslona od deszczu      | <b>CMN</b> | 防雨罩                 |
| <b>CS</b> | Pláštěnka              | <b>JA</b>  | 雨よけ                 |
| <b>SK</b> | Kryt proti dažďu       | <b>KO</b>  | 레인커버                |
| <b>SL</b> | Dežna prevleka         | <b>BG</b>  | Дъждобран           |
| <b>HR</b> | Pokrivač za kišu       | <b>SR</b>  | Pokrivač za kišu    |
| <b>HU</b> | Esővédő                | <b>MS</b>  | Pelindung hujan     |
| <b>SE</b> | Regnskydd              | <b>HI</b>  | रेन कवर             |
| <b>NO</b> | Kalesje                | <b>TH</b>  | ผ้าคลุมกันฝน        |
| <b>FI</b> | Sadesuoja              | <b>SQ</b>  | Mbulesë për shiun   |
| <b>DA</b> | Regnslag               | <b>BS</b>  | Pokrivač za kišu    |
| <b>ET</b> | Vihmakate              | <b>ME</b>  | Pokrivač za kišu    |
| <b>LV</b> | Pretlietus pārvalks    | <b>MK</b>  | Прекиривка за дожд  |
| <b>LT</b> | Uždangalas nuo lietaus | <b>HY</b>  | Վնծրակապաշտպան ծածկ |
| <b>RU</b> | Дождевик               | <b>VI</b>  | Tấm che mưa         |
| <b>UK</b> | Дошовик                |            |                     |
| <b>TR</b> | Yağmurluk              |            |                     |

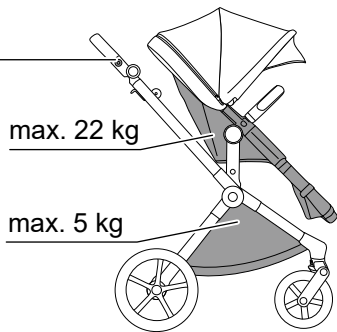
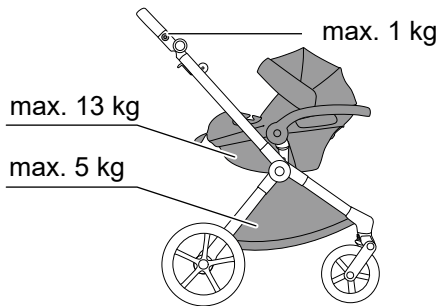
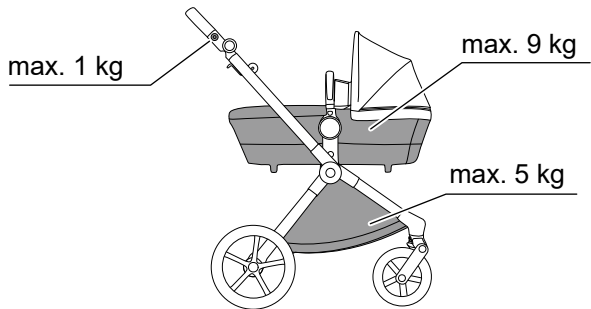

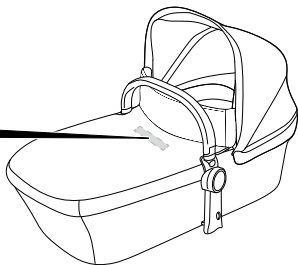
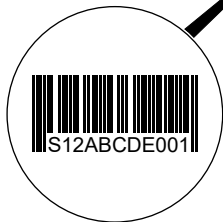
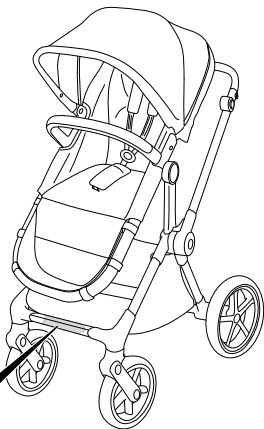

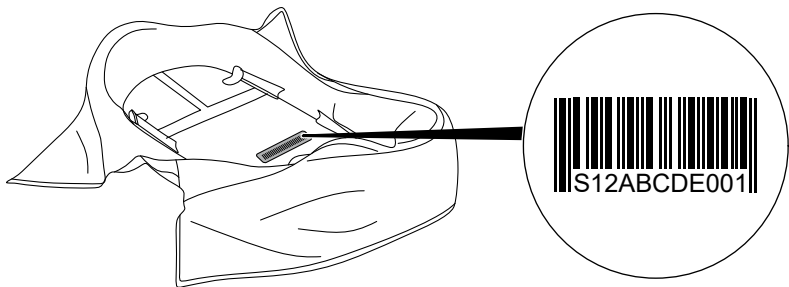

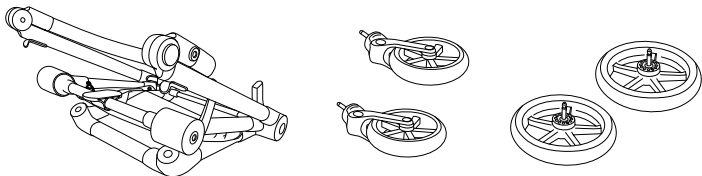
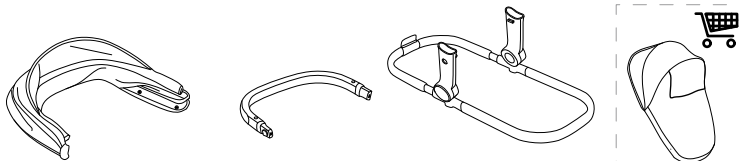
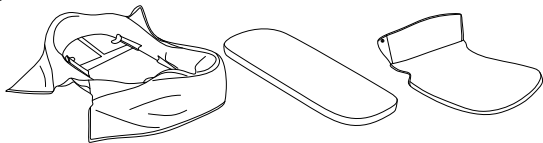
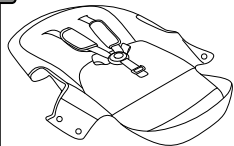
**A****B****C****D**



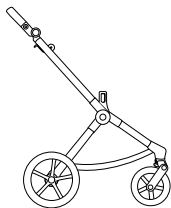

**A**

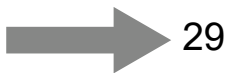

29

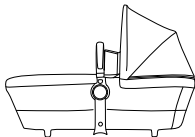

**B + C**



21

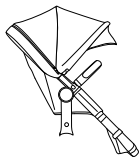

**B + D**

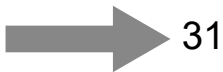

31



**A**

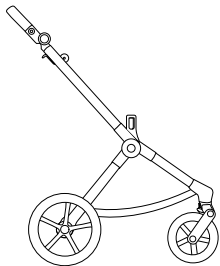

**1**

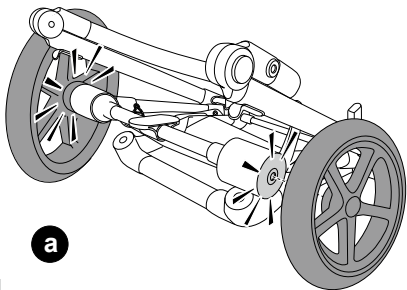

**a**

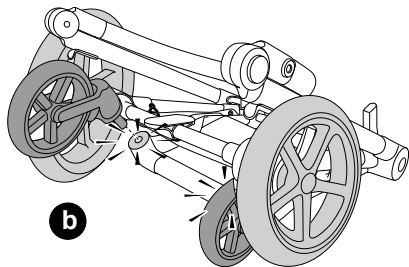

**b**

**2**



**a**

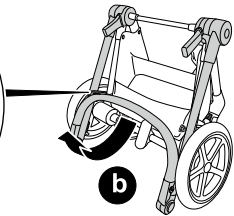
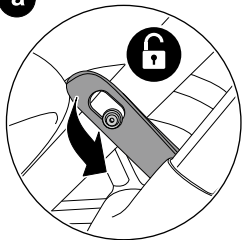

**c**

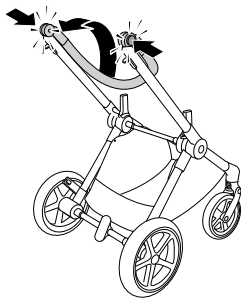

**3**

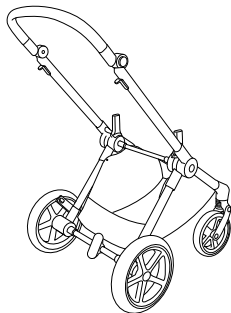

**4**

**B** + **C**

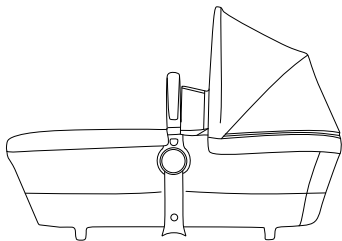

5

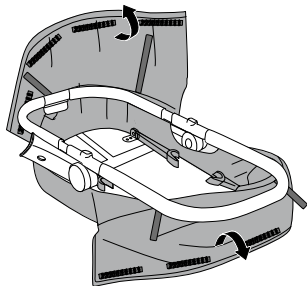
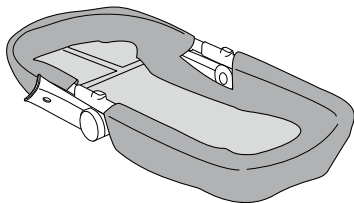

6

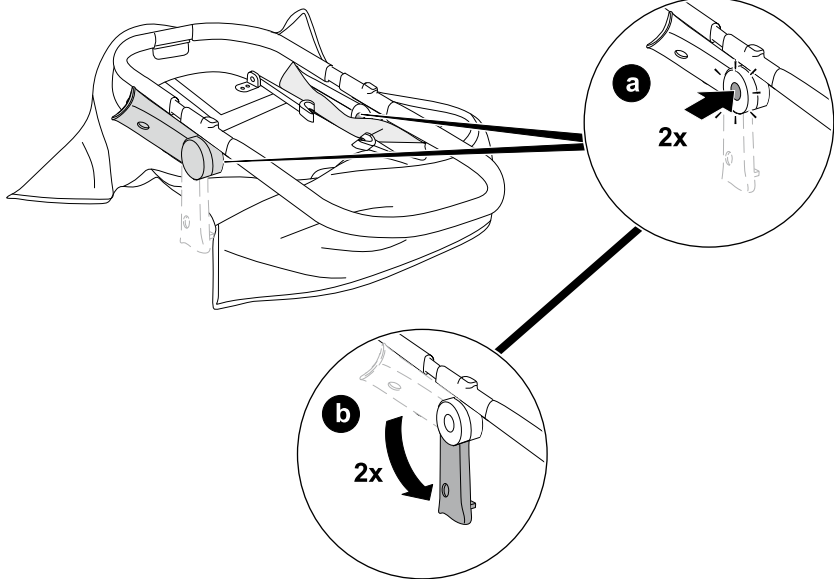

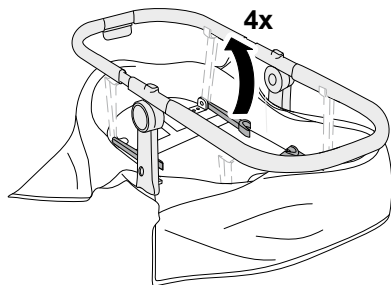

8

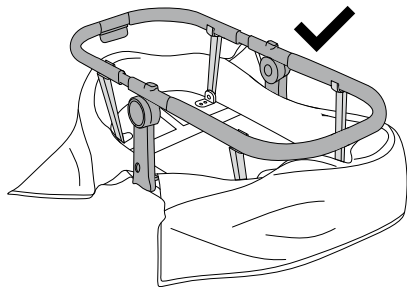

9

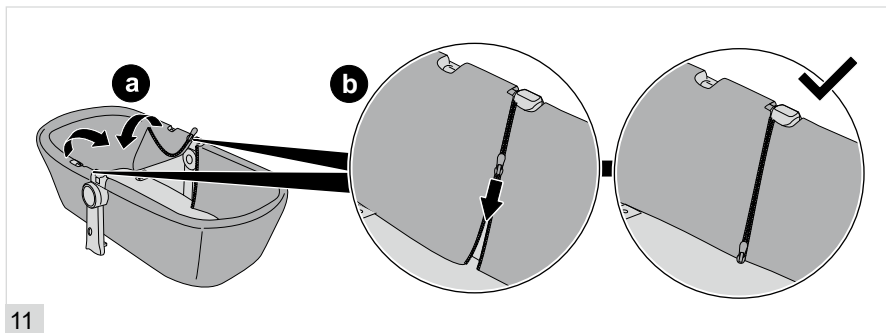
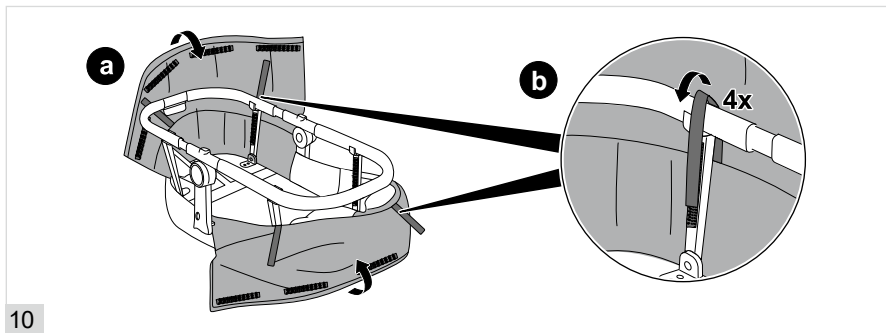

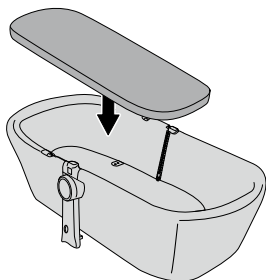

12

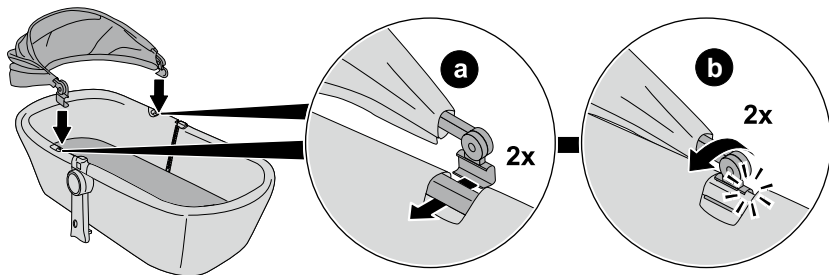

24

13



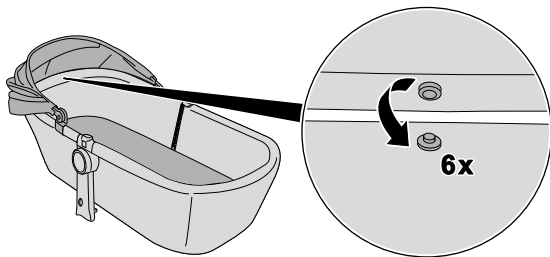

14

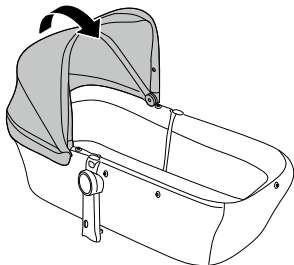

15

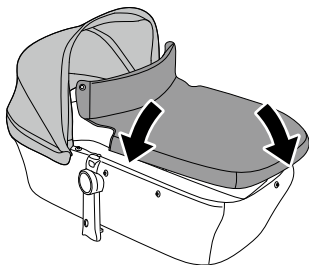

16

25

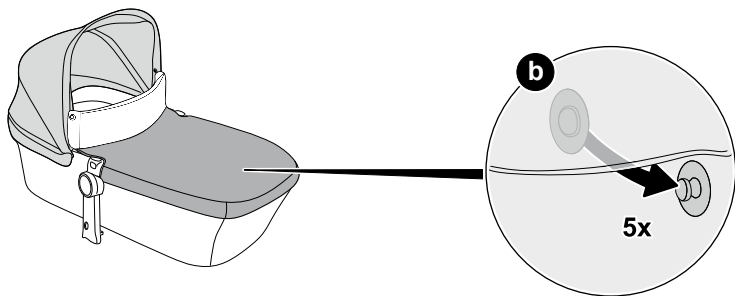
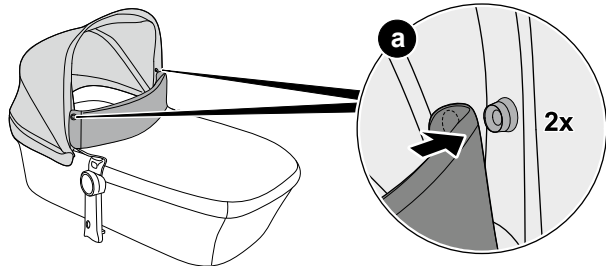

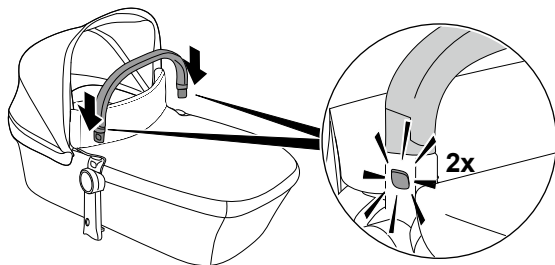

18

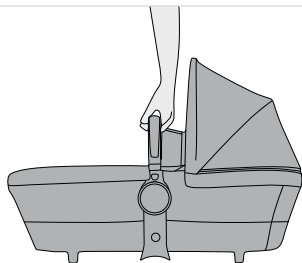

19

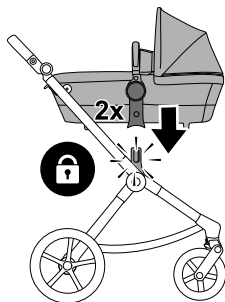

27

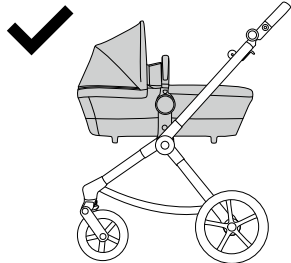
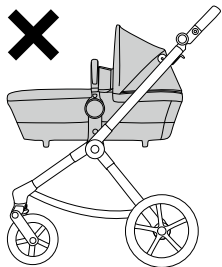

20

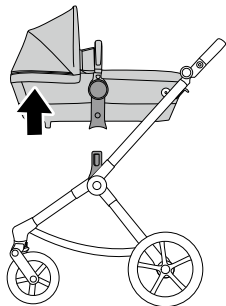
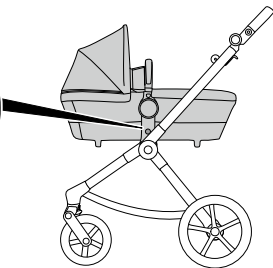
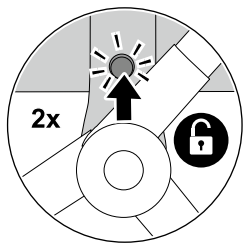

28

21



**B + D**

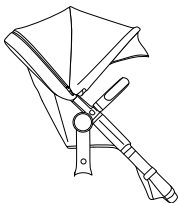

22

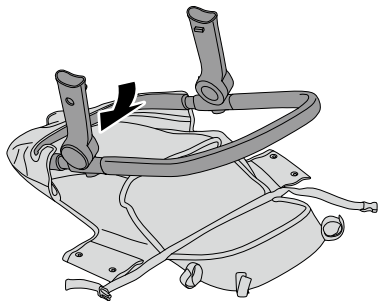

23

29

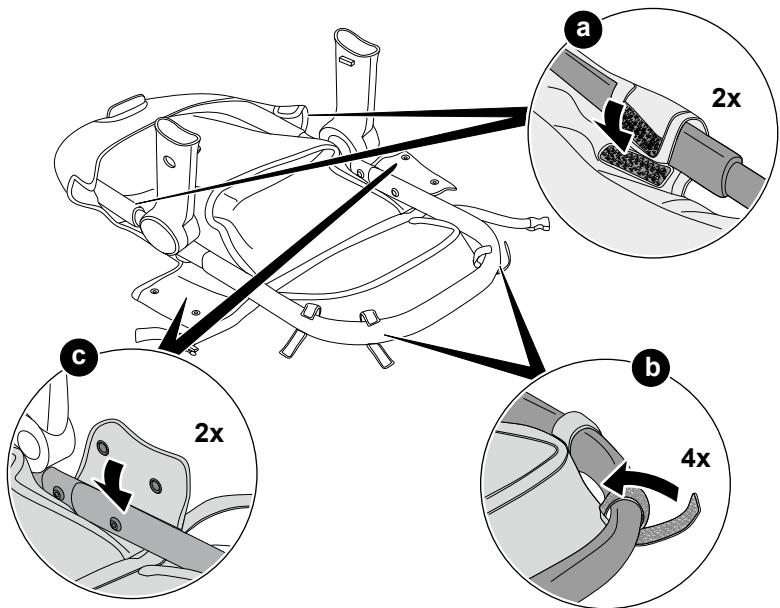

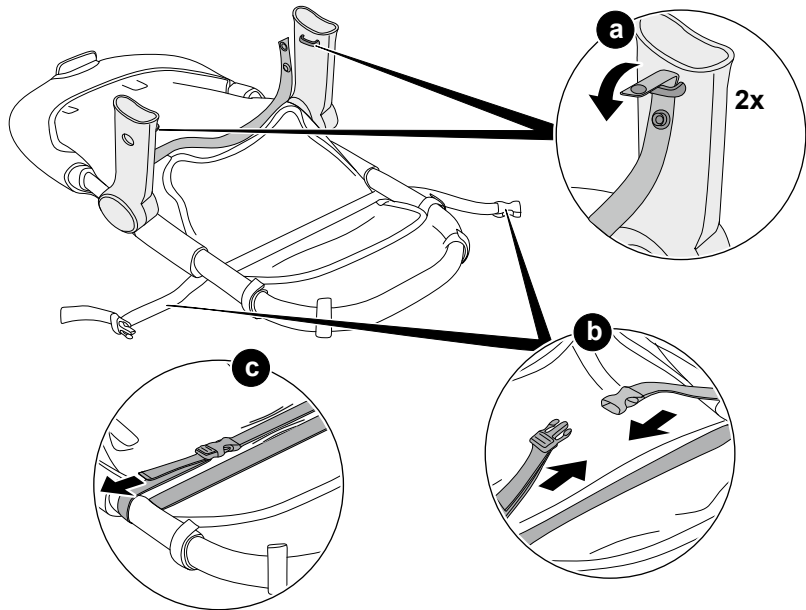

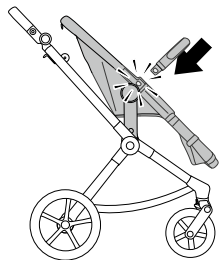
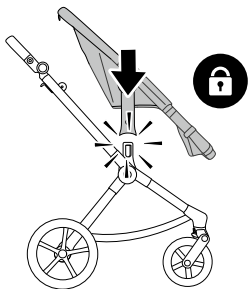

26

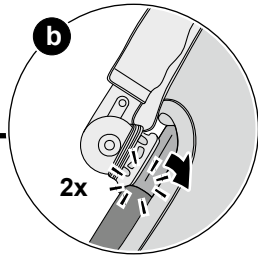
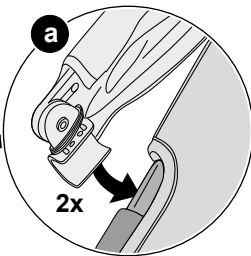
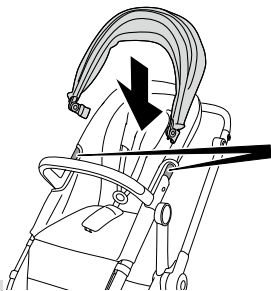

32

27



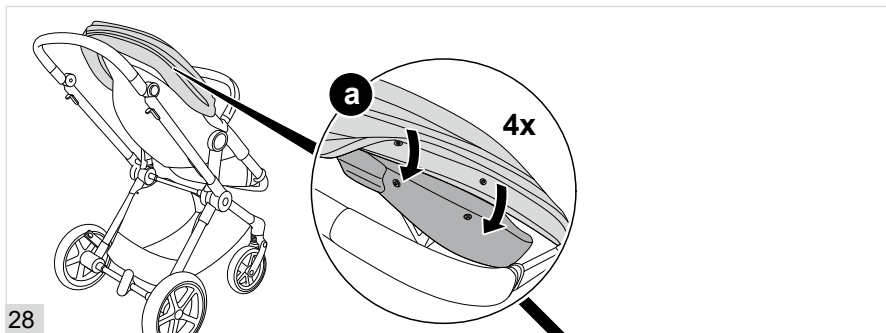

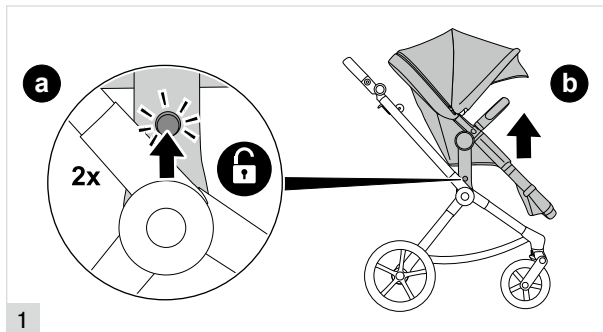
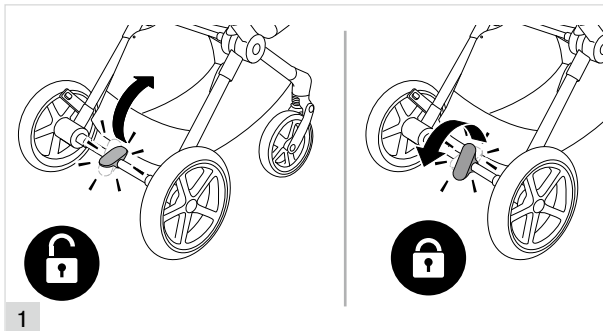

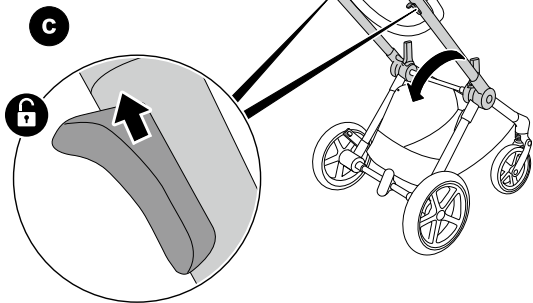
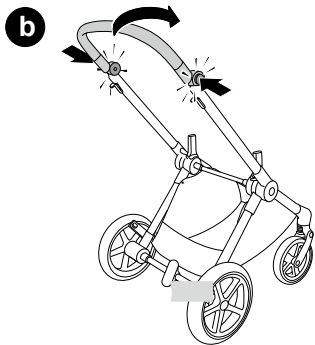



d

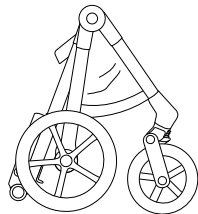
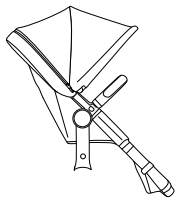
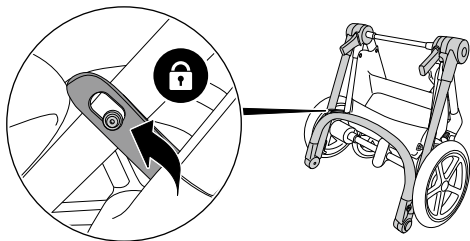

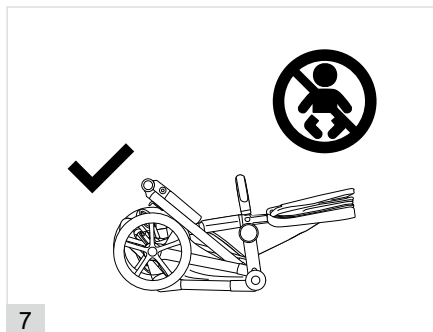
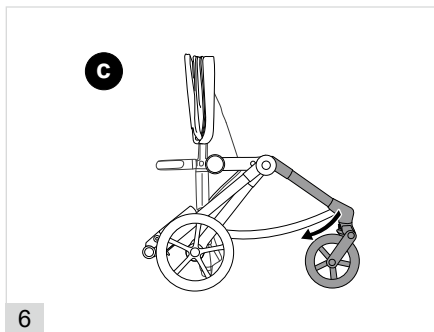
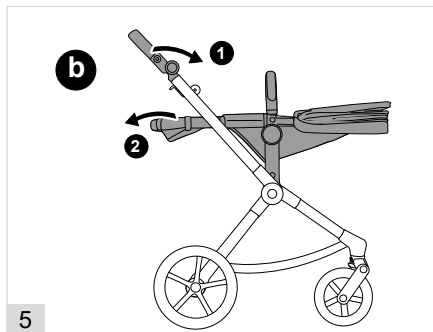
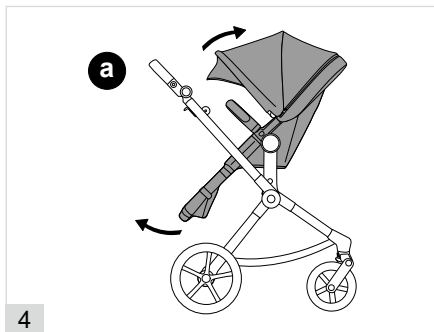



**a**

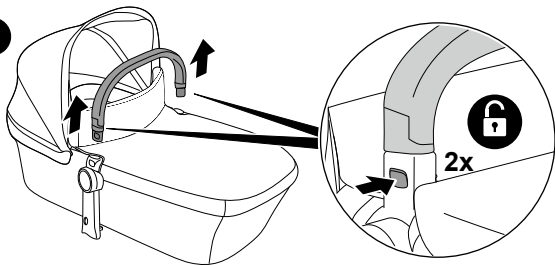

**1**

**b**

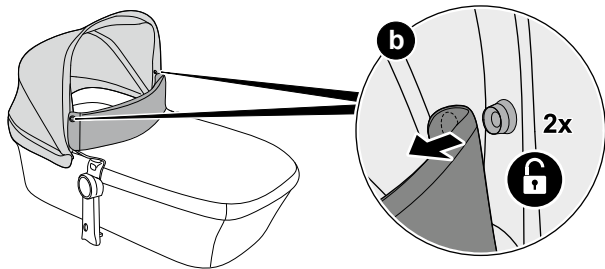

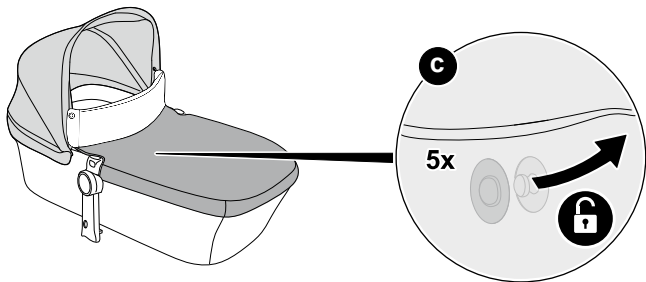

3

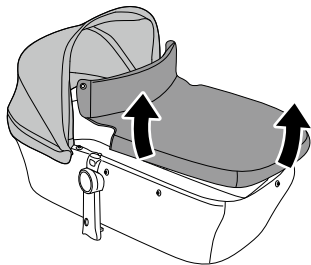

4

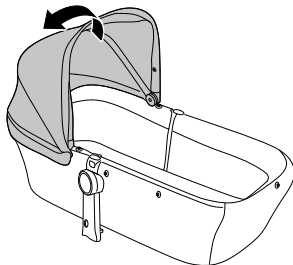

5



**a**

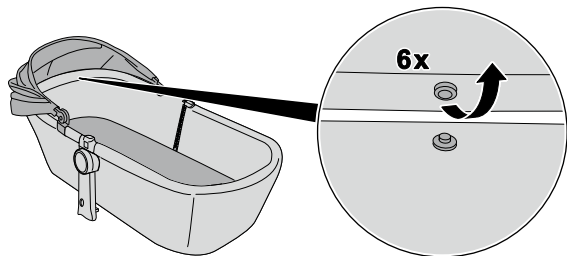

6

**b**

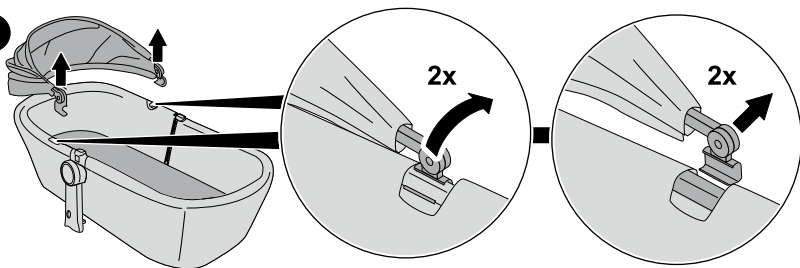

7



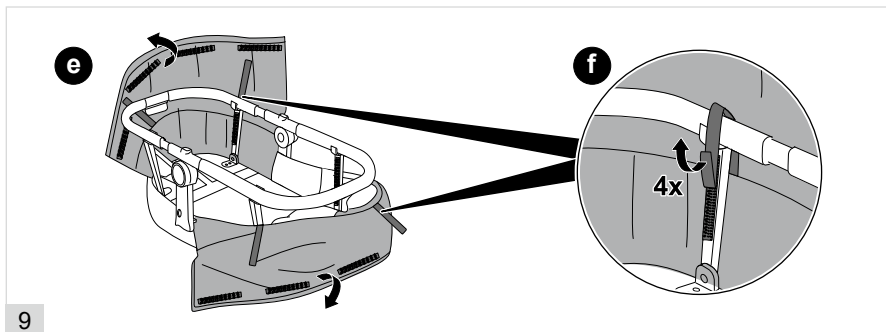
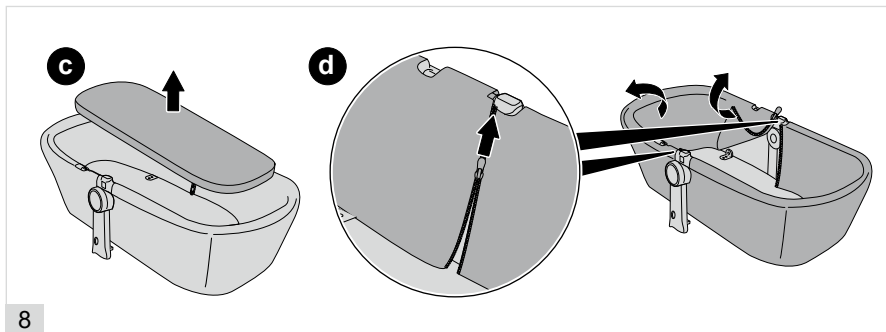

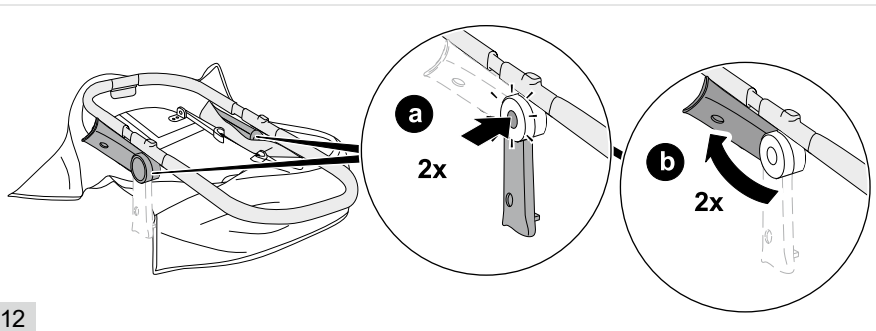
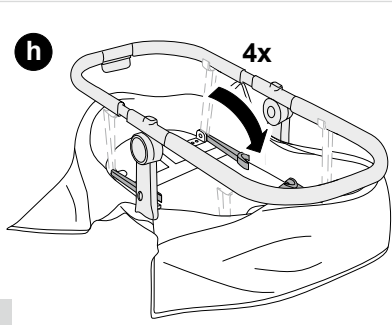
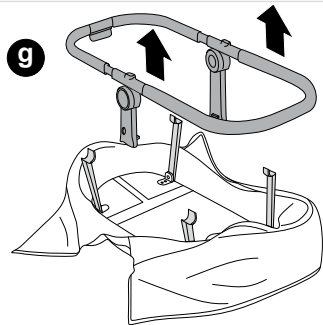

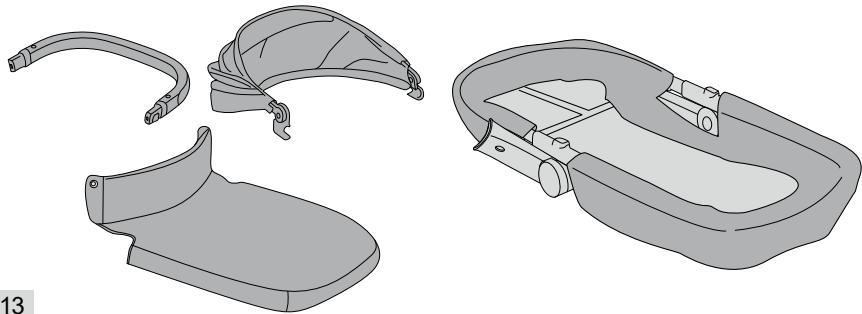

13



1

a

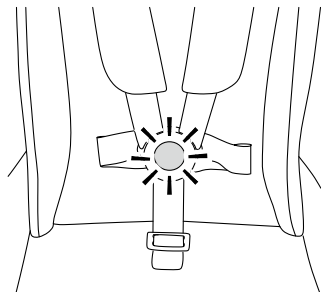

b

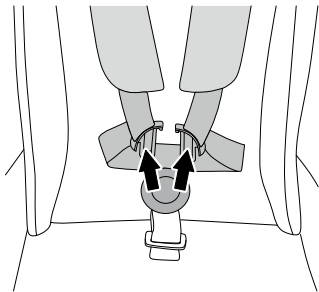

c

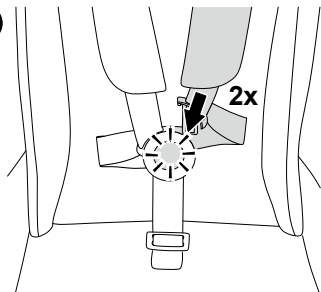



**d**

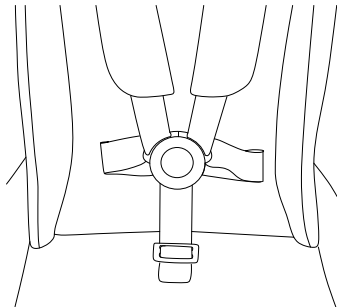

**3**

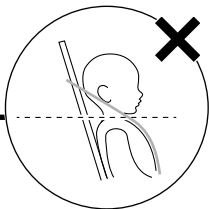
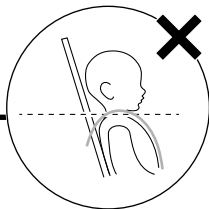
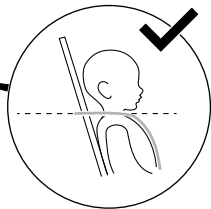
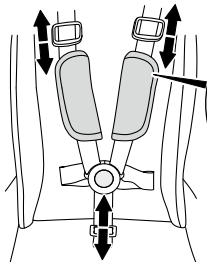

**4**

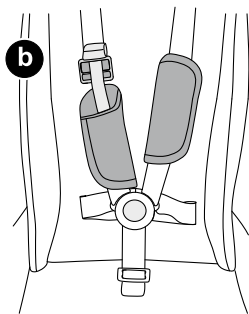
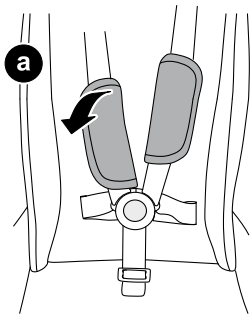

5

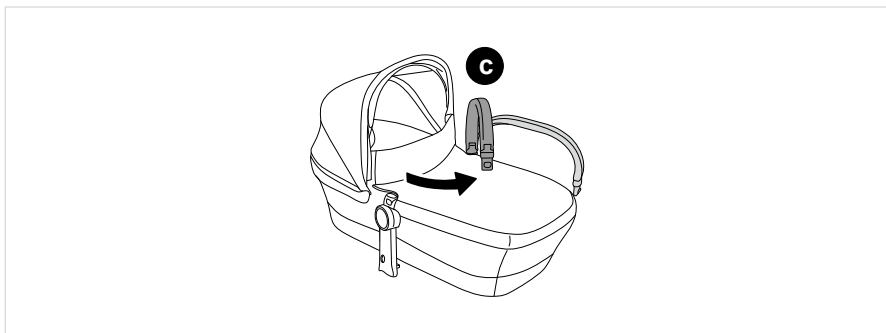
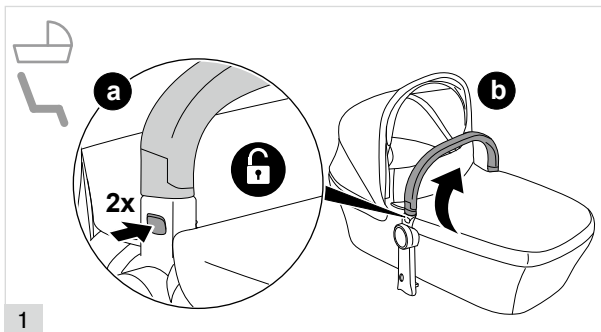

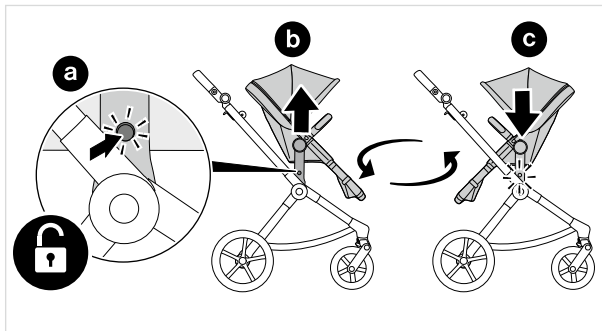



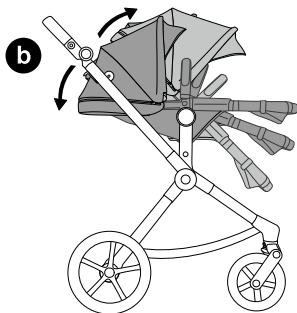
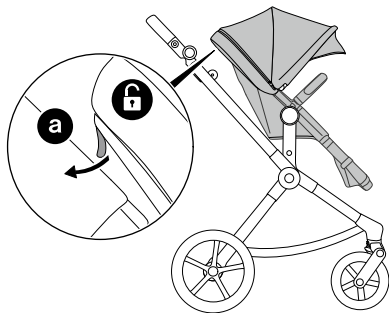

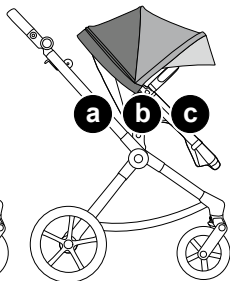
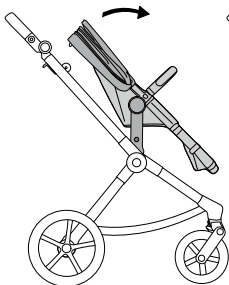

1

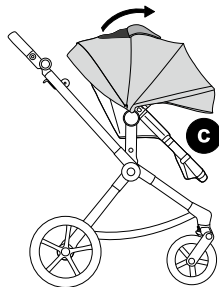
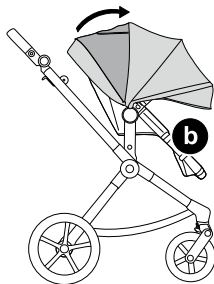
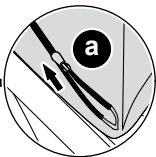
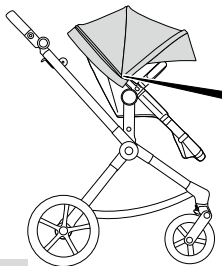

2

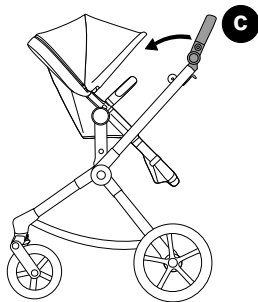
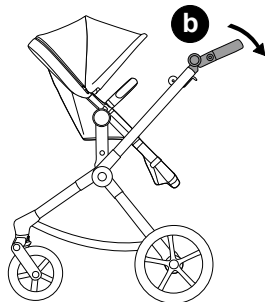
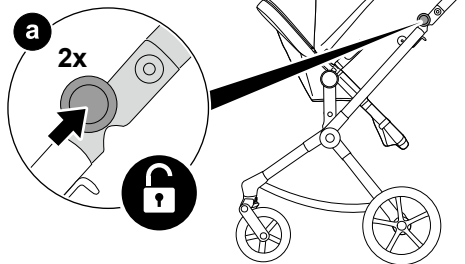



1

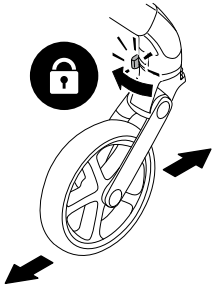
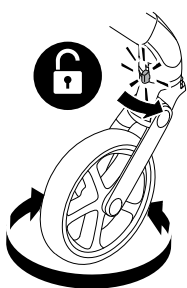

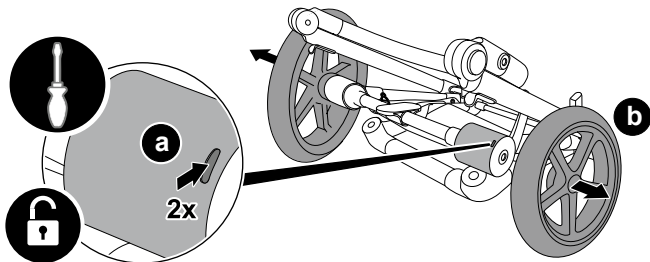
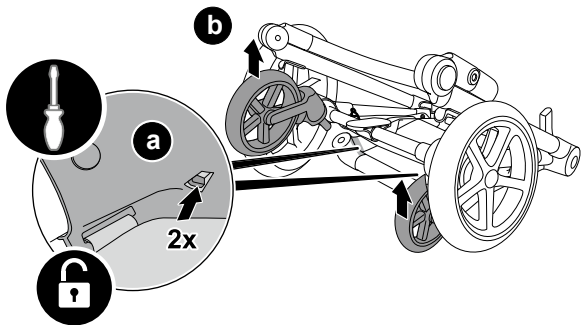

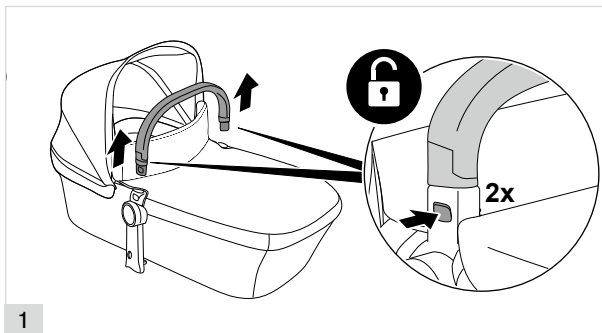

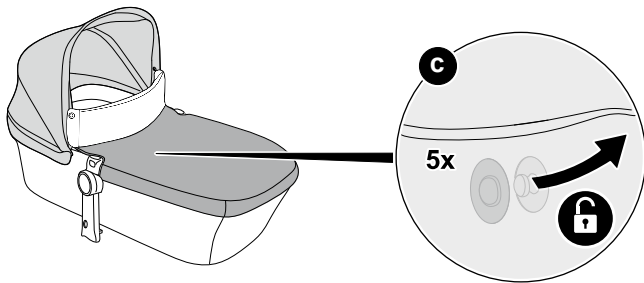
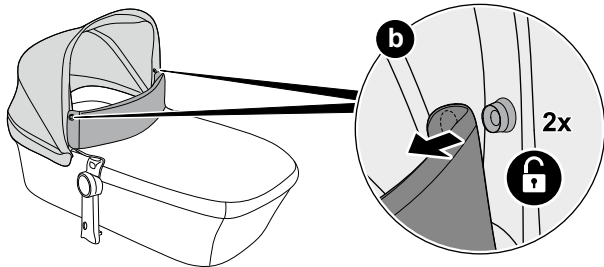

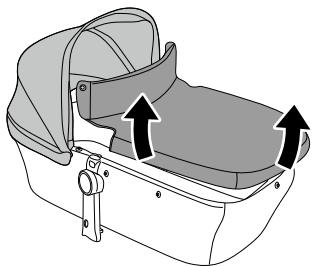

3

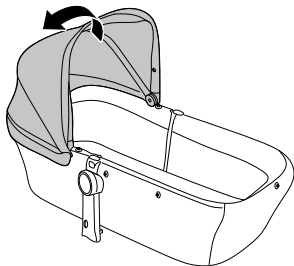

4

**a**

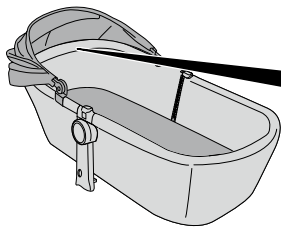

6x

5



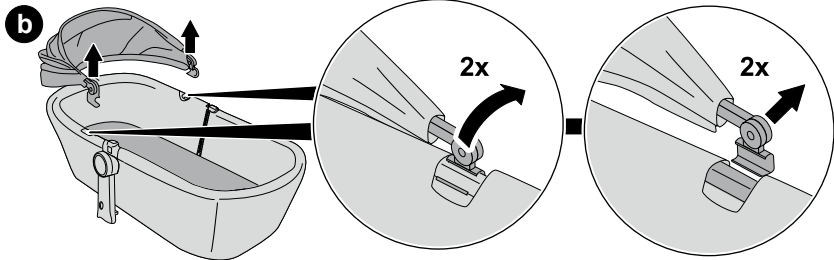

6

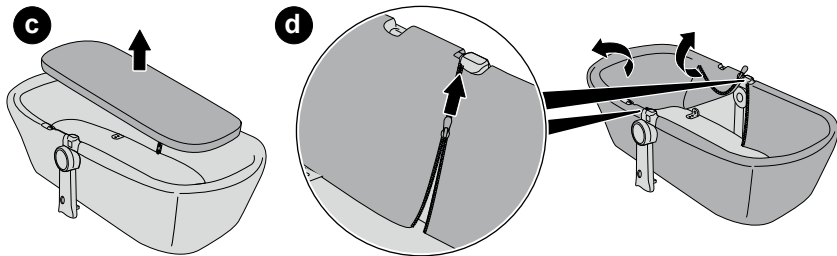

7

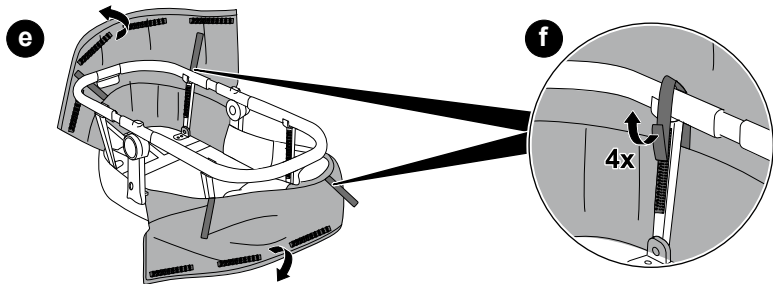

8

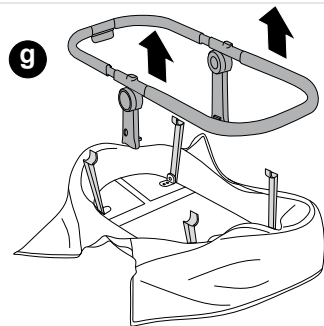

9

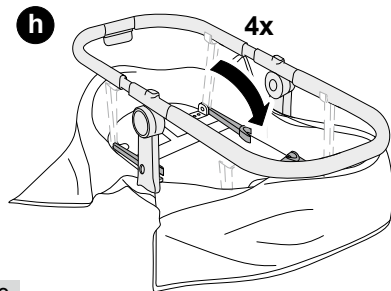

10

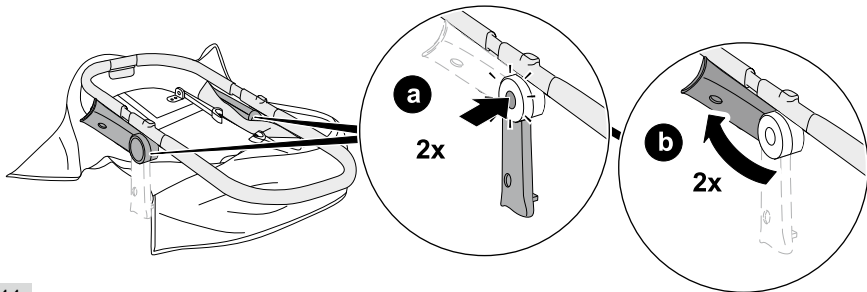

11

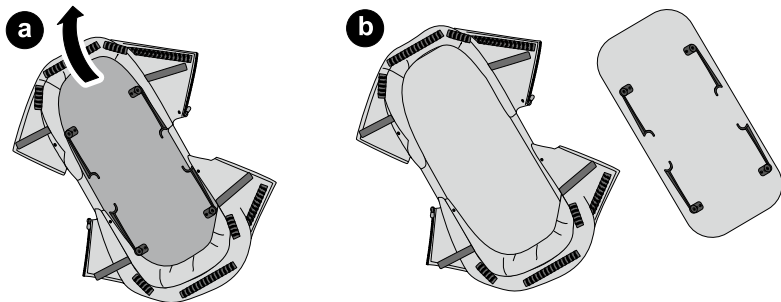

12

59

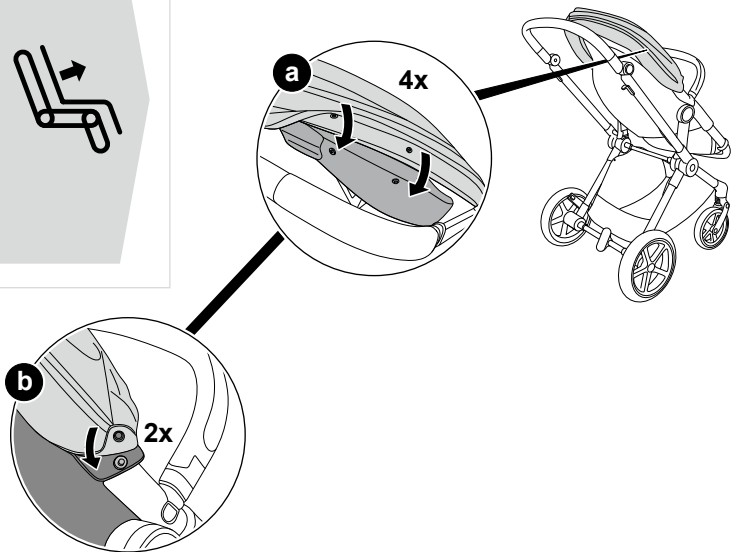

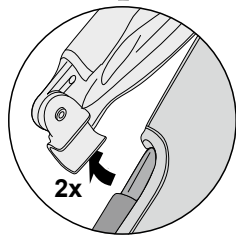
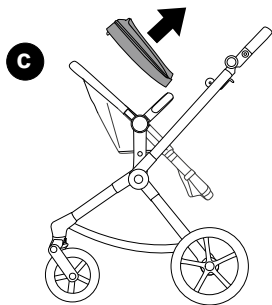
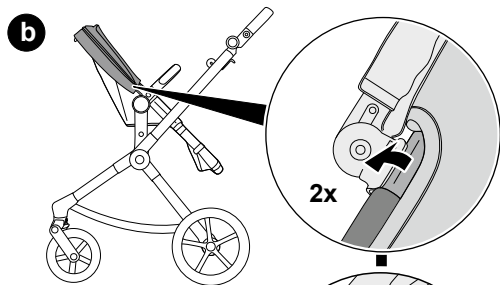
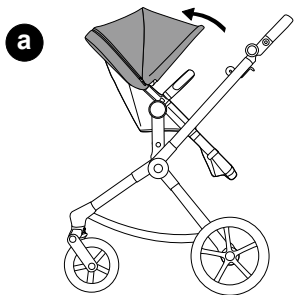



**d**

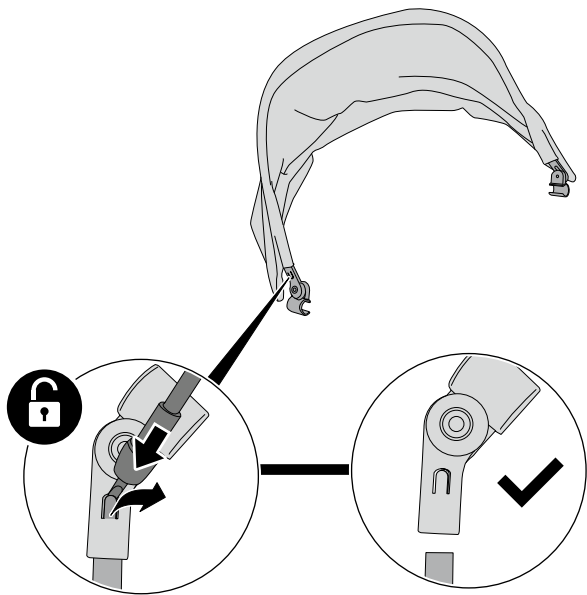

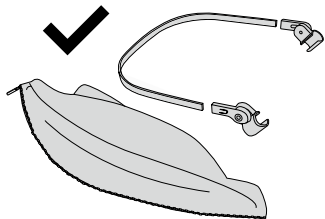
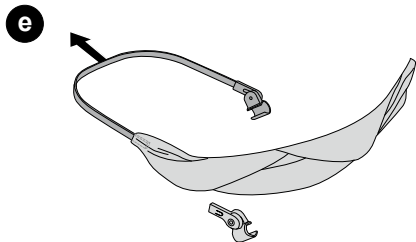

4

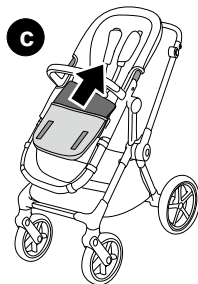
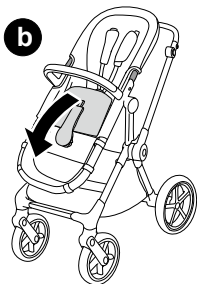

5

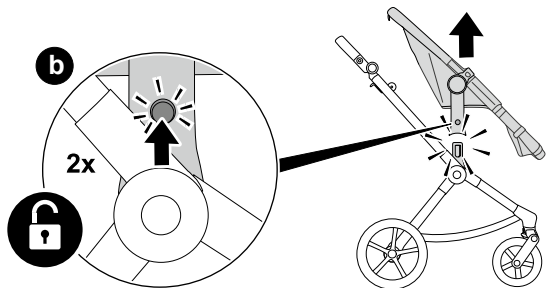
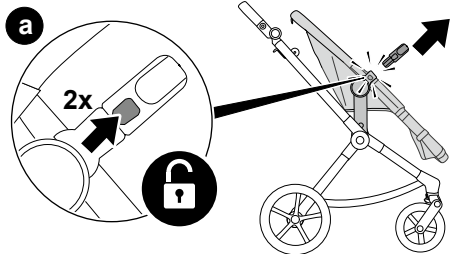



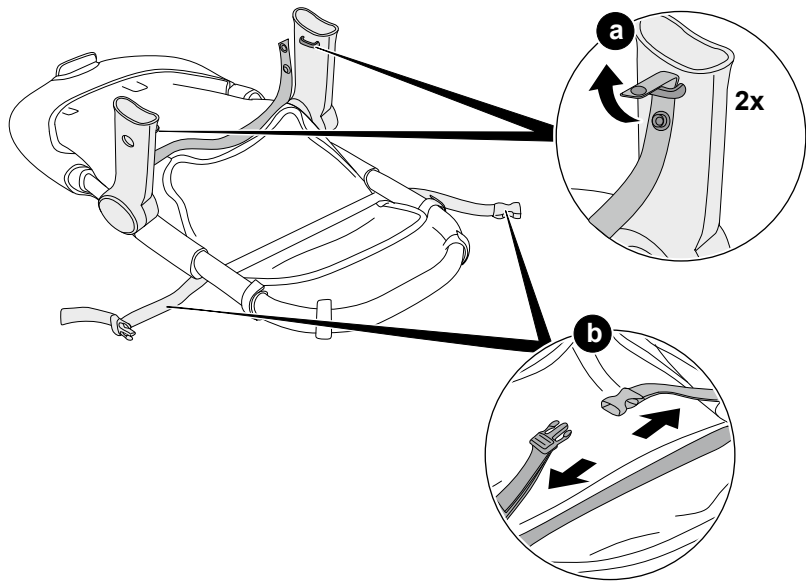

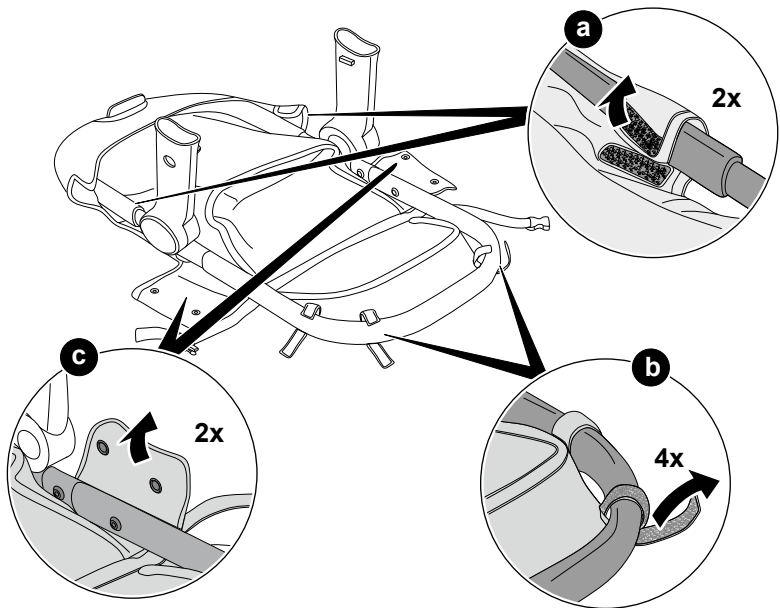

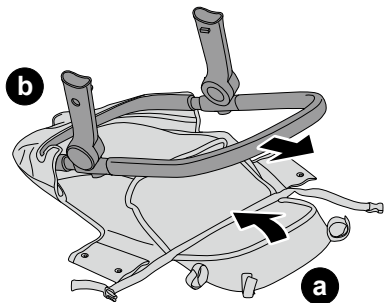

9

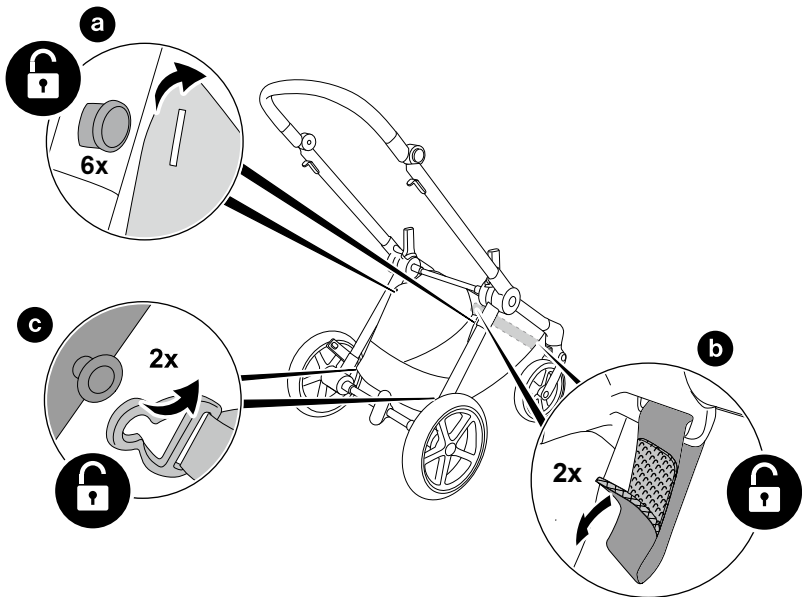

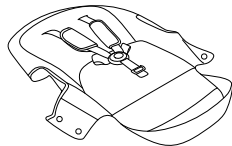
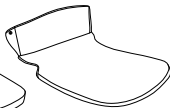
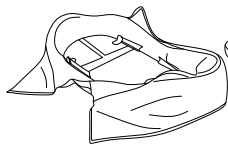
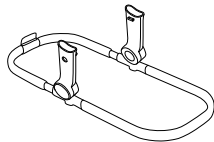
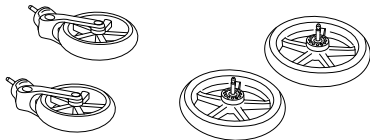
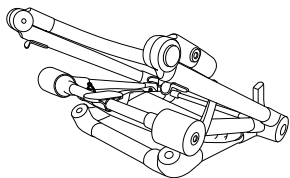

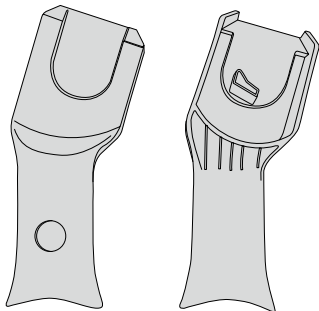

1

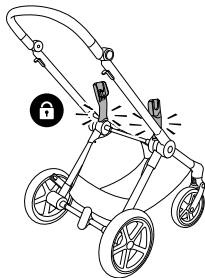
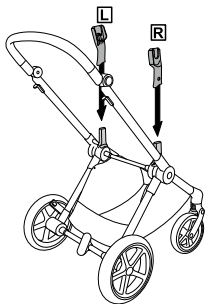

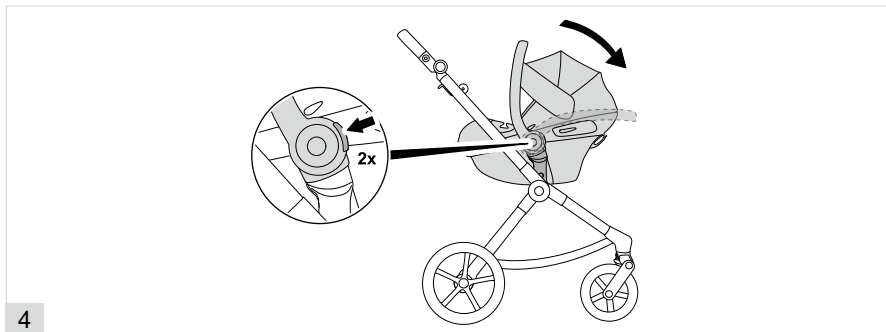

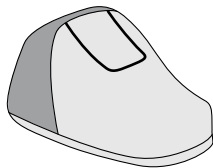

1

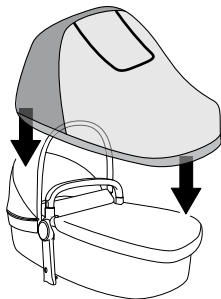



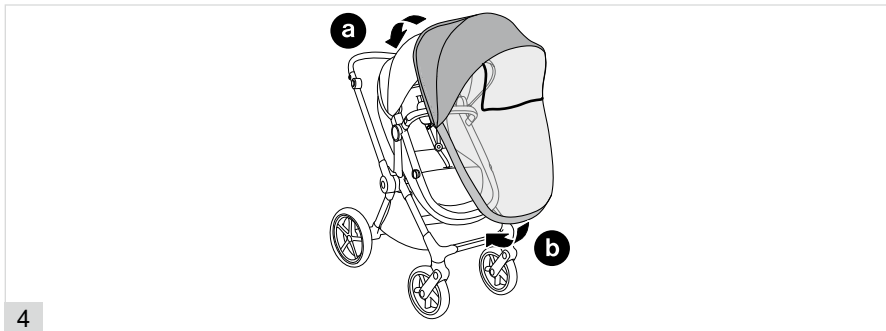
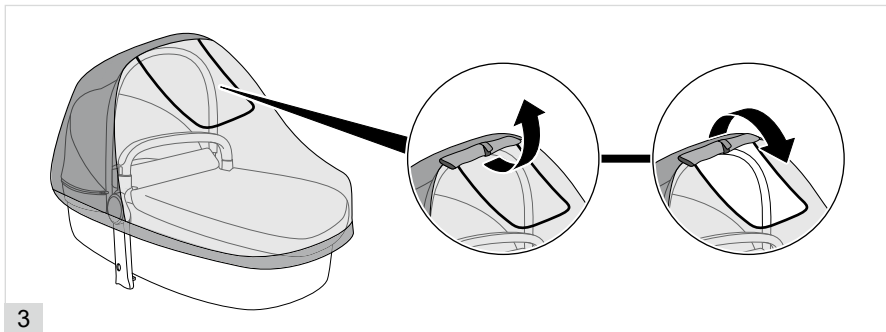

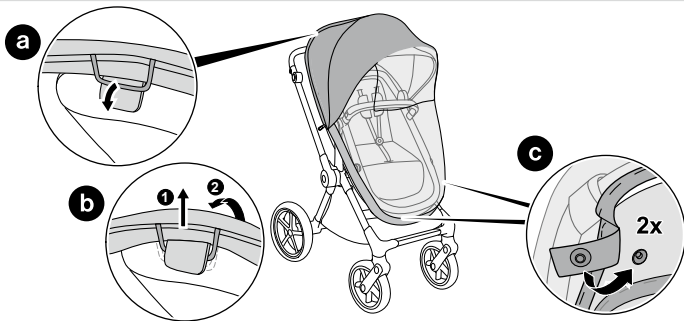



CYBEX GmbH  
Riedingerstr. 18 | 95448 Bayreuth | Germany  
+49 (0) 921-78 511-0 | info@cybex-online.com

[www.cybex-online.com](http://www.cybex-online.com)

 cybex



**FR**  
Cet appareil  
et ses accessoires  
se recyclent

REPRISE  
À LA LIVRAISON

À DÉPOSER  
EN MAGASIN

À DÉPOSER  
EN DÉCHÈTERIE

 OU  OU 

Points de collecte sur [www.quefairedemesdechets.fr](http://www.quefairedemesdechets.fr)