

(D) Montageanleitung

(GB) Assembly instructions

(CZ) Montážní návod

(SK) Návod na montáž

(FR) Notice de montage

(IT) Istruzioni di montaggio

(HU) Szerelési útmutató

(RU) Инструкция по монтажу

(NL) Handleiding voor de montage

(PL) Instrukcja montażu

(TR) Montaj talimatı

(RU) Инструкция по монтажу



"HILTON"



E D

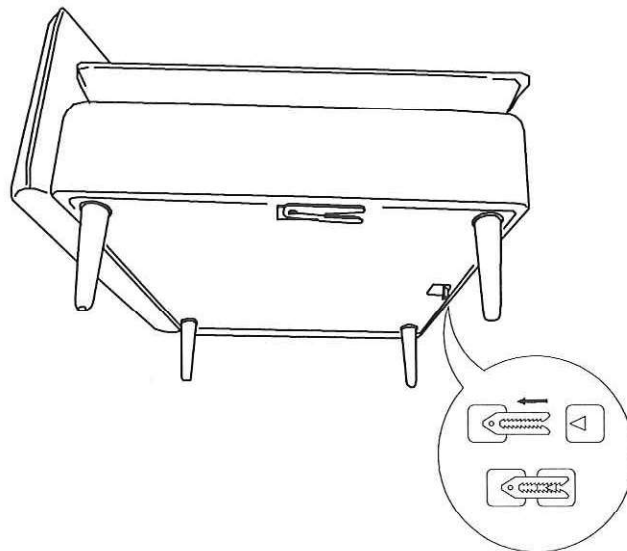
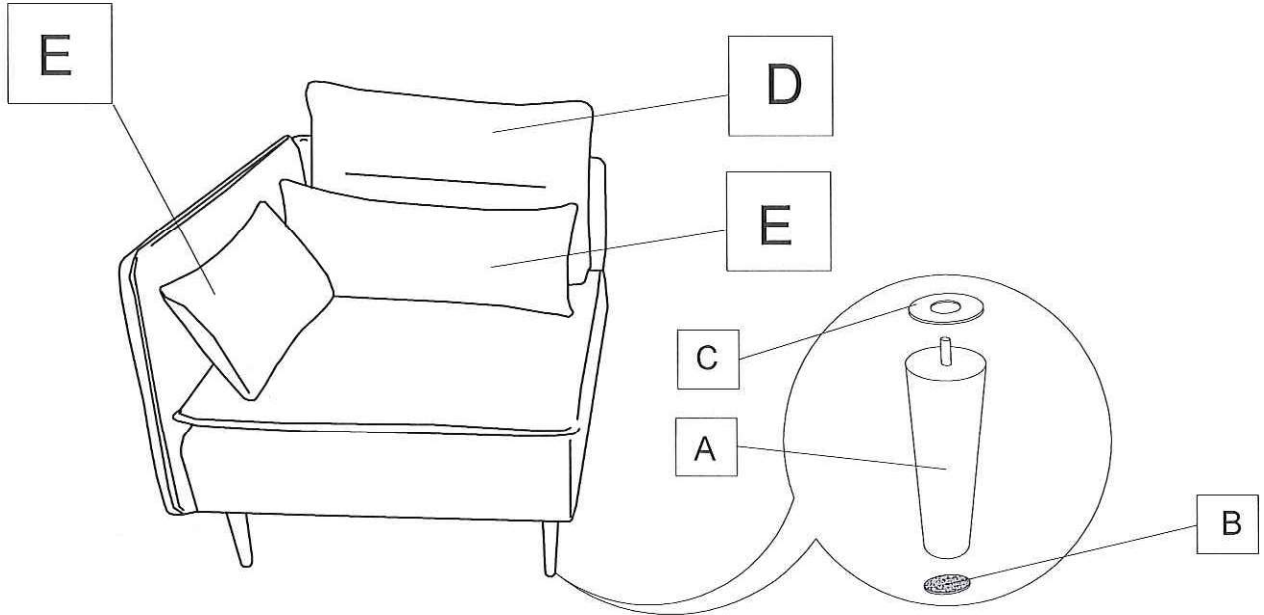
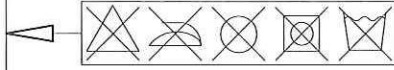

A		x4	B		x4	C		x4	D		x1	E		x2
---	--	----	---	--	----	---	--	----	---	--	----	---	--	----

Service * Assistenza * Dienstverlening * Serwis * Servis * Szerviz * Сервисная служба

Name * Nom * Nome * Naaz * Nazwa * Jméno
 Názov * Név * Denumire * Isim * Название

"HILTON"

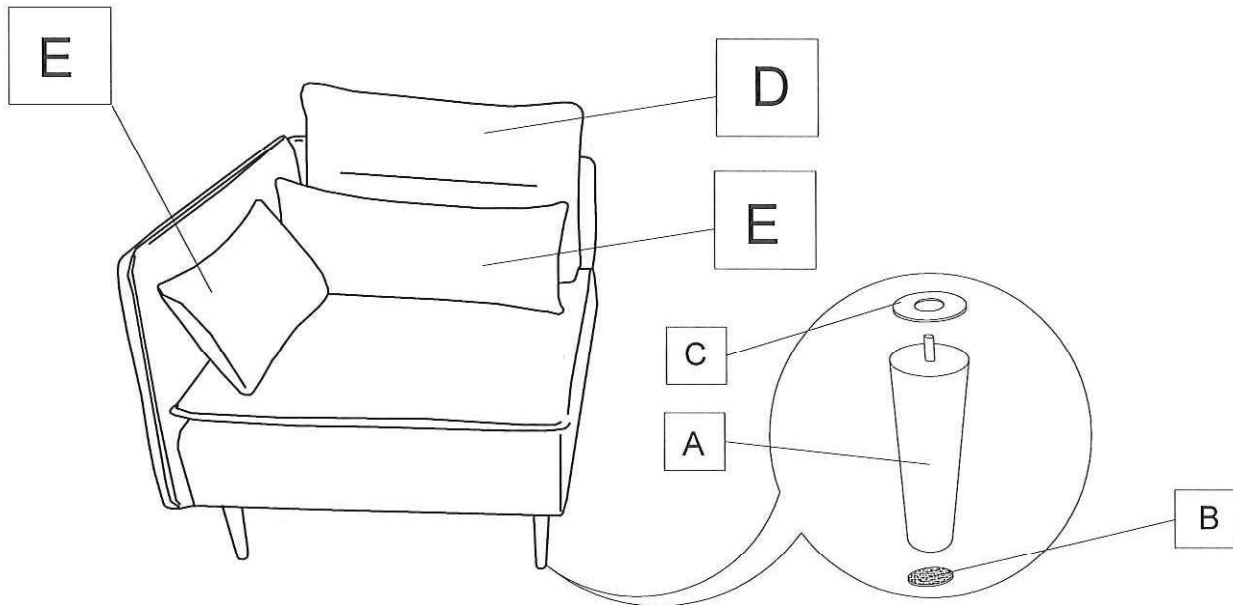
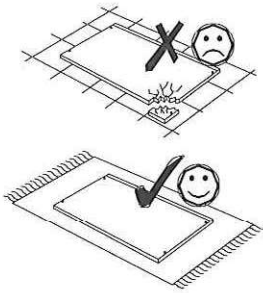
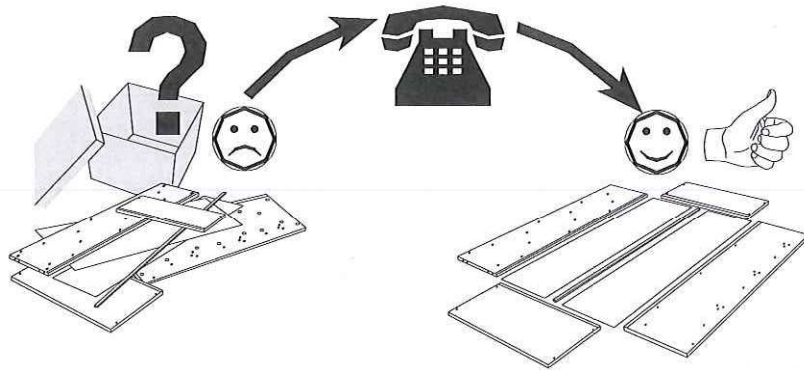
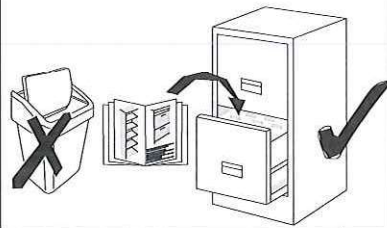

A	B	C	D	E
X....	X....	X....	X....	X....