

A	B	C1	C2	C3	D
1	S544-2001	500	230	22	1/1
2	S544-4501A	898	200	16	1/1
3	S544-3001	300	213	16	1/1
4	S544-4502	880	200	16	1/1

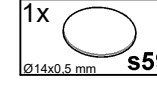

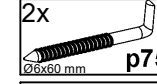

2

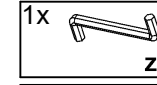
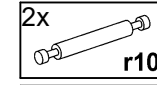
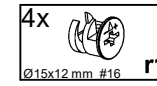
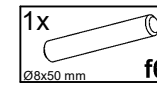
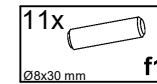
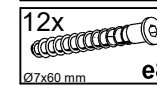
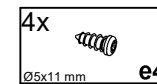
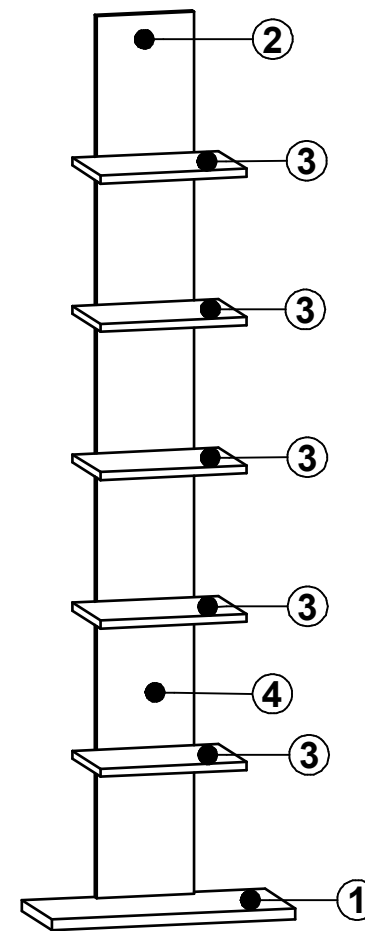
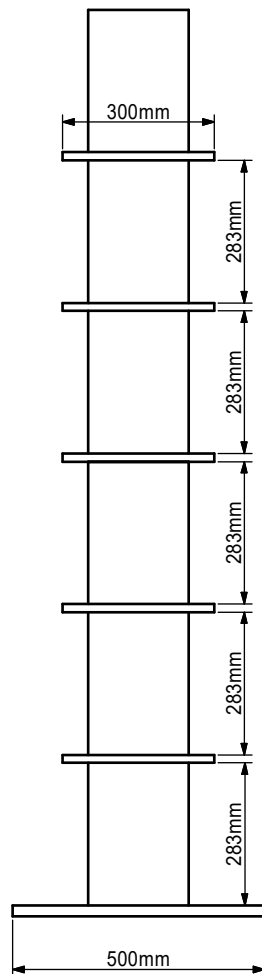
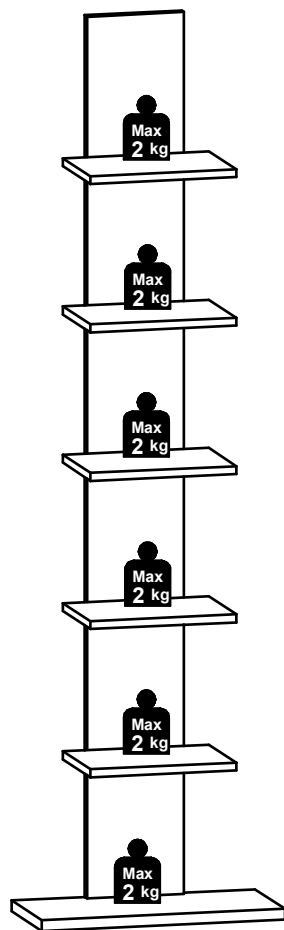
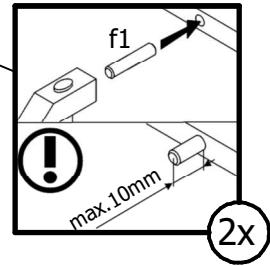
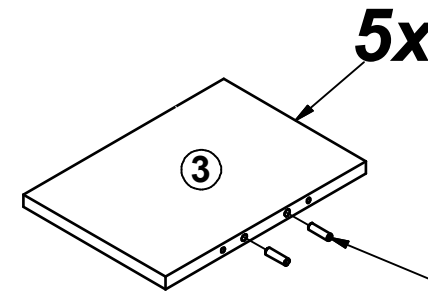
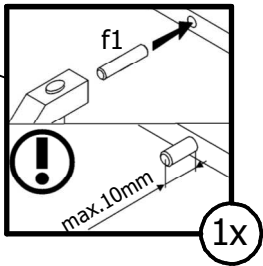
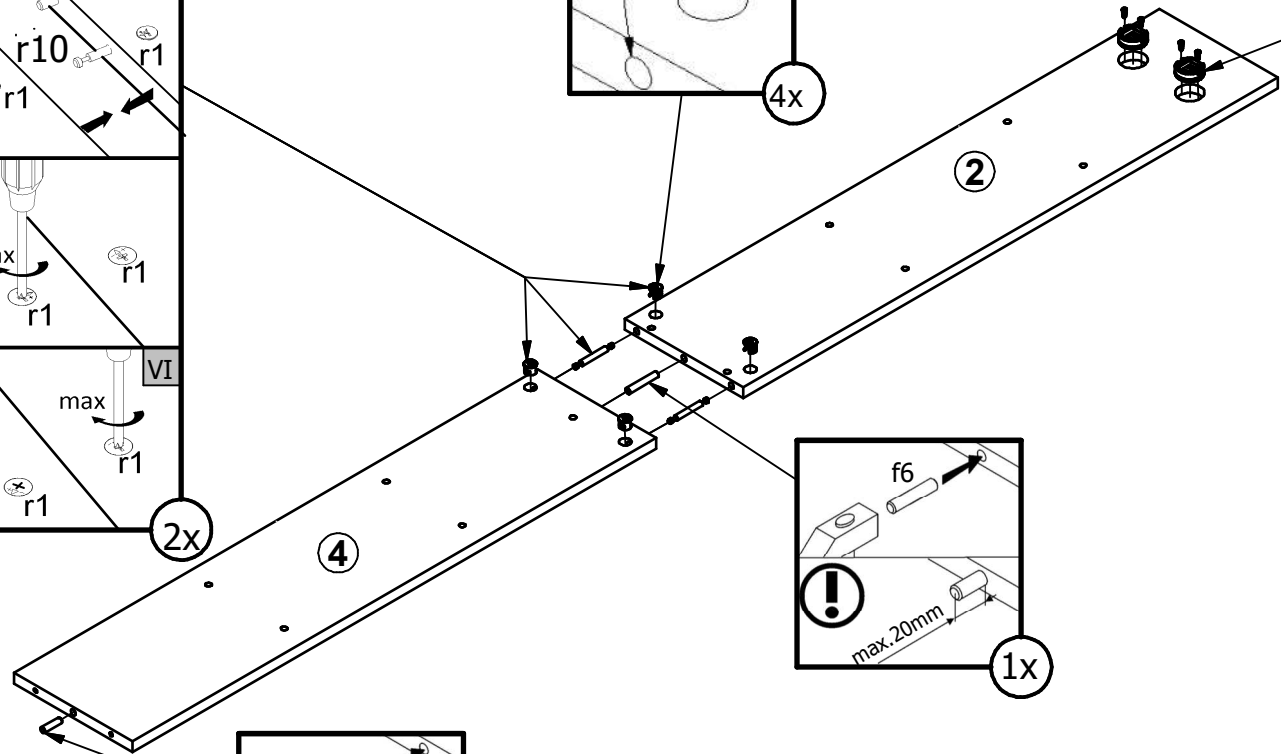
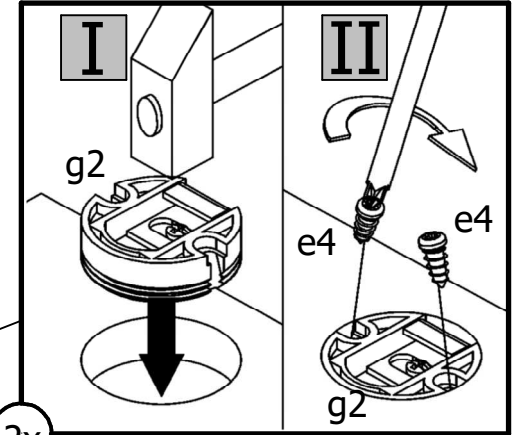
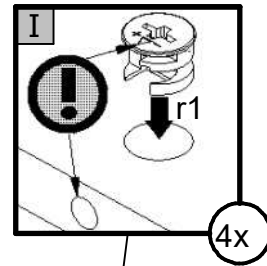
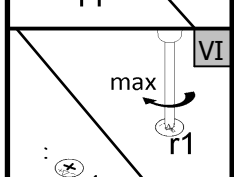
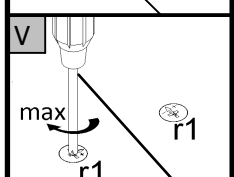
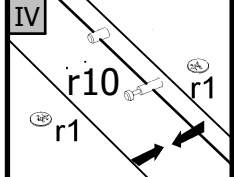
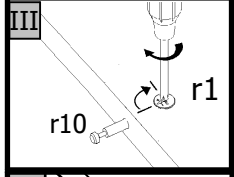
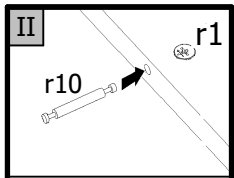
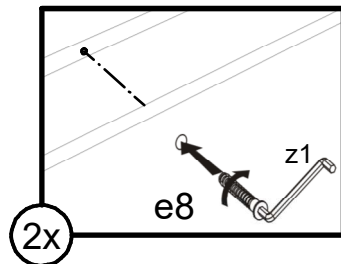
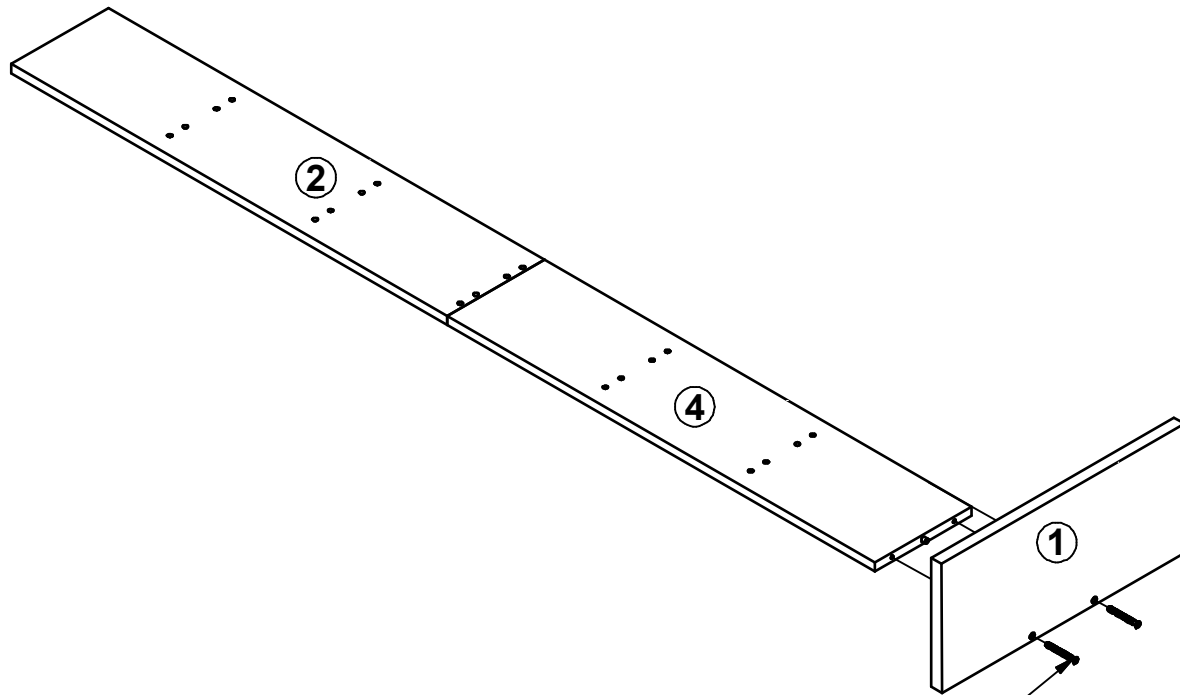

3

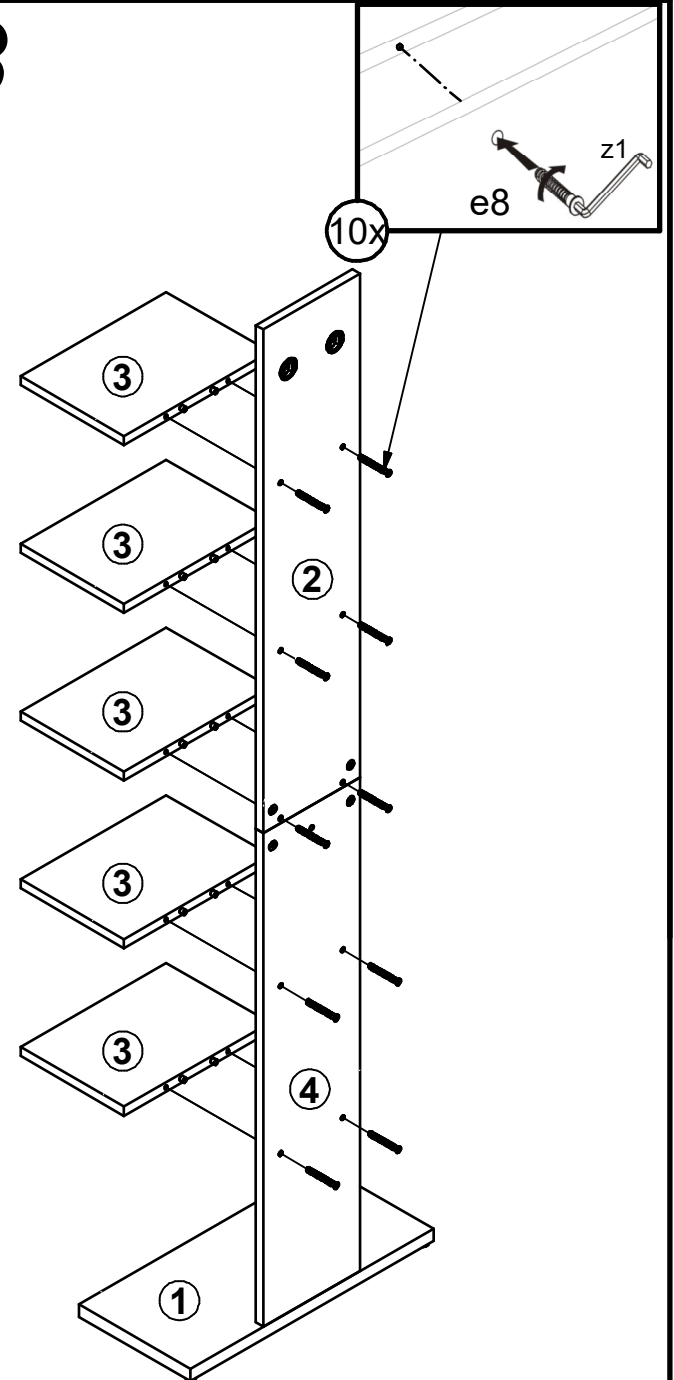

10x

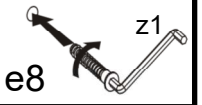

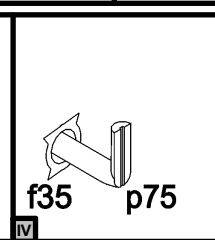
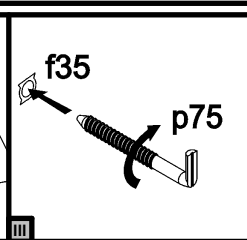
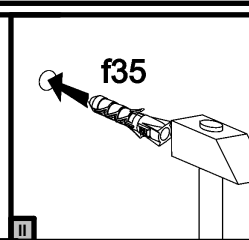
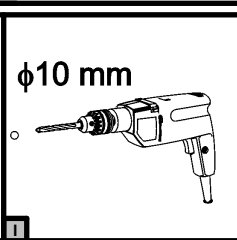
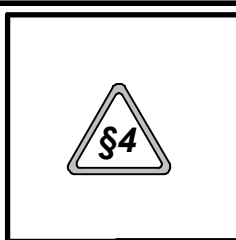
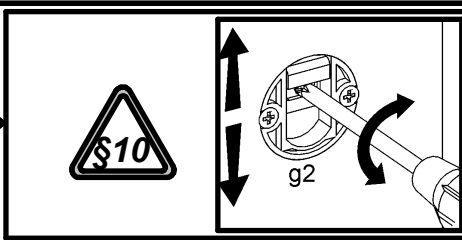
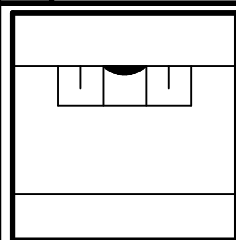

4

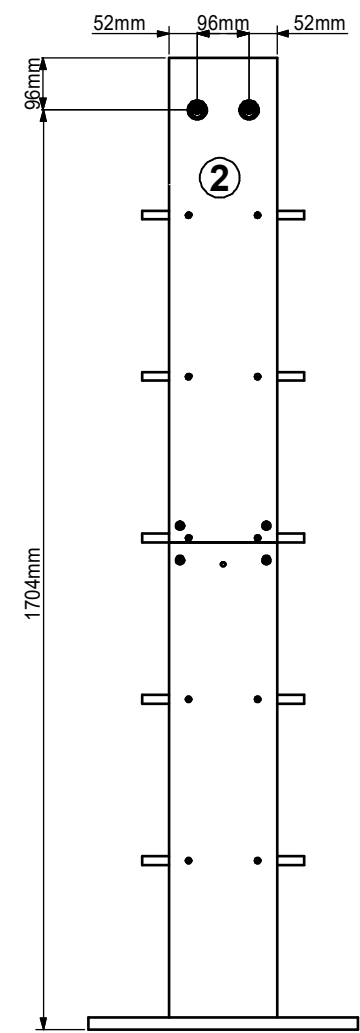
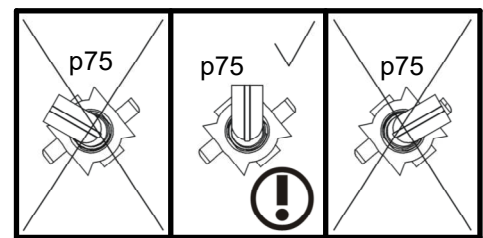
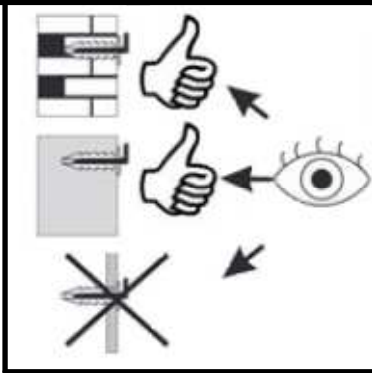
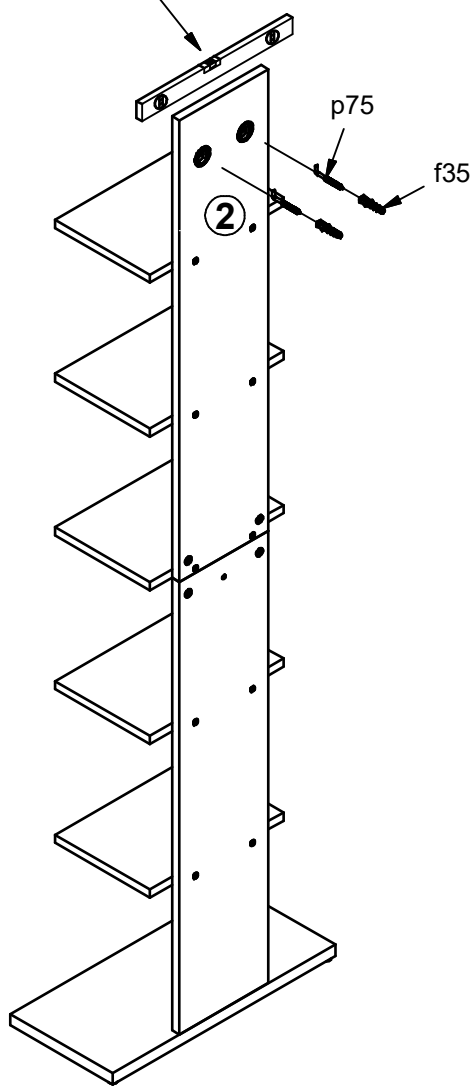

# 5

