

ELKE

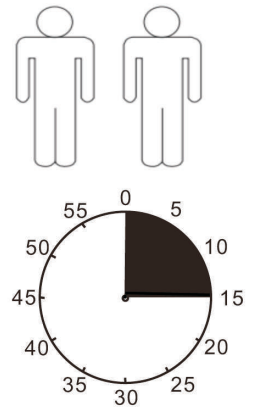

1

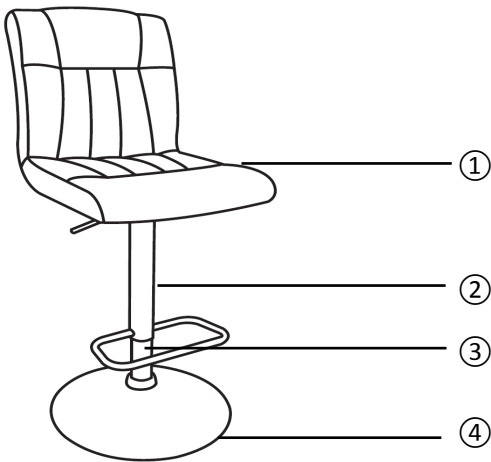
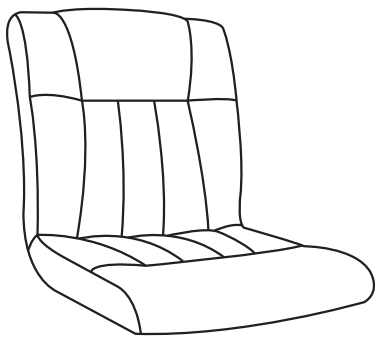

2

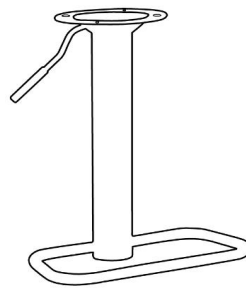

3



4

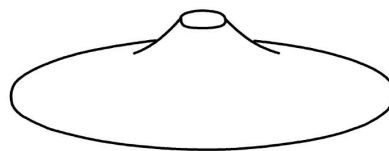

1	1x
2	1x
3	1x
4	1x

A



1X

B



4X

M6X18

C



1X

I.

1.

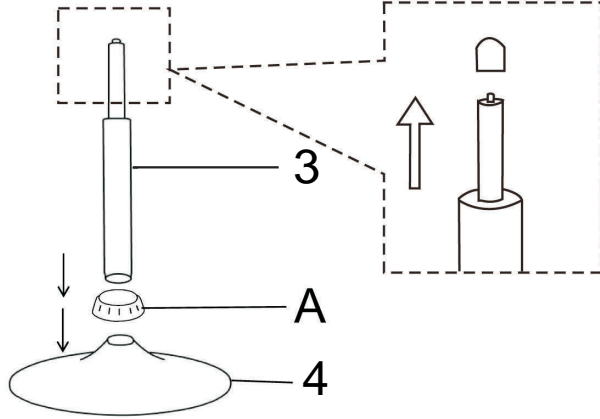

A

1X

2.

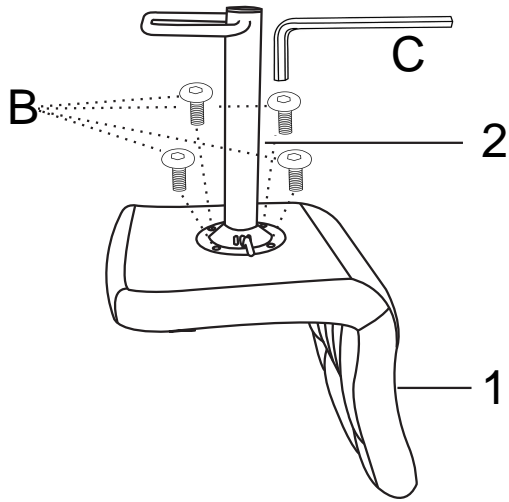

B

M6X18

4X

C

1X

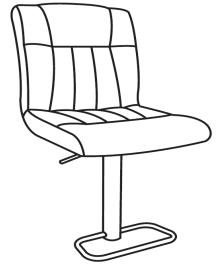

3.

