

Wandwinkel für Plissee-Faltstores Spannvariante 2

Artikelnummer: 591580

Inhalt : 4 Stck. Wandwinkel inkl. Abdeckkappe
8 Stck. Schrauben für Winkel 3,5 x 17 mm

Montage • Fitting • Montage • Montaggio • Монтаж

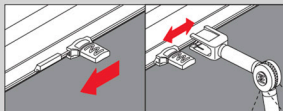
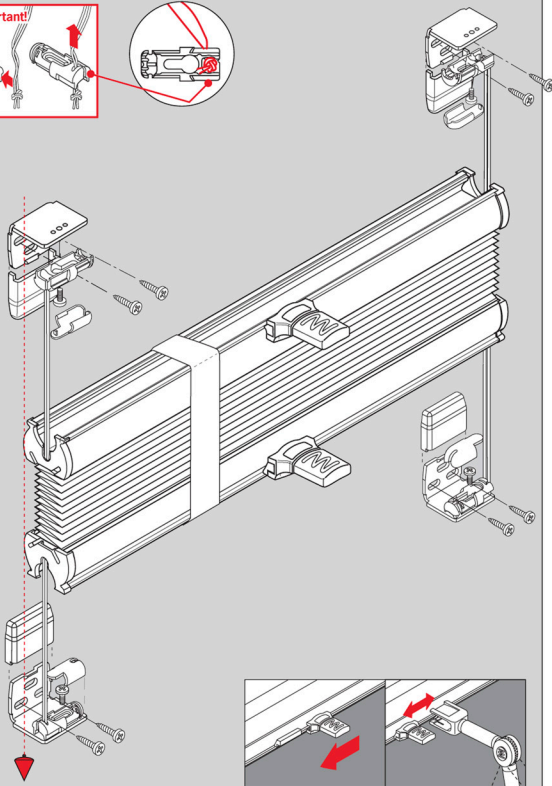
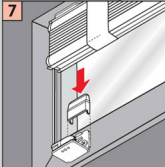
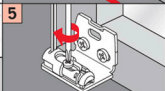
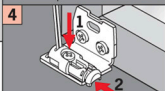
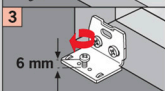
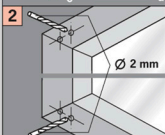
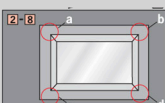
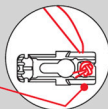

Demontage • Disassembly • Démontage • Демонтаж

