

**D** Montageanleitung

**FR** Notice de montage

**NL** Handleiding voor de montage

**CZ** Montážní návod

**HU** Szerelési útmutató

**TR** Montaj talimatı

**GB** Assembly instructions

**IT** Istruzioni di montaggio

**PL** Instrukcja montażu

**SK** Návod na montáž

**RO** Instrucțiuni de montaj

**RU** Инструкция по монтажу

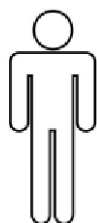

0  
1  
2  
3  
4  
5  
6  
7  
8  
9  
10  
11  
12  
13  
14  
15  
16  
17  
18  
19  
20

<b>Service • Assistent • Dienstverlening • Serwis</b> <b>Servis • Szerviz • Сервисная служба</b>		
Name • Nom • Nome • Naam • Nazwa • Jméno • Názov • Név • Denumire • Isim • Название		
Nr. • No. • N° • Номер • Č • Sz	9639 0959 9542 1957	
Typ • Type • Tip • Típus • Tipo Тип		

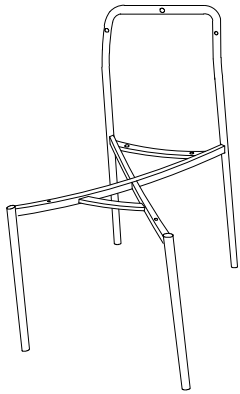

① 1X

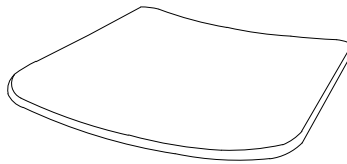

② 1X

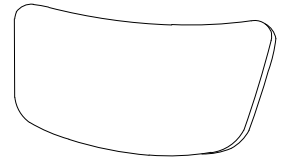

③ 1X

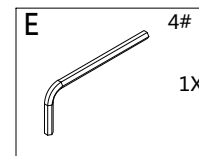
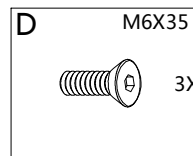
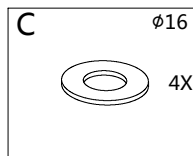
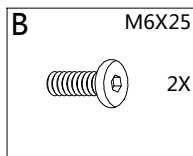
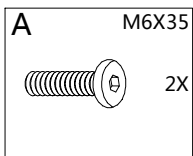

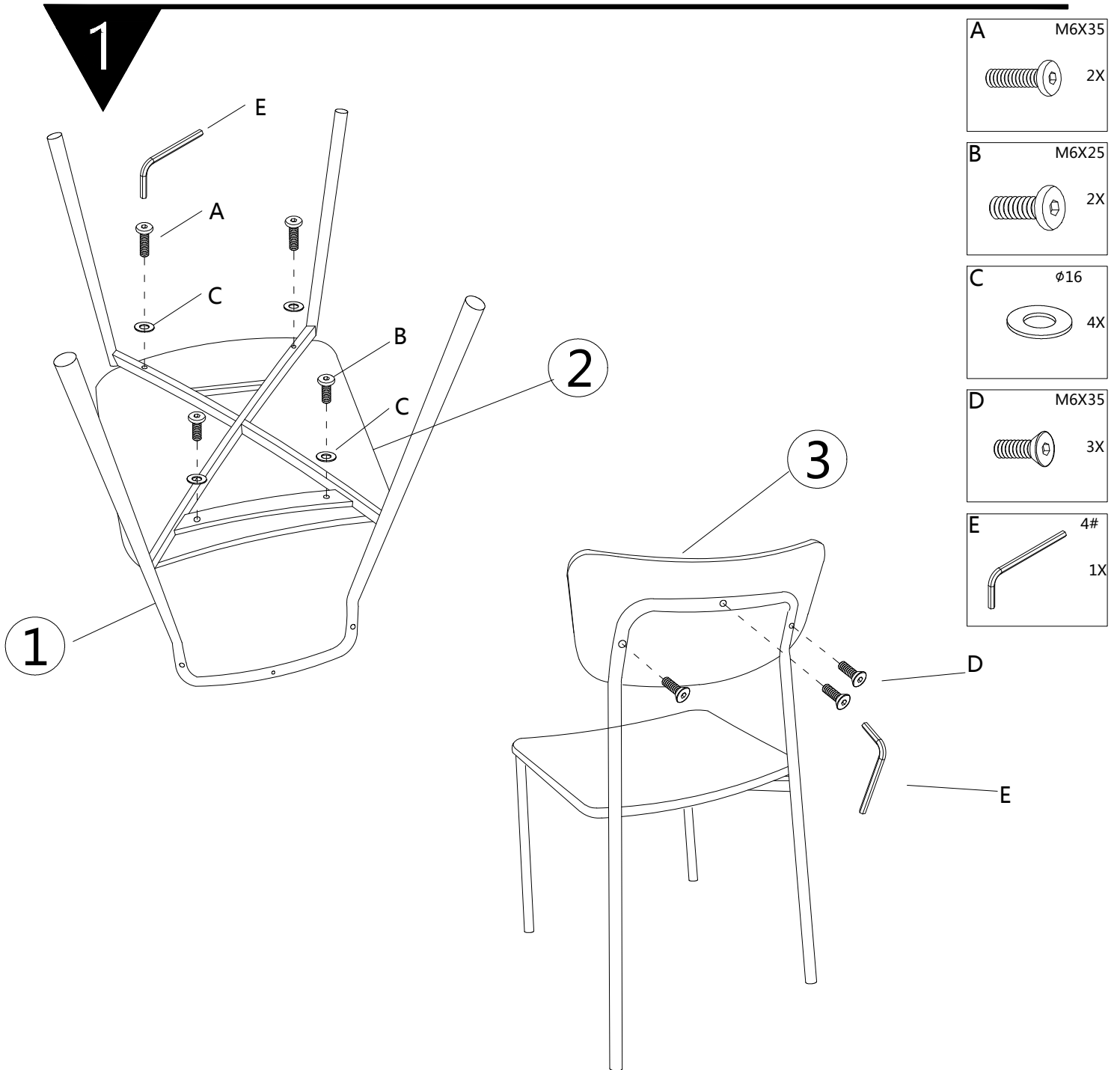
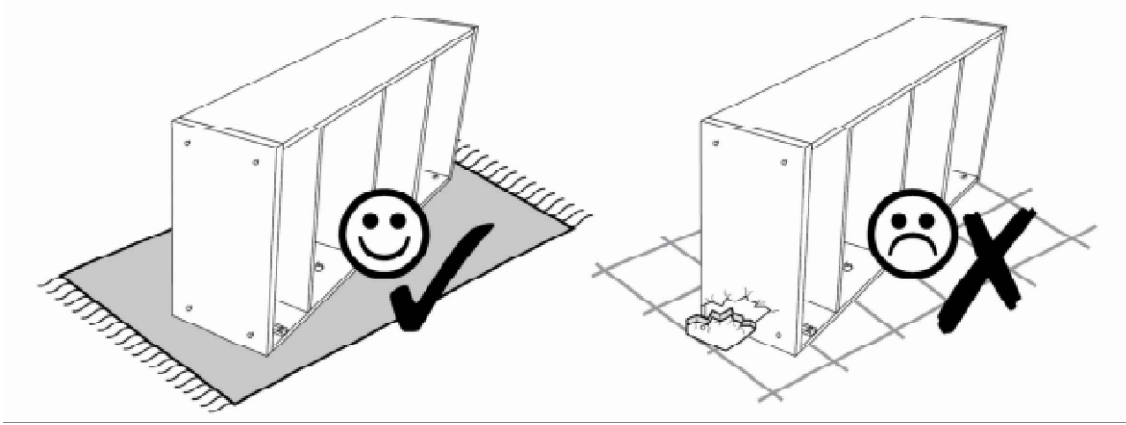

2

 Max  
120Kg

