

# KONIFERA

## Kalamos

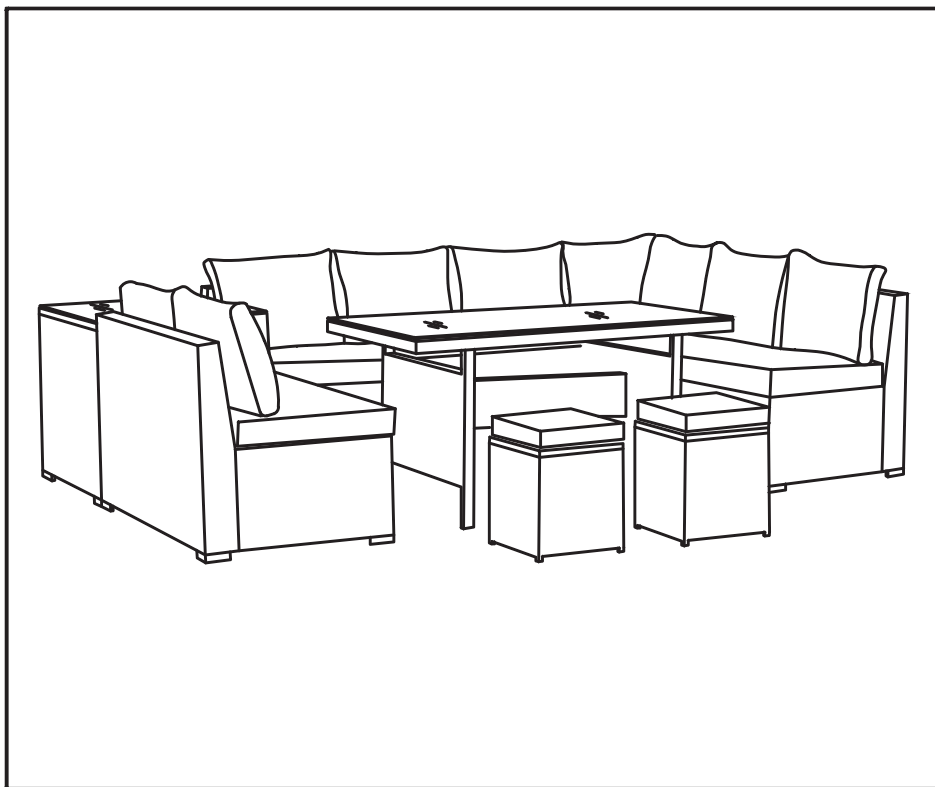

- |                               |                           |
|-------------------------------|---------------------------|
| Ⓓ Montageanleitung            | Ⓖ Assembly instructions   |
| Ⓕ Notice de montage           | Ⓘ Istruzioni di montaggio |
| Ⓝ Handleiding voor de montage | Ⓟ Instrukcja montażu      |
| Ⓒ Montážní návod              | Ⓢ Návod na montáž         |
| Ⓗ Szerelési utmutató          | Ⓡ Instrucțiuni de montaj  |
| Ⓡ Montaj talimatı             | Ⓡ Инструкция по монтажу   |

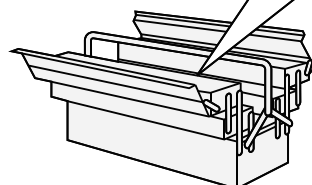
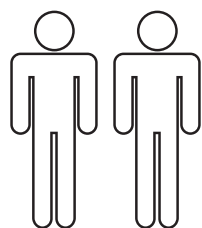

## DE

- Befolgen Sie stets die Anleitungen des Herstellers.
- Sorgen Sie dafür, dass Glasflächen genügend Abstand zu heißen oder sehr kalten Gegenständen haben.
- Stoßen Sie nicht mit harten Gegenständen an die Glasflächen oder -kanten.
- Setzen, stellen oder stützen Sie sich nie auf die Glasflächen.
- Der Artikel ist kein Kinderspielzeug! Lassen Sie Kinder auch nicht mit der Verpackung spielen. Sie könnten an der Folie ersticken oder sich an der Umverpackung verletzen.
- Achten Sie darauf, dass Kinder keine kleinen Teile, wie z. B. Muttern, Abdeckkappen oder Ähnliches in den Mund nehmen. Sie könnten sie verschlucken und daran ersticken.
- Um Verletzungen und Quetschungen zu vermeiden, verstellen, falten, öffnen oder schließen Sie den Artikel vorsichtig.
- Nur wenn alle Teile ordnungsgemäß arretiert sind, kann eine sichere Benutzung des Artikels gewährleistet werden.
- Ziehen Sie alle Schrauben sowie tragende Verbindungsteile nach ca. 5 Wochen nach, um eine dauerhafte Standsicherheit zu gewährleisten.

## GB

- Always follow the instructions of the manufacturer.
- Ensure that glass surfaces are situated at an adequate distance from hot or very cold objects.
- Do not bump glass surfaces or edges with hard objects.
- Never sit, stand, or lean on the glass surfaces.
- This product is not a toy! Do not allow children to play with the packaging. They could suffocate in the foil or injure themselves on the packaging.
- Ensure that children do not put any small parts such as nuts, caps, or the like in their mouth. They could swallow and choke on them.
- To avoid injury and crushing, adjust, fold, open or close the item carefully.
- Safe use of the item can only be guaranteed if all parts are properly locked in place.
- After approx. 5 weeks, tighten all screws and load-bearing connecting parts to ensure permanent stability.

## FR

- Suivez toujours les instructions du fabricant.
- Le remplacement des vérins pneumatiques ou les travaux effectués dessus ne pourront être réalisés que par du personnel spécialisé formé.
- Faites en sorte que les surfaces vitrées soient à distance suffisante d'objets chauds ou très froids.
- Ne frappez pas sur la surface ou le bord de la vitre avec un objet dur.
- Ne vous asseyez pas, ne montez pas ou ne vous appuyez pas sur les surfaces vitrées.
- L'article n'est pas un jouet ! Ne laissez pas non plus les enfants jouer avec la feuille d'emballage en plastique. Ils peuvent s'asphyxier avec le film plastique ou se blesser avec les moyens d'emballage.
- Veillez à ce que les enfants ne mettent aucune petite pièce, comme p. ex. des écrous, des capuchons ou similaires, dans la bouche. Ils peuvent les avaler et s'étouffer.
- Une utilisation sûre de l'article ne peut être garantie que si toutes les pièces sont correctement bloquées.
- Resserrez toutes les vis ainsi que les pièces de fixation au bout d'environ 5 semaines pour garantir une sécurité de fixation durable.

## IT

- Seguire sempre le istruzioni del produttore.
- La sostituzione dei pistoncini o eventuali interventi sui pistoncini possono essere eseguiti solo da personale qualificato addestrato.
- Assicursi che le superfici vetrate si trovino a distanza sufficiente da oggetti molto caldi o molto freddi.
- Evitare di colpire con oggetti contundenti le superfici o gli spigoli di vetro.
- Non sedersi, appoggiarsi o sorreggersi sulle superfici vetrate.
- L'articolo non è un giocattolo! Non permettere ai bambini neanche di giocare con l'imballaggio. Rischio di soffocamento per via della pellicola o di lesioni per via dell'imballaggio esterno.
- Assicursi che i bambini non portino alla bocca le parti piccole, ad es. dadi, coperchietti e simili. Potrebbero ingerirle e soffocare.

- L'uso sicuro dell'articolo può essere garantito solo se tutte le parti sono correttamente bloccate in posizione.
- Ristringere tutte le viti e giunture dopo ca. 5 settimane, al fine di garantire una durevole solidità.

## NL

- Volg steeds de instructies van de fabrikant.
- De vervanging van de gasdrukveer resp. het werk eraan mag alleen gebeuren door geschoolde vaklui.
- Zorg ervoor dat de glazen oppervlakken op voldoende afstand staan van hete of zeer koude voorwerpen.
- Stoot niet met harde voorwerpen tegen de glazen oppervlakken of randen.
- Ga niet zitten, staan op of leunen tegen de glazen oppervlakken.
- Het artikel is geen speelgoed voor kinderen! Zorg ervoor dat kinderen ook niet met de verpakking spelen. Ze kunnen stikken door de folie of zich verwonden aan de verpakking.
- Zorg ervoor dat kinderen geen kleine stukken, zoals moeren, afdekkapjes of dergelijke in de mond nemen. Ze kunnen ze inslikken en daardoor stikken.
- Alleen als alle onderdelen correct zijn vergrendeld, kan een veilig gebruik van het artikel worden gegarandeerd.
- Draai alle schroeven en ook dragende verbindingstukken na ca. 5 weken nog eens vast, zodat een continue stabiliteit wordt gegarandeerd.

## PL

- Zawsze należy przestrzegać instrukcji producenta.
- Wymiana lub inne prace wykonywane przy amortyzatorach gazowych mogą być przeprowadzane tylko przez przeszkolony personel.
- Powierzchnie szklane powinny znajdować się w znacznej odległości od przedmiotów za gorących lub bardzo zimnych.
- Nie uderzać twardymi przedmiotami w szklane powierzchnie i krawędzie.
- Na szklanych powierzchniach nie wolno siadać, stawać i opierać się.

- Produkt nie służy do zabawy! Dzieci nie powinny bawić się opakowaniem produktu, gdyż mogą się udusić się folią lub skaleczyć opakowaniem.
- Należy dopilnować, aby dzieci nie bawiły się lub też brały do ust żadnych drobnych części mebla, takich jak np. nakrętki, zatyczki itp. Mogłyby je połknąć i udusić się nimi.
- Bezpieczne użytkowanie przedmiotu można zagwarantować tylko wtedy, gdy wszystkie części są prawidłowo zablokowane.
- Prosimy po ok. 5 tygodniach dokręcić wszystkie śruby i elementy łączeniowe. Zagwarantuje to Państwu trwałość i stabilność połączeń.

## CZ

- Vždy se řiďte pokyny výrobce.
- Výměnu plynových pružin, popř. práci na nich smí provádět jen zaškolení specialisté.
- Postarejte se o to, aby se skleněné plochy nacházely v dostatečné vzdálenosti od horkých nebo velmi studených předmětů.
- Nenarážejte tvrdými předměty do skleněných ploch nebo hran.
- Na skleněné plochy si nikdy nesedejte, nestoupejte na ně ani se o ně neopírejte.
- Výrobek není hračkou pro děti! Nenechávejte děti ani hrát si s obalem. Mohly by se udusit fólií nebo se poranit o přebal.
- Dbejte na to, aby děti nedávaly do úst žádné drobné díly jako např. matice, krytky a podobně. Mohly by je spolknout a udusit se.
- Bezpečné používání výrobku může být zaručeno jen tehdy, pokud jsou všechny jeho části řádně zajištěny.
- Dotáhněte všechny šrouby a nosné spojovací díly přibližně po 5 týdnech, aby se zaručila trvalá stabilita.

## SK

- Vždy dodržiavajte pokyny výrobcu.
- Výmenu pneumatickej pružiny, príp. práce na nej, smie vykonať len vyškolený odborný personál.
- Postarajte sa, aby sklené plochy boli v dostatočnej vzdialenosti od horúcich alebo veľmi studených predmetov.

- Nendarazte s tvrdými predmetmi na sklené plochy alebo hrany.
- Nikdy si nesadnite, nepostavte sa alebo sa neoprite na sklené plochy.
- Tento výrobok nie je žiadnou hračkou pre deti! Nedovoľte deťom, aby sa hrali s obalovou fóliou. Mohli by sa s fóliou zadusiť alebo sa na vrchnom obale poraniť.
- Dbajte, aby si deti nemohli dať do úst drobné diely, ako napr. matice, krytky alebo podobne. Mohli by ich prehltnúť a zadusiť sa.
- Bezpečné používanie výrobku je možné zaručiť iba vtedy, ak sú všetky časti správne zaaretované.
- Po cca 5 týždňoch dotiahnite skrutky, aby bola zaručená ich trvalá stabilita.

## HU

- Kövesse a gyártó utasításait.
- A gázrúgót kizárólag képzett szakember cserélheti és javíthatja.
- Biztosítson megfelelő távolságot az üvegfelületek és a túl meleg vagy túl hideg tárgyak között.
- Védje az üvegfelületeket és azok éleit az ütődésektől.
- Soha ne üljön, álljon, támaszkodjon az üvegfelületre.
- A termék nem gyermekek számára készült játékszer! Ne hagyja a gyermekeket a csomagolófóliával játszani. A fóliába tekeredve megfulladhatnak vagy sérülést szenvedhetnek.
- Gondoskodjon arról, hogy a gyerekek ne vehessék a szájukba a kis alkatrészeket, pl. az anyákat, a fedőkupakokat stb. Ezeket lenyelve megfulladhatnak.
- A termék biztonságos használata csak az összes alkatrész szabályszerű rögzítése esetén szavatolható.
- Húzza utána – kb. 5 hét múlva – az összes csavart és a teherhordó összekötő-alkatrészeket a biztonság érdekében.

## RO

- Urmați instrucțiunile producătorului.
- Înlucuirea arcurilor comprimate cu gaz sub presiune, respectiv toate lucrările aferente, se efectuează numai de către personal de specialitate instruit.

- Asigurați suprafețelor din sticlă o distanță suficientă față de obiectele prea fierbinți sau foarte reci.
- Evitați impactul suprafețelor sau a marginilor din sticlă cu obiecte dure.
- Nu vă așezați și nu vă sprijiniți niciodată pe suprafețele din sticlă.
- Produsul nu constituie un obiect de joacă pentru copii! Nu lăsați copiii să se joace cu folia ambalajului. Există pericolul de asfixiere cu folia sau de rănire cu ambalajul.
- Supravegheați copiii pentru că pot să introducă în gură piesele mici, cum ar fi de exemplu piulițe, capace sau altele similare. Ei pot să le înghită și se pot asfixia.
- Doar dacă toate piesele componente sunt blocate în mod corespunzător, se poate garanta utilizarea în siguranță a articolului.
- Pentru a asigura o stabilitate de durată, strângeți după cca. 5 săptămâni toate șuruburile, precum și toate elementele portante de legătură.

## TR

- Daima üreticinin talimatlarına uyunuz.
- Gazlı basınç yayının değiştirilmesi veya onunla ilgili çalışmalar yalnızca bu konuda eğitim almış uzman personel tarafından yapılmalıdır.
- Cam yüzeylerin çok soğuk veya çok sıcak nesnelere yeteri kadar uzakta olmasına dikkat ediniz.
- Cam yüzeylere veya cam kenarlara sert cisimlerle temas etmemeye dikkat ediniz.
- Asla cam yüzeylerinin üzerine çıkmayınız, üzerine oturmayınız ve onlardan destek almayınız.
- Bu ürün bir çocuk oyuncakı değildir! Çocukların ürün ambalajlarıyla oynamalarına asla müsaade etmeyiniz. Çocuklar, folyo nedeniyle boğulabilir veya ambalaj nedeniyle yaralanabilirler.
- Çocukların somun, muhafaza kapakçıkları ve benzeri küçük parçaları ağızlarına almamalarına dikkat ediniz. Bunları yutabilirler ve boğulabilirler.
- Ancak tüm parçalar usulüne uygun bir şekilde yerine oturduğunda ürünün güvenli bir şekilde kullanımı garanti edilebilir.
- Tüm vida ve taşıyıcı bağlantı parçalarını kalıcı bir duruş güvenliğini sağlamak için yaklaşık 5 hafta sonra tekrar sıkınız.

## RU

- Строго соблюдайте инструкции производителя.
- Замену газовой пружины и работы над ней должен осуществлять квалифицированный персонал, прошедший соответствующий инструктаж.
- Стеклянные поверхности должны находиться на достаточном расстоянии от горячих или слишком холодных предметов.
- Не допускайте ударов твердыми предметами по стеклянным поверхностям или по их краям.
- Никогда не садитесь, не становитесь и не опирайтесь на стеклянные поверхности.
- Не допускается игра детей с изделием! Не разрешайте детям играть с упаковочным материалом. Дети могут задохнуться в упаковочной пленке или пораниться упаковочным материалом.
- Следите, чтобы мелкие детали, например гайки, крышки и т. п., не попали в рот ребенка. Дети могут их проглотить и задохнуться.
- Использование изделия может быть безопасным только в том случае, если все его элементы зафиксированы надлежащим образом.
- Подкрутите все болты, а также несущие соединительные детали прибл. через 5 недель для обеспечения устойчивости в течение длительного времени.



**D: WICHTIG, FÜR SPÄTERE BEZUGNAHME  
DIESES DOKUMENT AUFBEWAHREN!  
SORGFÄLTIG LESEN!**

Dieses Außenmöbel ist nur zur Verwendung im privaten Wohnbereich vorgesehen.

**GB: IMPORTANT, HOLD ON TO THIS DOCUMENT  
FOR LATER REFERENCE! READ CAREFULLY!**

This outdoor furniture is only intended for use in private residential areas.

**FR: IMPORTANT, CONSERVER CE DOCUMENT  
POUR VOUS Y RÉFÉRER ULTÉRIEUREMENT! LE  
LIRE ATTENTIVEMENT!**

Ce meuble d'extérieur n'est prévu que pour une utilisation dans le domaine privé.

**IT: IMPORTANTE, CONSERVARE LE PRESENTI  
ISTRUZIONI PER OGNI ULTERIORE  
CONSULTAZIONE! LEGGERE CON ATTENZIONE!**

Il presente mobile da esterno è previsto solo per l'uso in ambito domestico.

**NL: BELANGRIJK, BEWAAR DIT DOCUMENT ALS  
REFERENTIE IN DE TOEKOMST!**

ZORGVULDIG LEZEN! Dit buitenmeubel is alleen bedoeld voor het gebruik in  
privéwoningen.

**PL: WAŻNE, DOKUMENT PRZECHOWAĆ NA  
PRZYSZŁOŚĆ JAKO MATERIAŁ REFERENCYJNY!  
DOKŁADNIE PRZECZYTAĆ!**

Ten mebel zewnętrzny jest przewidziany jedynie do użytku w prywatnych strefach  
mieszkalnych.

**RO: IMPORTANT! PĂSTRAȚI ACEST DOCUMENT  
PENTRU CONSULTAREA ULTERIOARĂ! CITITI CU  
ATENTIE!**

Acest mobilier de exterior este destinat doar utilizării în zonele de locuit private.

**RU: ВАЖНО СОХРАНИТЬ ЭТОТ ДОКУМЕНТ ДЛЯ ИСПОЛЬЗОВАНИЯ В ДАЛЬНЕЙШЕМ!  
ВНИМАТЕЛЬНО ОЗНАКОМЬТЕСЬ С НИМ!**

Этот предмет уличной мебели предназначен только для использования в частных жилых зонах.

**SK: DÔLEŽITÉ, USCHOVAJTE SI TENTO DOKUMENT PRE BUDÚCE POUŽITIE! ČÍTAJTE POZORNE!**

Tento vonkajší nábytok je určený len na použitie v súkromnom obytnom priestore.

**CZ: DŮLEŽITÉ! TENTO DOKUMENT SI USCHOVEJTE PRO POZDĚJŠÍ POUŽITÍ. ČTĚTE POZORNĚ!**

Tento venkovní nábytek je určený pouze k použití v soukromém obytném prostoru.

**HU: FONTOS – KÉSŐBBI FELHASZNÁLÁSRA ŐRIZZE MEG EZT A DOKUMENTUMOT!  
GONDOSAN OLVASSA EL!**

Ez a kültéri bútor csak magán lakóterületen történő használatra szolgál.

**TR: ÖNEMLİ, DAHA SONRA FAYDALANMAK İÇİN BU DOKÜMANI SAKLAYIN! DİKKATLİCE OKUYUN!**

Bu dış mekan mobilyası sadece özel oturma alanında kullanılması için tasarlanmıştır.

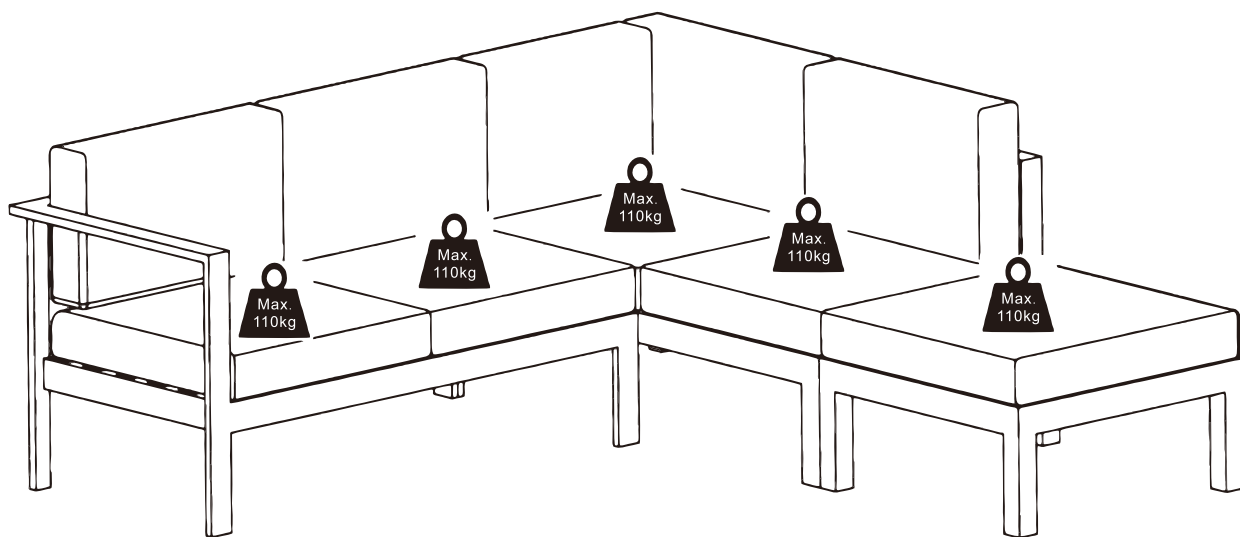

0  
10  
20  
30  
40  
50  
60  
70  
80  
90  
100  
110  
120  
130  
140  
150  
160  
170  
180  
190  
200

**Service • Assistenza • Dienstverlening • Serwis Servis • Szerviz •  
Сервисная служба**

Name • Nom • Nome • Naam • Nazwa • Jméno • Názov • Név • Denumire • İsim • Название	Kalamos
Nr. • No. • N° • Номер • Č • Sz	63798707,26338363
Typ • Type • Tip • Típus • Тиро • Тип	
	

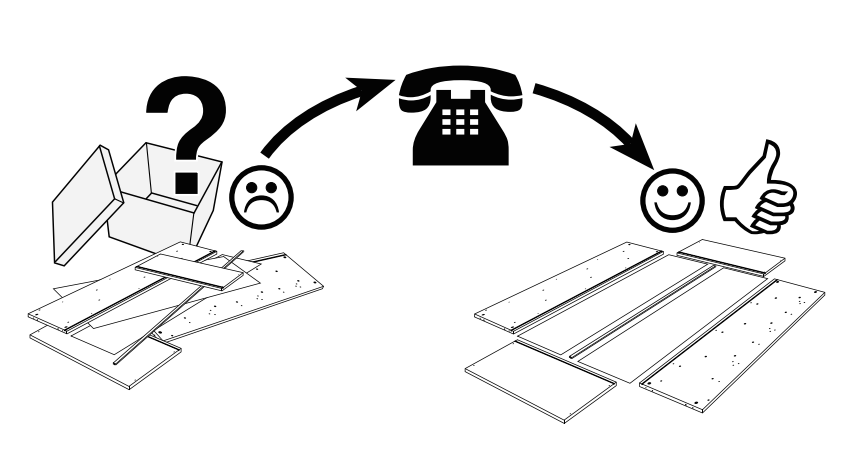
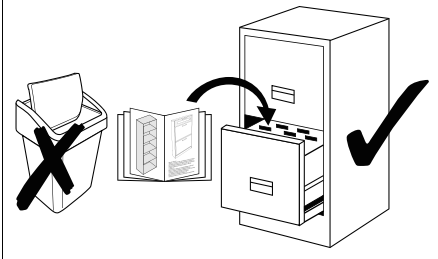

**AproductZ GmbH**  
Werner-Otto-Straße 1-7, 22179 Hamburg, Germany



**1**

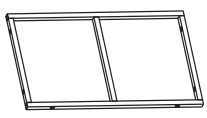

1x

**2**

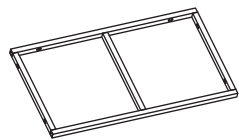

1x

**3**

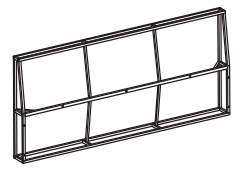

1x

**4**

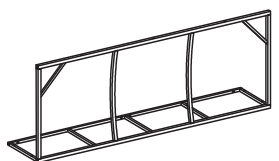

1x

**5**



1x

**6**

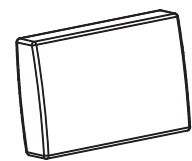

3x

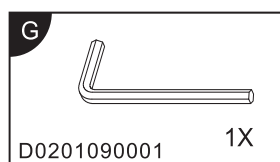
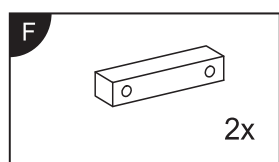
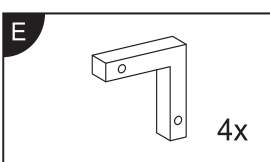
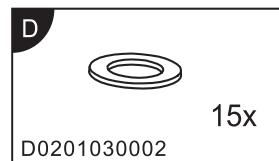
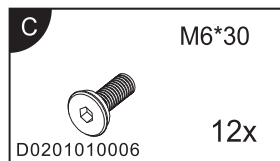
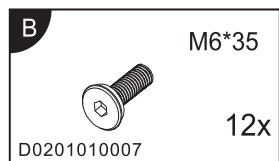
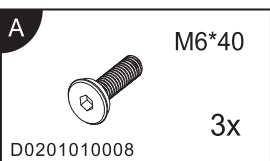

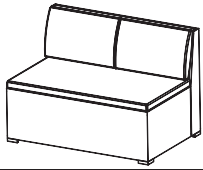

1

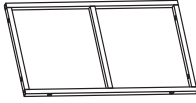

1x

2

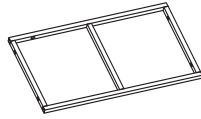

1x

7

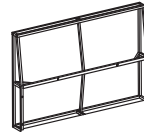

1x

8

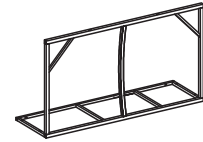

1x

9



1x

6

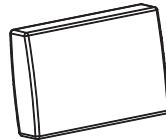

2x

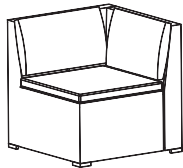
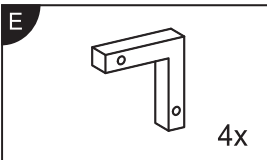
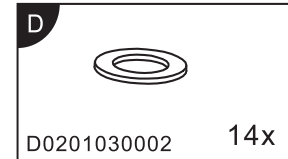
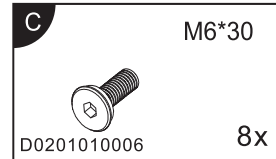
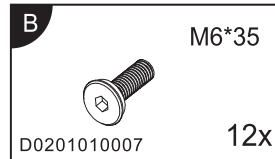
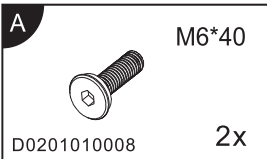

1

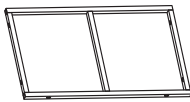

1x

10



1x

11



1x

12

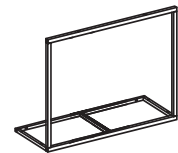

1x

13

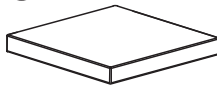

1x

6

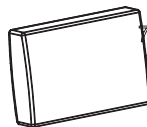

1x

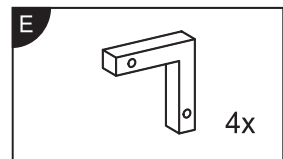
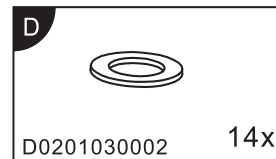
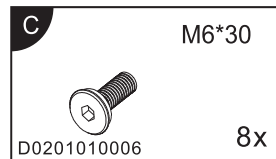
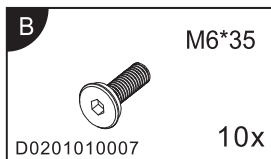
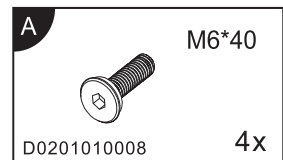

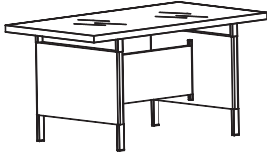

14



1x

15



1x

16

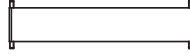

1x

17

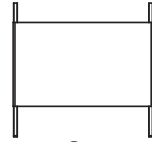

2x

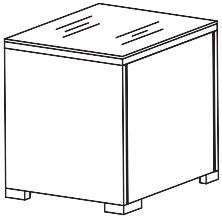
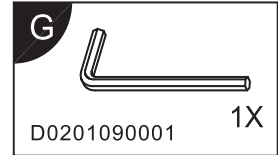
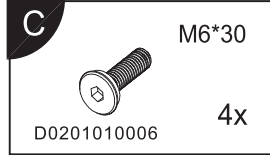
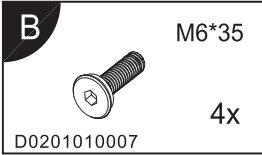

18

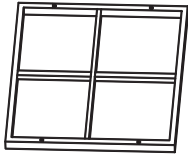

1x

19

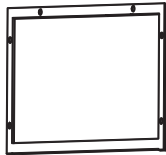

2x

20

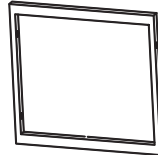

2x

21

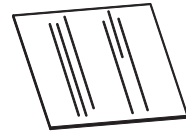

1x

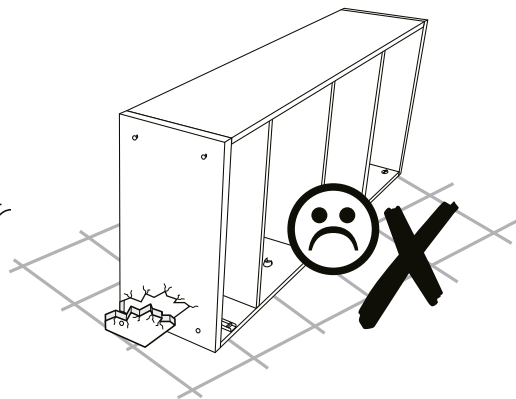
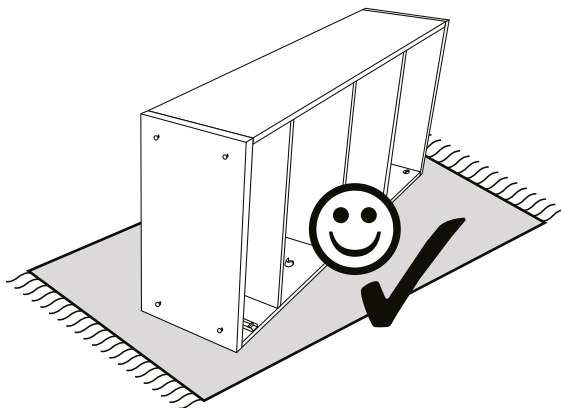
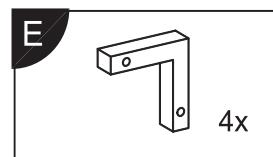
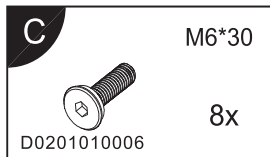
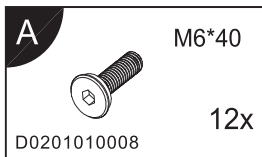

1

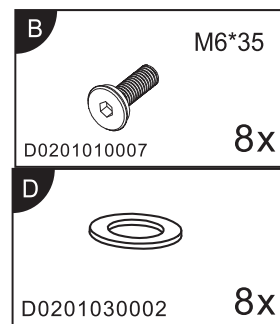
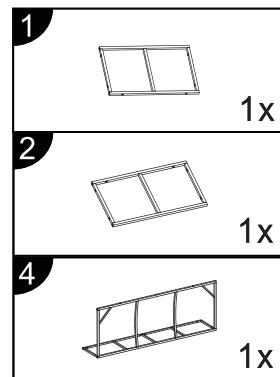
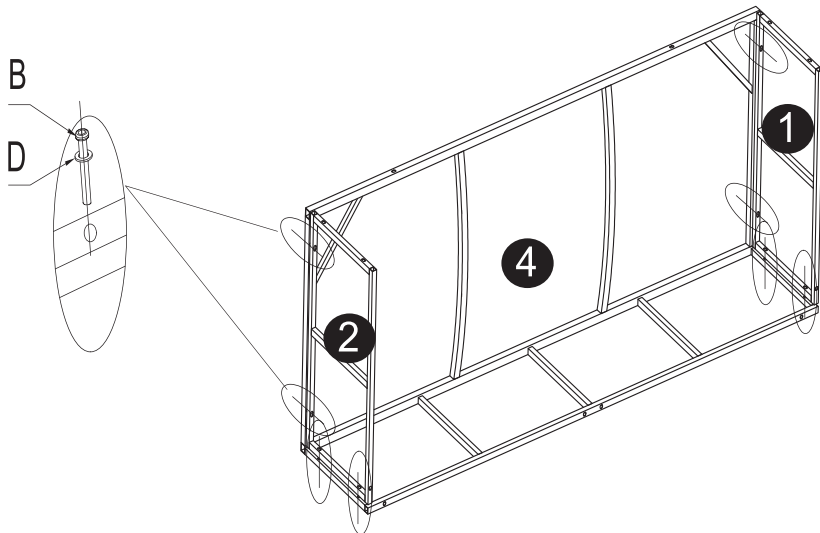
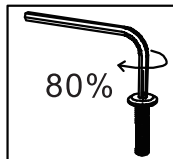

2

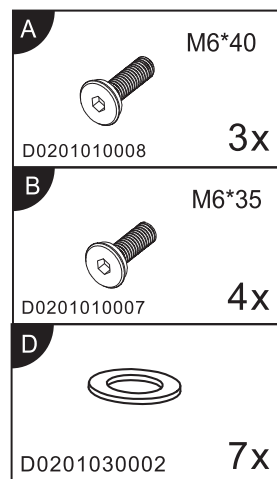
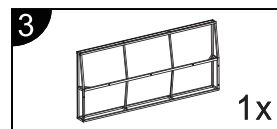
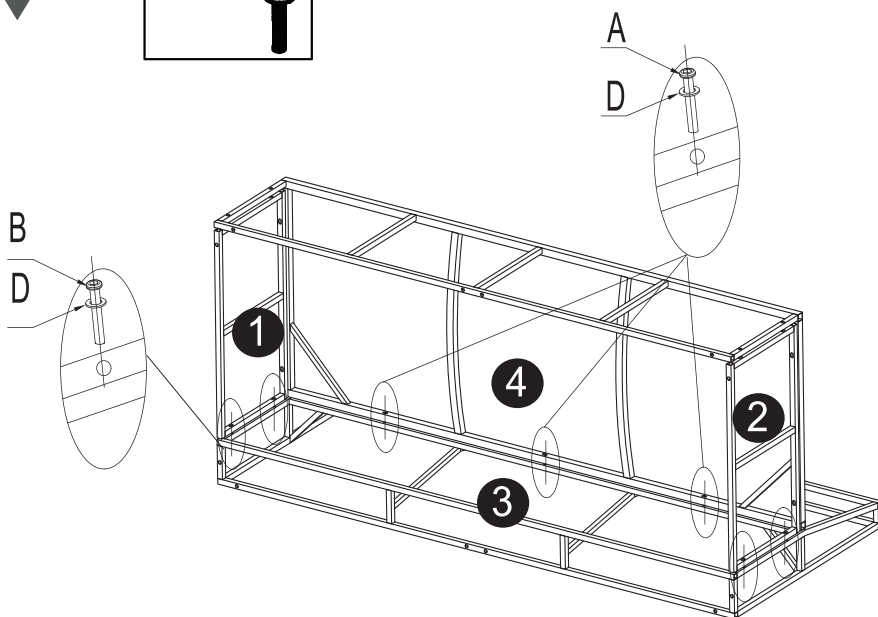
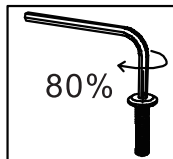

3

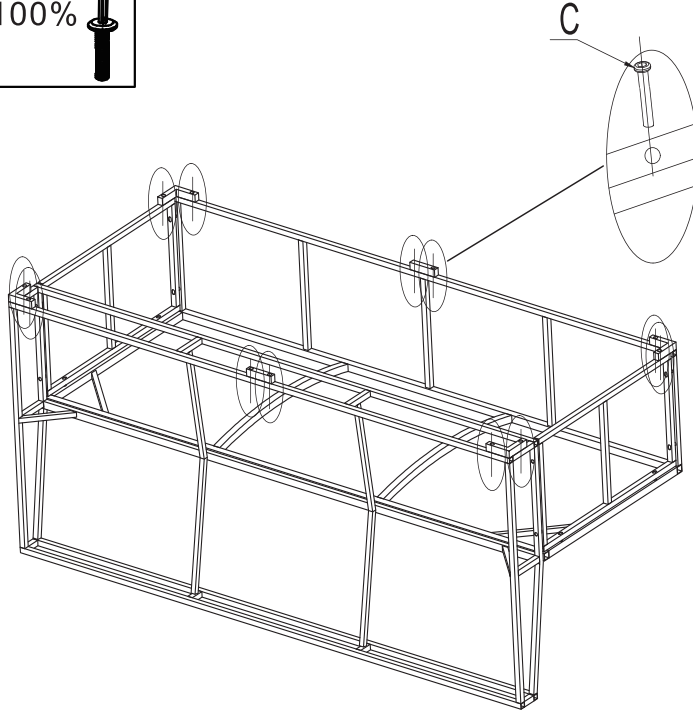
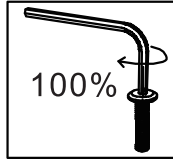

<b>E</b>		4x
<b>F</b>		2x
<b>C</b>		M6*30 12x D0201010006

4

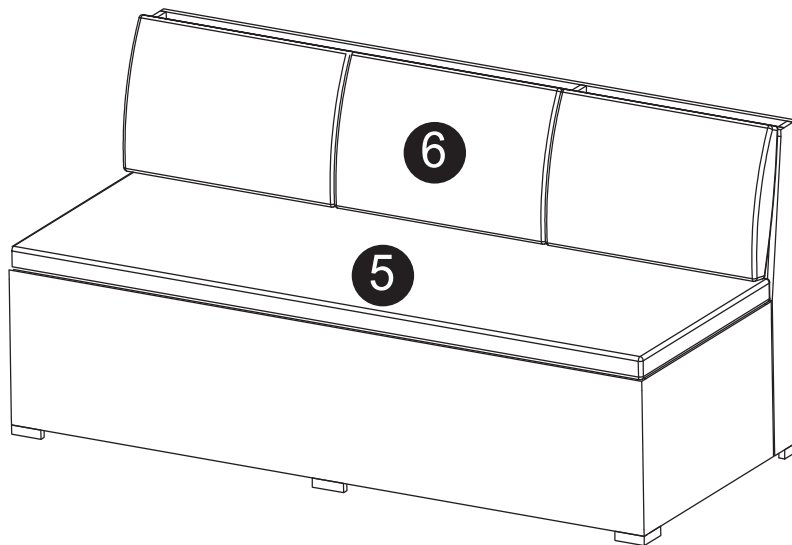

<b>5</b>		1x
<b>6</b>		3x

5

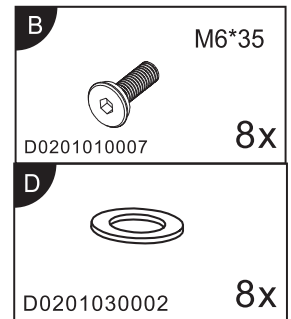
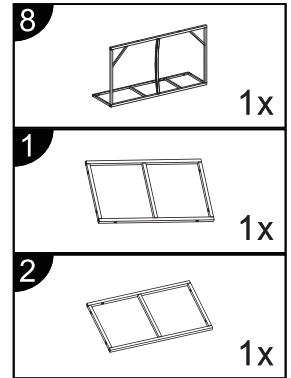
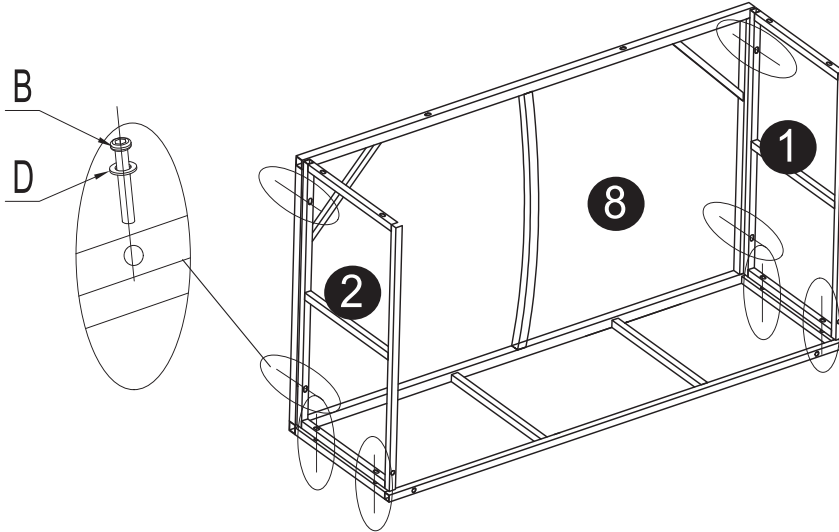
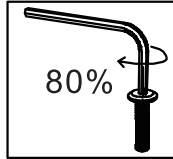

6

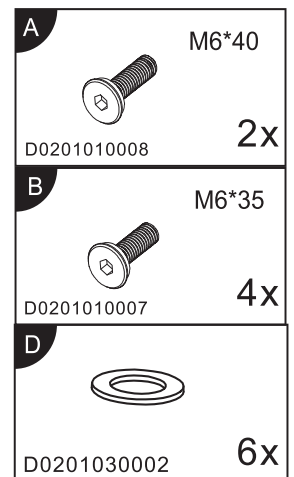
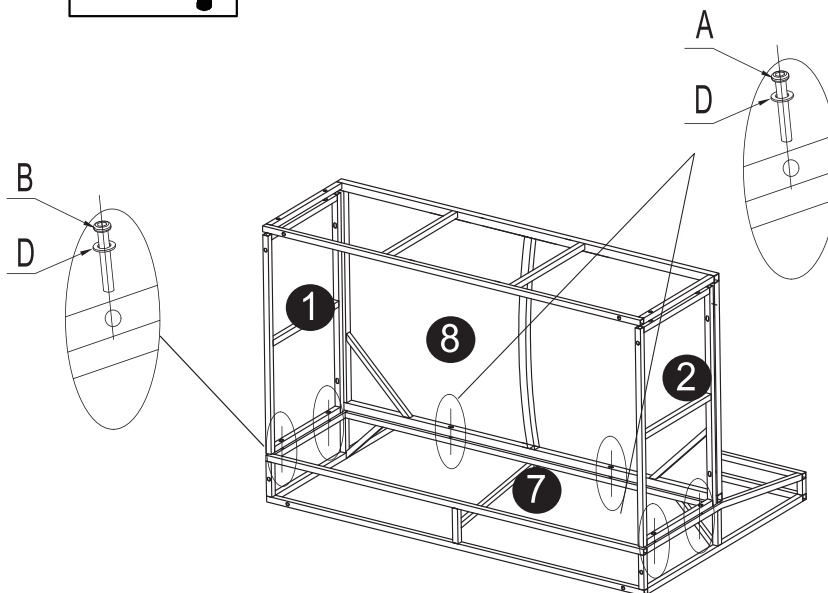
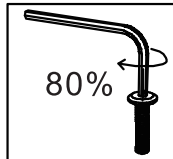



7

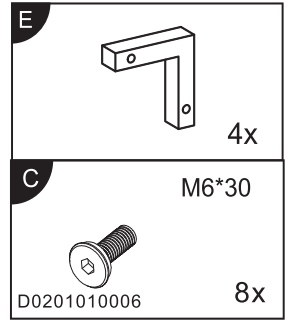
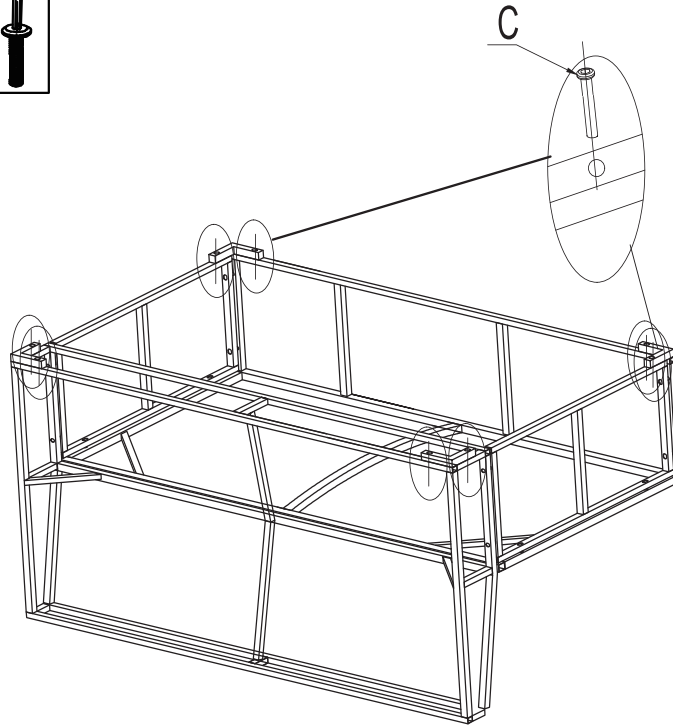
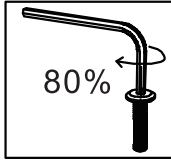

8

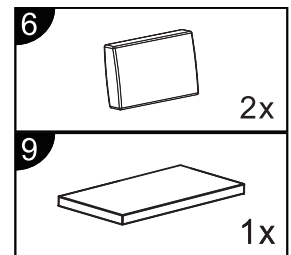
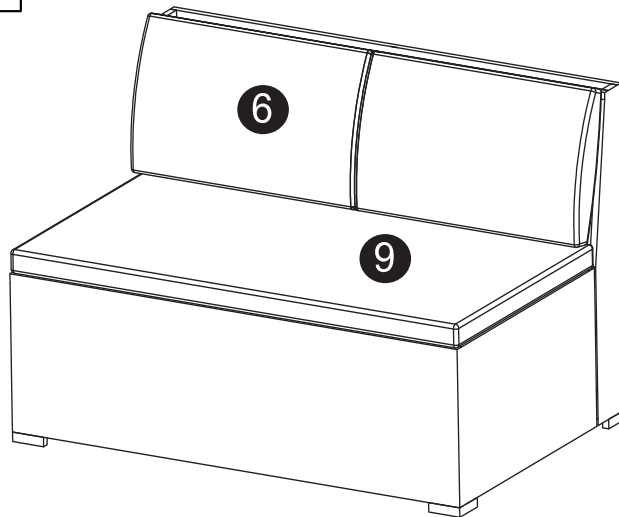
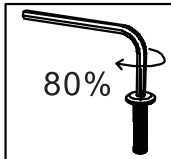

9

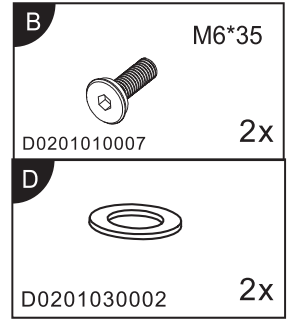
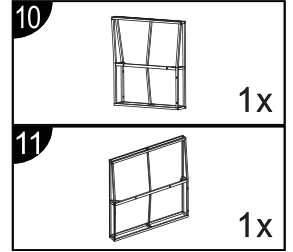
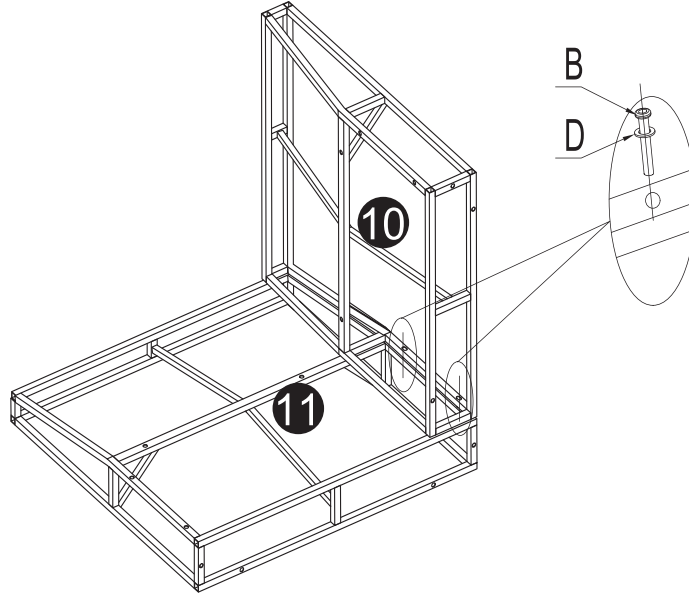
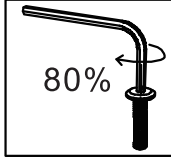

10

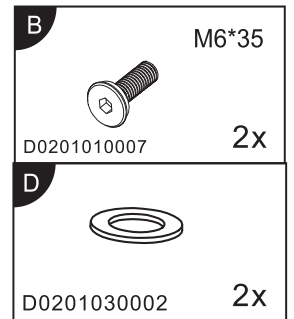
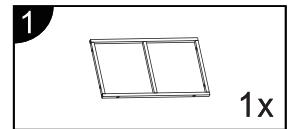
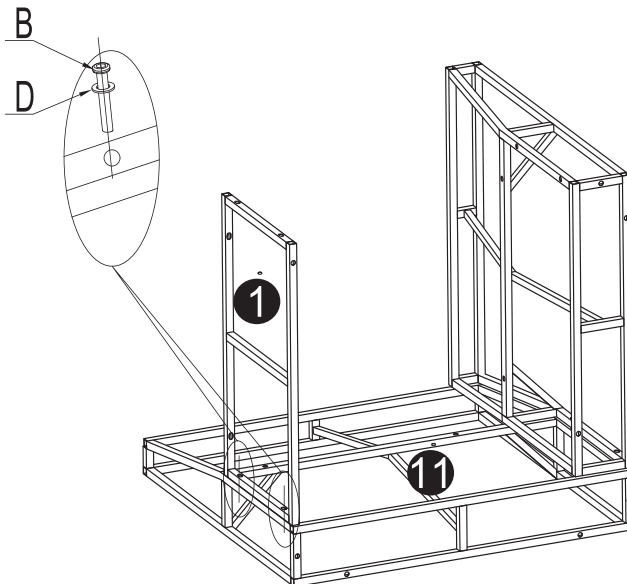
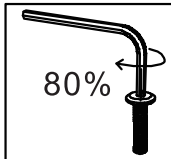

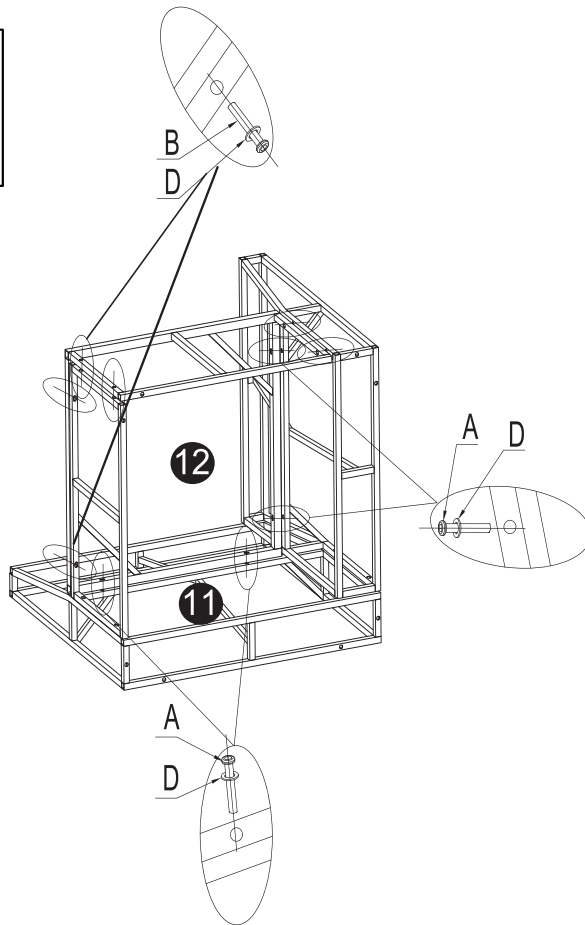
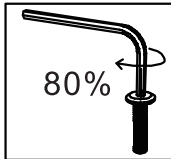

11





12

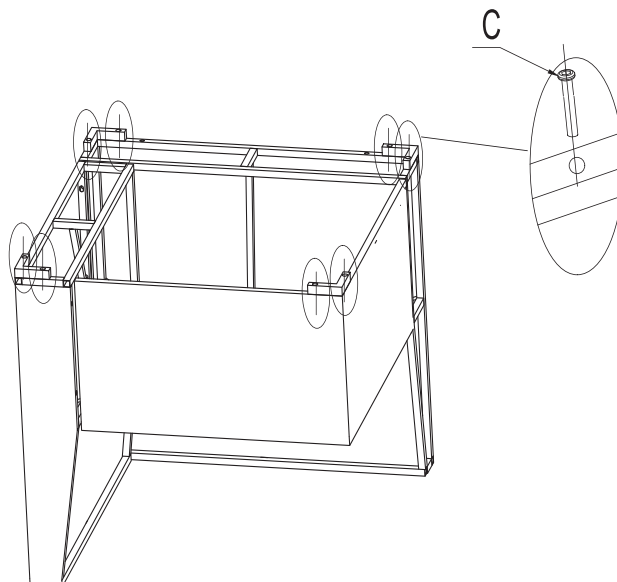
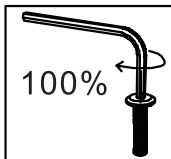

<b>A</b>	M6*40
	4x
D0201010008	
<b>B</b>	M6*35
	6x
D0201010007	
<b>D</b>	
	10x
D0201030002	

12

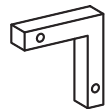

<b>E</b>	
	4x
<b>C</b>	M6*30
	8x
D0201010006	

13

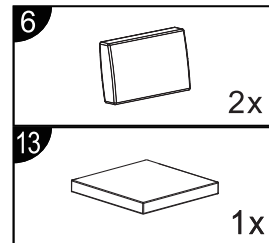
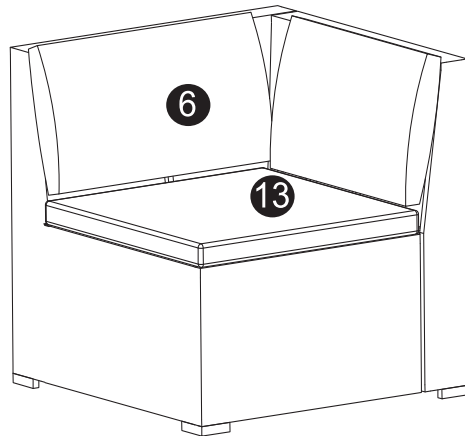

14

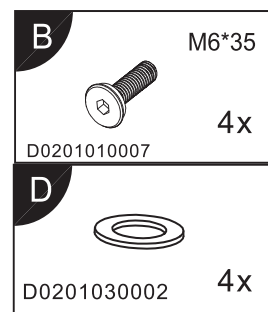
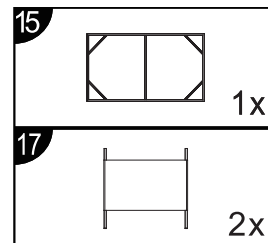
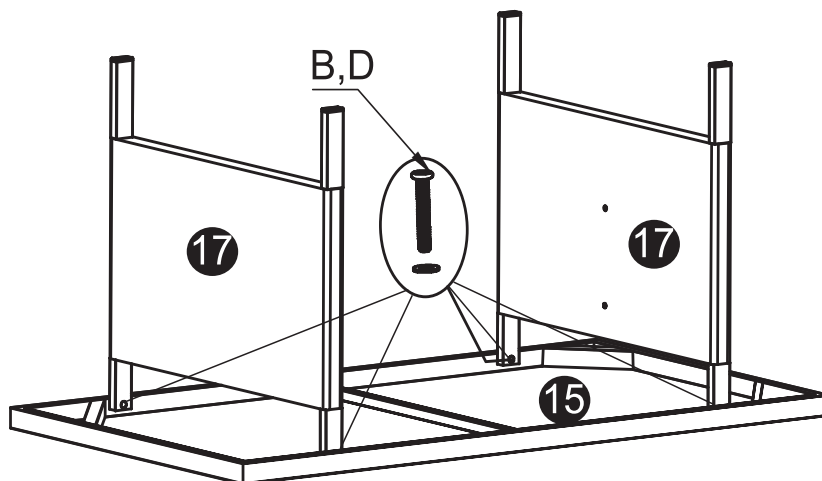
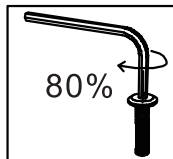

15

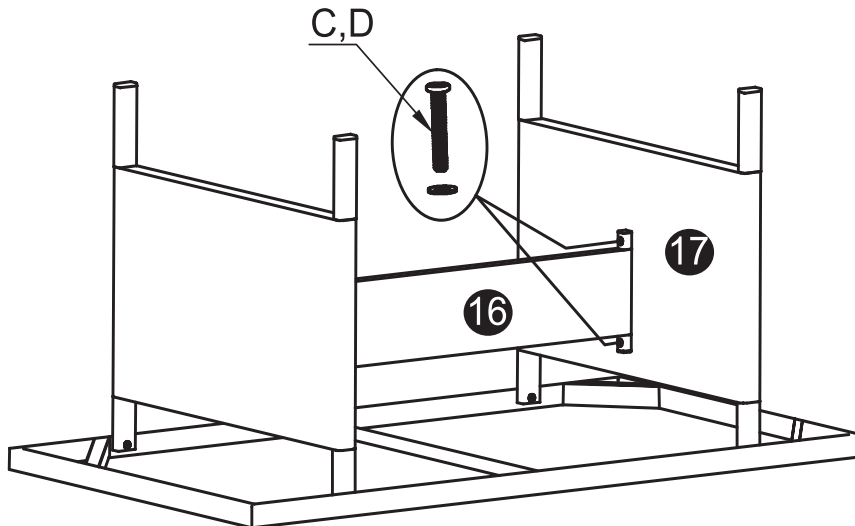
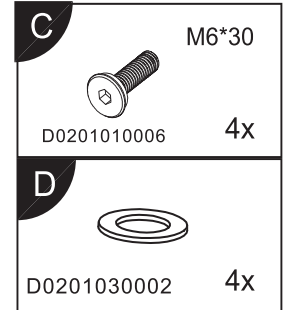
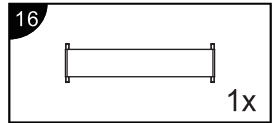
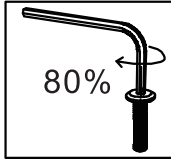

16

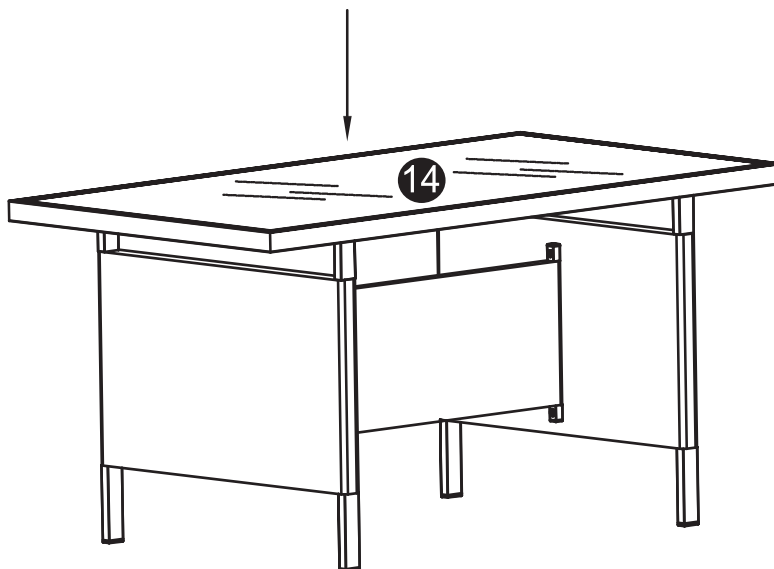
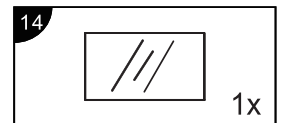
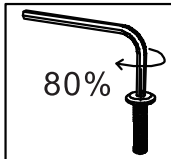

17

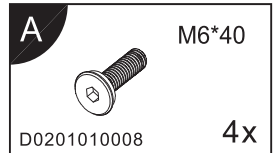
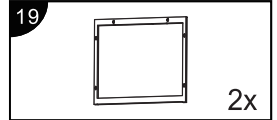
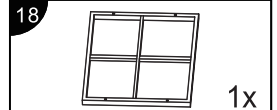
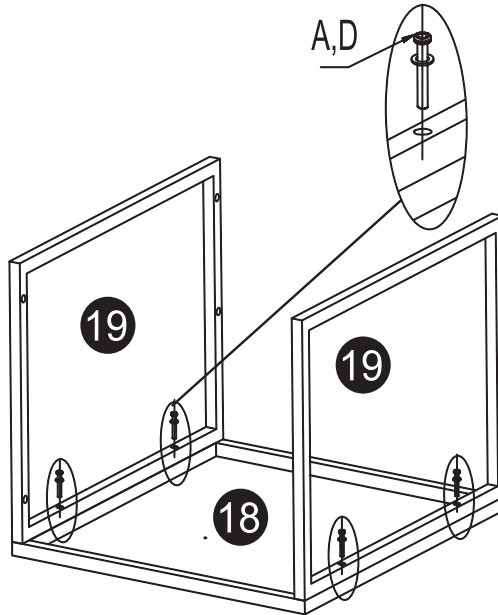
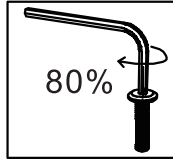

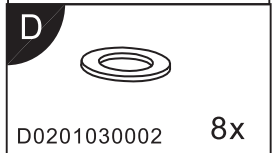
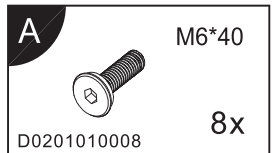
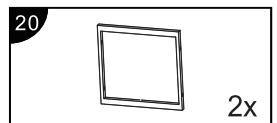
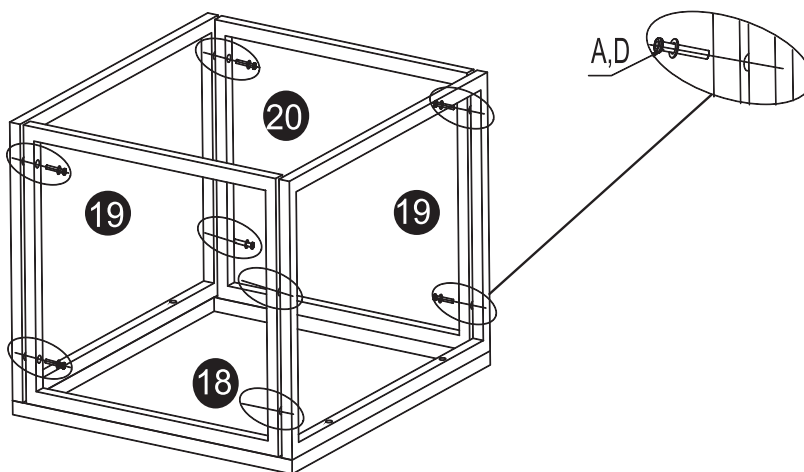
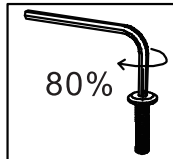

18

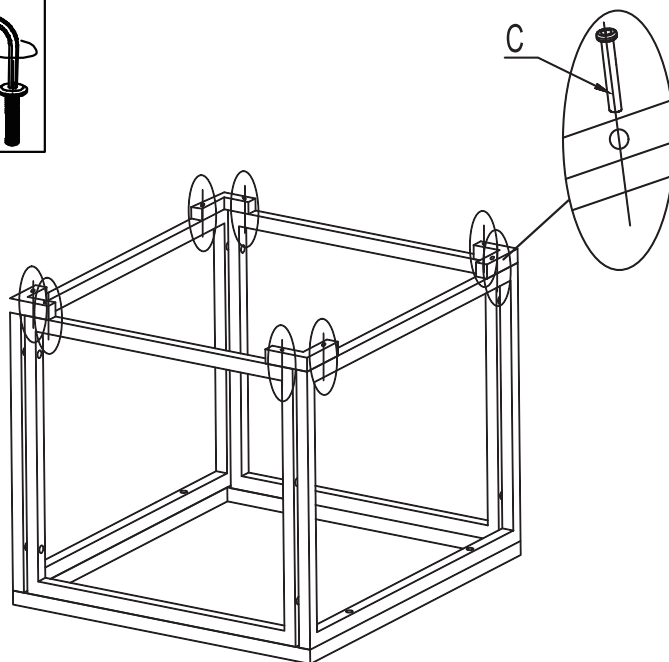
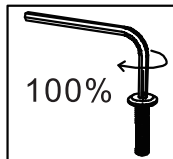

19

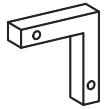

<b>E</b>		4x
<b>C</b>		M6*30 8x
D0201010006		

20

