

RAPID 4

INSTRUCTION MANUAL

- D** **WICHTIG** – BITTE SORGFÄLTIG LESEN UND FÜR SPÄTERES NACHLESEN UNBEDINGT AUFBEWAHREN!
- GB** **IMPORTANT** – READ CAREFULLY AND KEEP FOR FUTURE REFERENCE!
- NL** **BELANGRIJK** – LEES ZORGVULDIG EN BEWAR VOOR LATERE RAADPLEGING!
- F** **IMPORTANT** – À LIRE ATTENTIVEMENT ET À CONSERVER POUR RÉFÉRENCE ULTÉRIEURE!
- E** **IMPORTANTE** – LEER DETENIDAMENTE Y MANTENERLAS PARA FUTURAS CONSULTAS!
- P** **IMPORTANTE** – LEIA CUIDADOSAMENTE E GUARDE PARA REFERÊNCIA FUTURA!
- I** **IMPORTANTE** – LEGGERE ATTENTAMENTE E CONSERVARE PER FUTURO RIFERIMENTO!
- DK** **VIGTIGT** – LÆS OMHYGGELIGT OG GEM TIL SENERE BRUG!
- FIN** **TÄRKEÄÄ** – LUE HUOLELLISESTI JA SÄILYÄ VASTAISUUDEN VARALLE!
- S** **VIKTIGT** – LÄS NOGGRANT OCH SPARA FÖR FRAMTIDA BRUK!

- N** **VIKTIG** – LES NØYE OG OPPBEVAR FOR FREMTIDIG BRUK!
- RO** **IMPORTANT** – CITIȚI CU ATENȚIE ȘI PĂSTRAȚI ACEST DOCUMENT PENTRU CONSULTARE ULTERIOARĂ!
- BIH** **VAŽNO** – UPUTA SAČUVATI ZA KASNIJA PITANJA!
- TR** **ÖNEMLI** – DIKKATLI BIR ŞEKILDE OKUYUN VE ILERIDE BAŞVURMAK ÜZERE SAKLAYIN!
- SK** **DÔLEŽITÉ** – PRED POUŽITÍM PREČÍTAJTE POZORNE TENTO NÁVOD A USCHOVAJTE HO PRE BUDÚCU POTREBU!
- CZ** **DŮLEŽITÉ** – POKYNY SI POZORNĚ PŘEČTĚTE A USCHOVEJTE PRO POZDĚJŠÍ POUŽITÍ!
- H** **FONTOS** – FIGYELMESEN OLVASSA EL ÉS ŐRIZZE MEG KÉSŐBBI FELHASZNÁLÁS ESETÉRE!
- PL** **WAŻNE** – PRZECZYTAJ UWAGAŃNIE I ZACHOWAJ NA PRZYSZŁOŚĆ JAKO ODNIESIENIE!
- EST** **TÄHTIS** – LUGEGE HOOLIKALT JA HOIDKE ALLES EDASPIDISEKS KASUTAMISEKS!

- LV SVARĪGI** – PIRMS LIETOŠANAS UZMANĪGI IZLASIET ŠO INSTRUKCIJU, UN VĒLĀK TO TURIET PA ROKAI, LAI BŪTU KUR IESKATĪTIES!
- LT SVARBU** – ATIDŽIAI PERSKAITYKITE IR SAUGOKITE, KAD VĒLIAU GALĒTUMĒTE PASISKAITYTI!
- SLO POMEMBNO** – PRED UPORABO POZORNO PREBERITE NAVODILA IN JIH SHRANITE KOT NAPOTEK ZA V PRIHODNJE!
- HR VAŽNO** – SAČUVATI ZA SLUČAJ POTREBE!
- SRB VAŽNO** – PROČITAJTE PAŽLJIVO I SAČUVAJTE ZA KASNIJE PODSEĆANJE!
- GEO მნიშვნელოვანი** – შესაძლებელია მომავალში დაგებადოთ შეკითხვები. ამიტომ ინსტრუქცია კარგად შეინახეთ.
- GR ΣΗΜΑΝΤΙΚΟ** – ΔΙΑΒΑΤΕ ΠΡΟΣΕΚΤΙΚΑ ΤΙΣ ΟΔΗΓΙΕΣ ΚΑΙ ΦΥΛΑΞΤΕ ΤΕΣ ΓΙΑΤΙ ΜΠΟΡΕΙ ΝΑ ΤΙΣ ΧΡΕΙΑΣΤΕΙΤΕ ΣΤΟ ΜΕΛΛΟΝ!

RUS ВАЖНО – ИНСТРУКЦИЮ
СЛЕДУЕТ СОХРАНИТЬ ДЛЯ
БУДУЩЕГО ИСПОЛЬЗОВАНИЯ!

BG ВАЖНО – ПРОЧЕТЕТЕ
ВНИМАТЕЛНО И ЗАПАЗЕТЕ ЗА
БЪДЕЩИ СПРАВКИ!

MK ВАЖНО – ЗАЧУВАЈТЕ ГО
УПАТСТВОТО ЗА ПОВТОРНИ
ПРАШАЊА!

UA ВАЖЛИВО – ІНСТРУКЦІЮ СЛІД
ЗБЕРЕГТИ ДЛЯ МАЙБУТНЬОГО
ВИКОРИСТАННЯ!

AR هام – اقرأ التعليمات بعناية قبل الاستخدام
واحتفظ بها للرجوع إليها مستقبلا.

FA مهم – قبل از استفاده دستورالعمل ها را با
دقت بخوانید و برای مرجع بعدی نگه دارید.

CN 注意 – 请保留此说明书以便将来查阅!

TW 注意 – 請保留此說明書以便將來查閱!

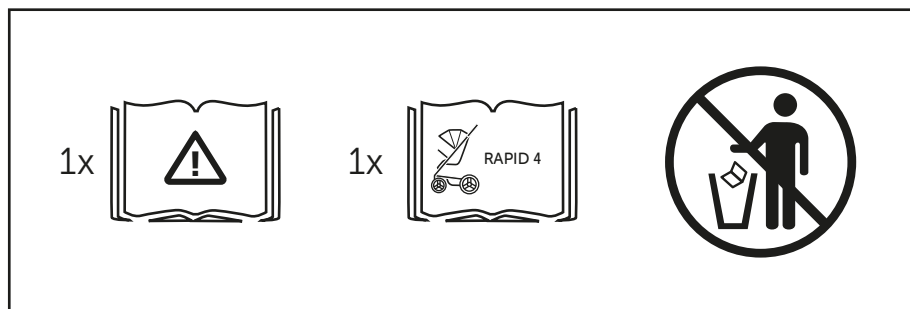



Rapid 4 & Rapid 4 Trio Set

Rapid 4

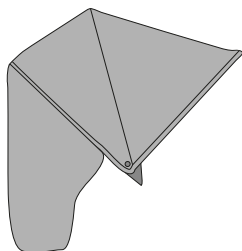
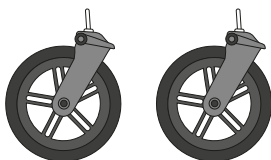
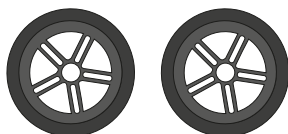
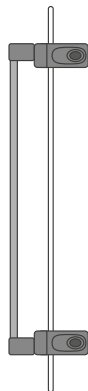
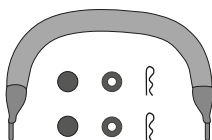
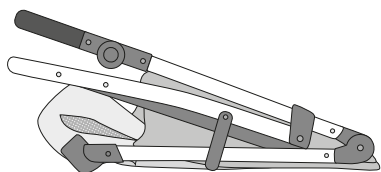

Rapid 4 Trio Set

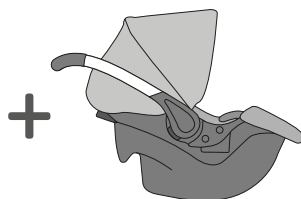
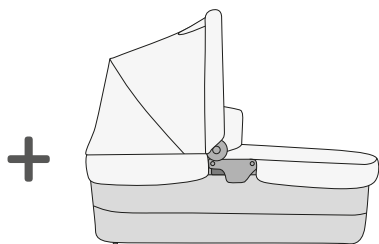

1a

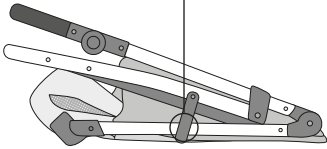
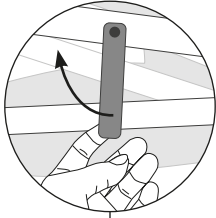
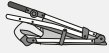

1b

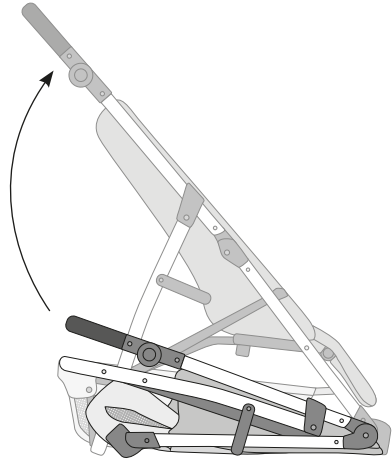
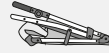

1c

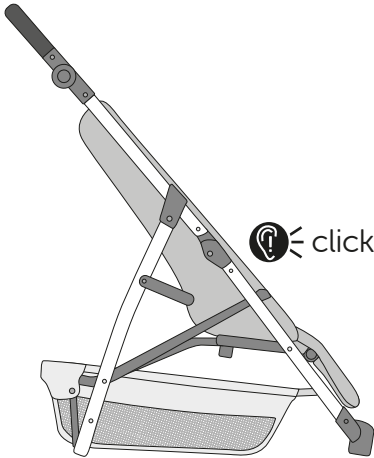

1d



1e

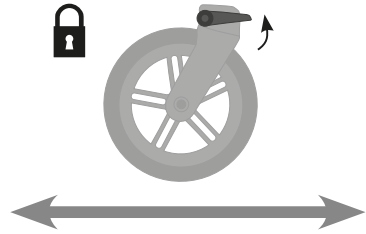
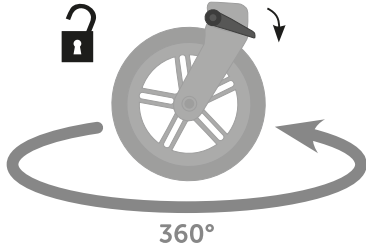

1f

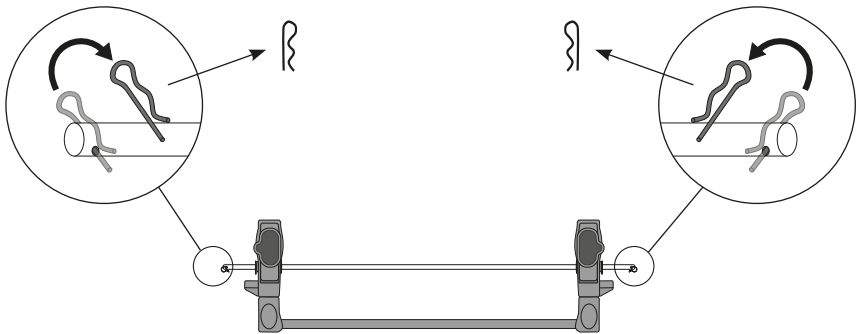
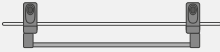

1g

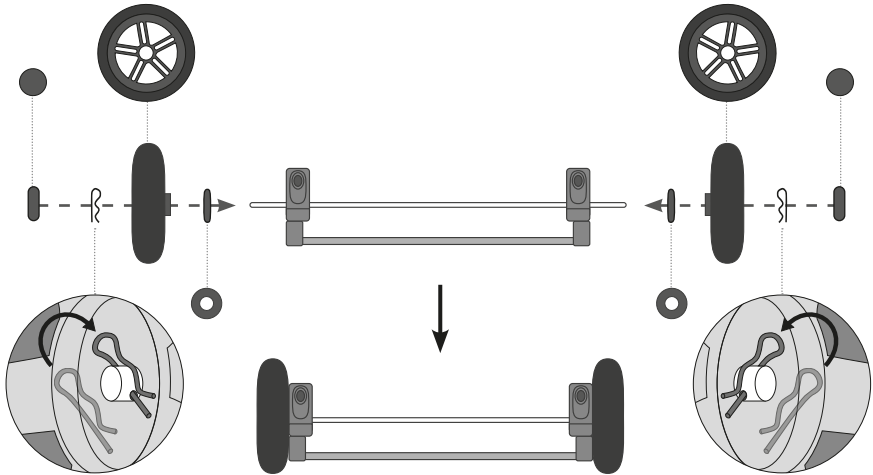

1h

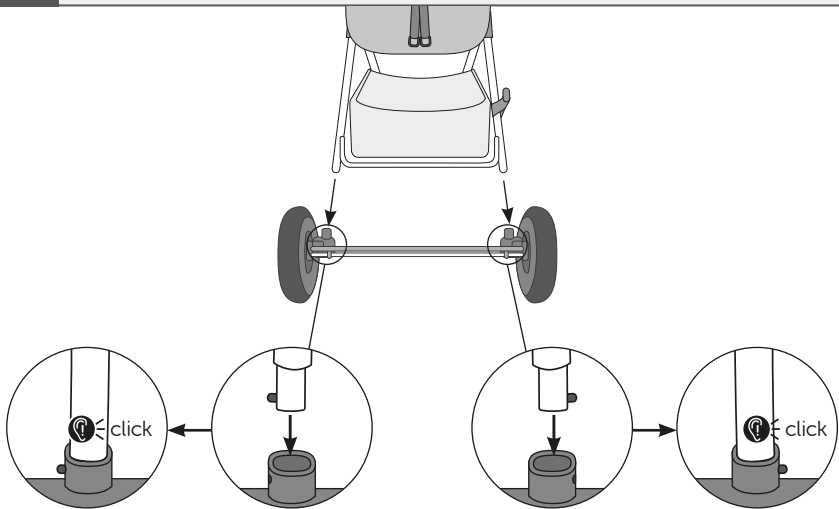
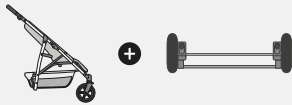

1i

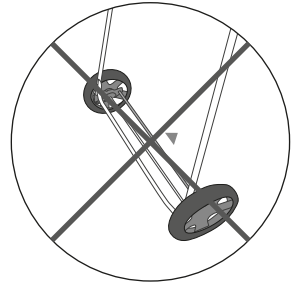
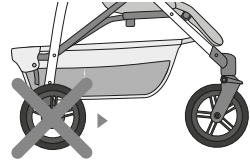
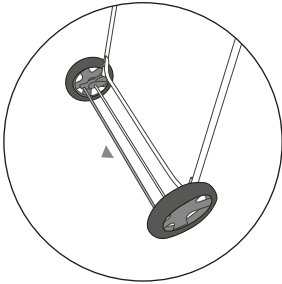
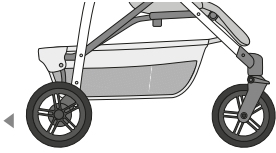

1j

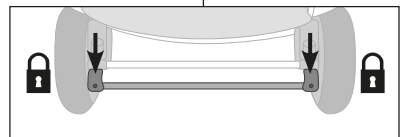
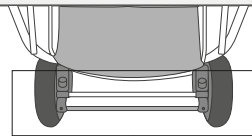
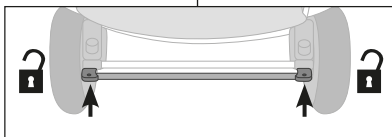
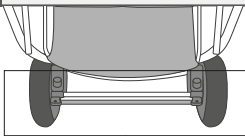

2a

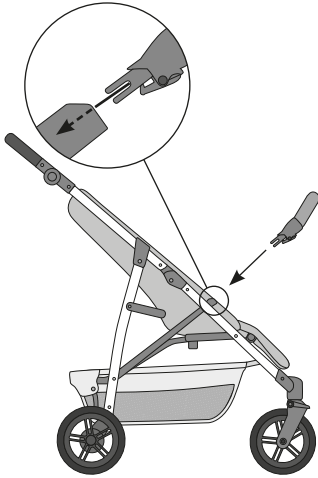

2b



2c

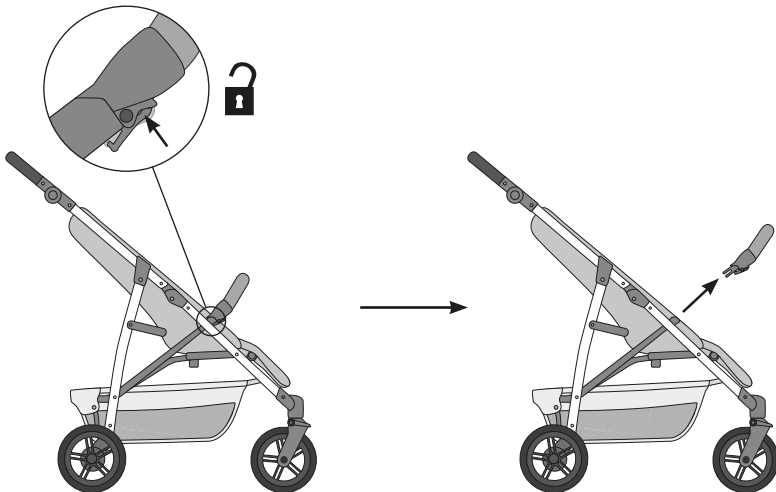

2d



2e

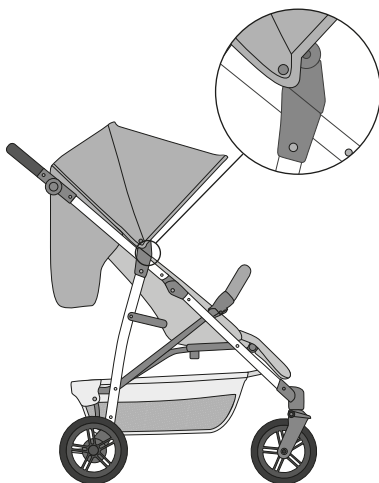

2f

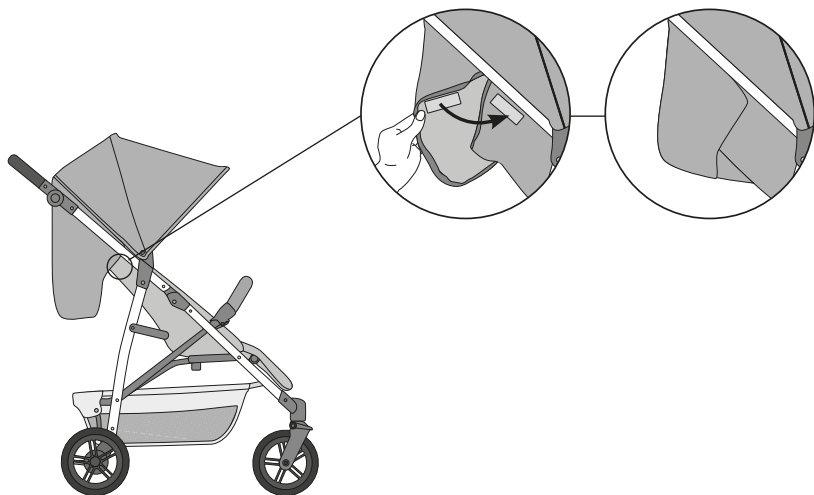

2g

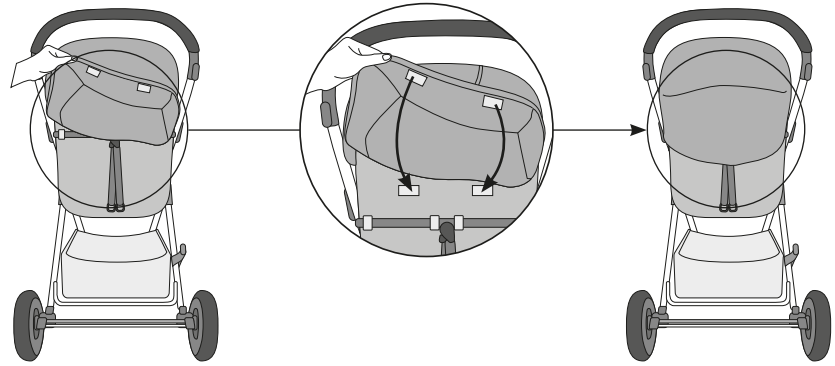

2h

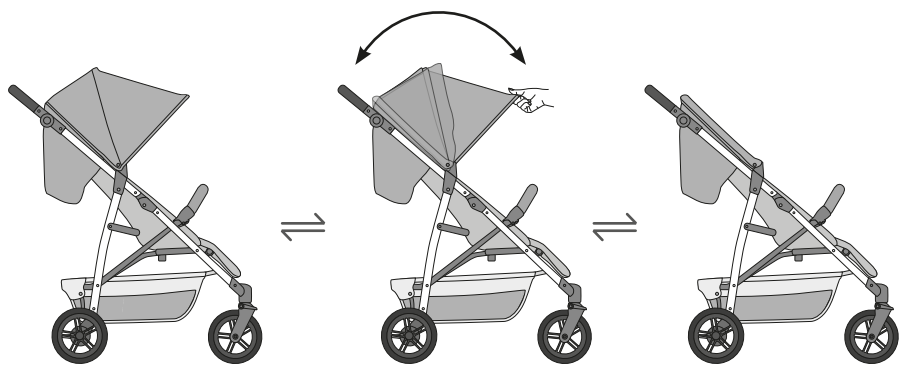

2i

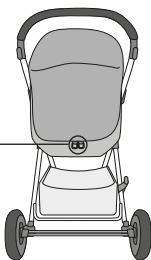
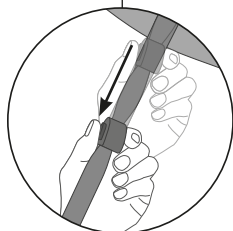
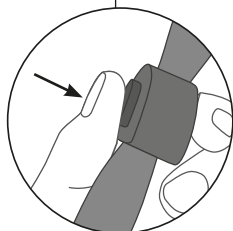
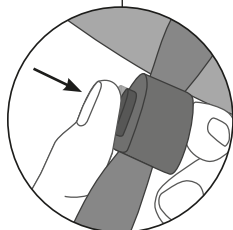
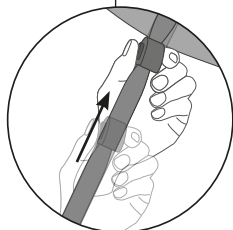

2j



2k



0+
MONTHS



2l

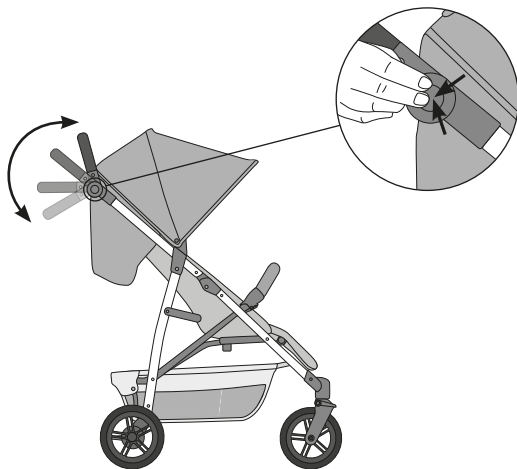

3a

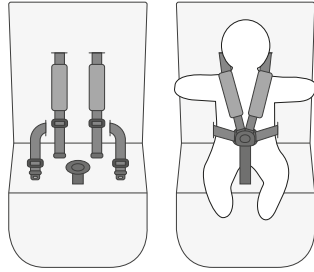
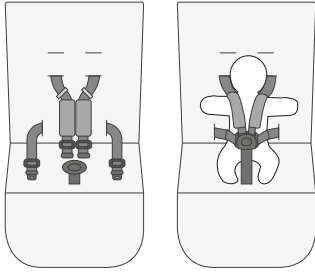

3b

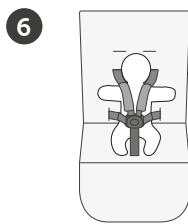
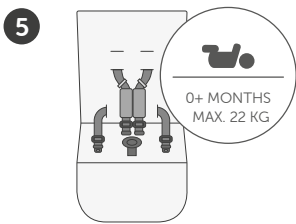
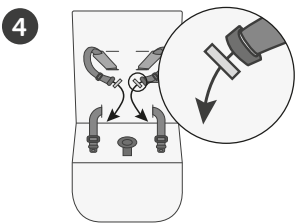
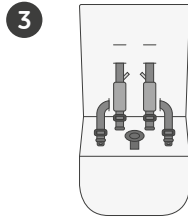
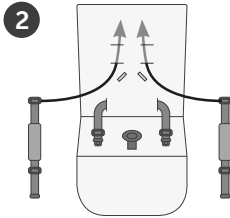
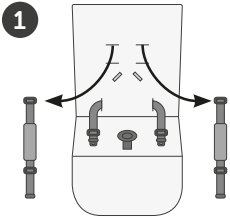

3c



1

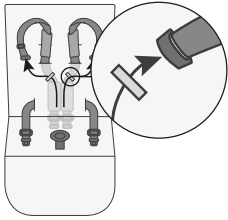

2

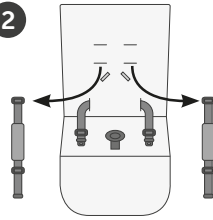

3

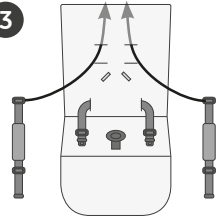

4

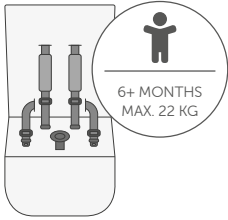

5

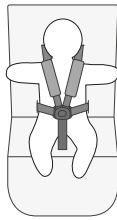

3d

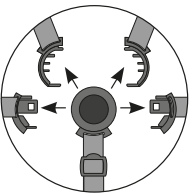
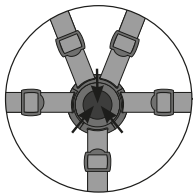
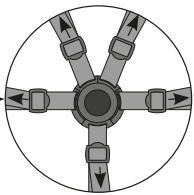
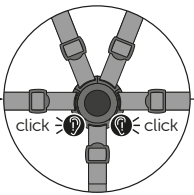
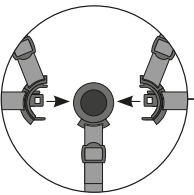
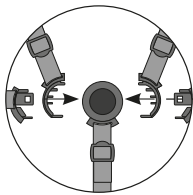

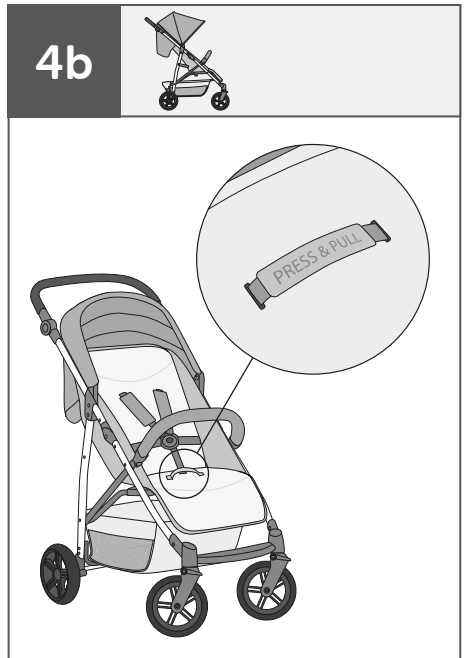
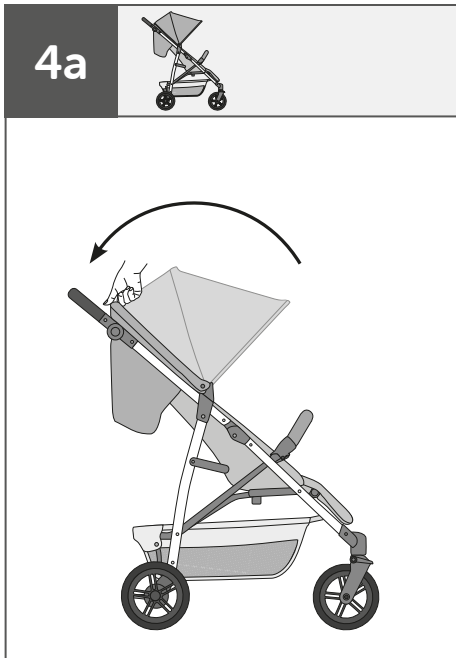
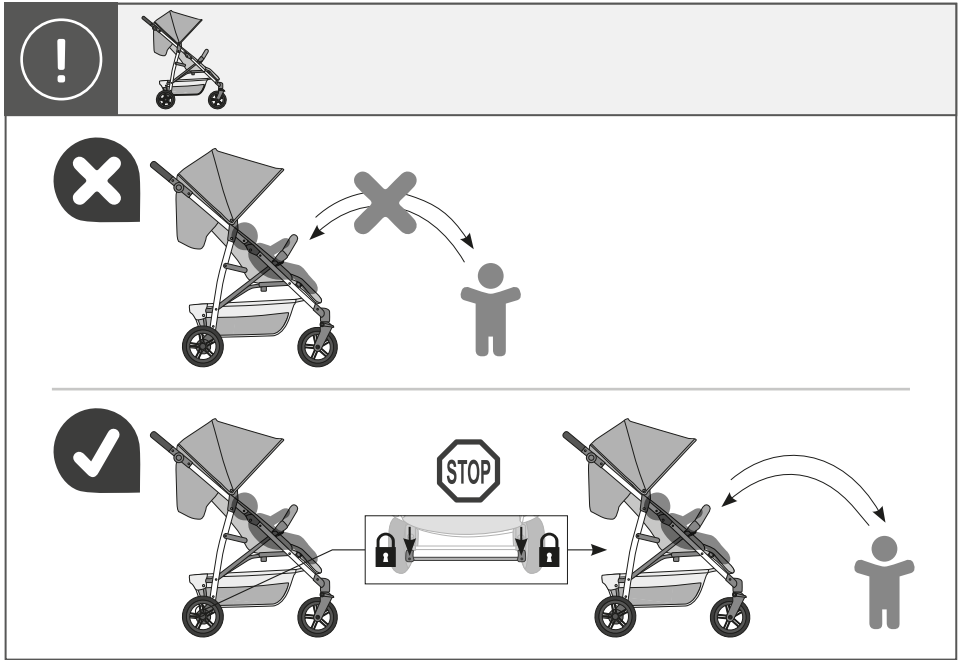

4c



↓ PRESS & PULL ↑

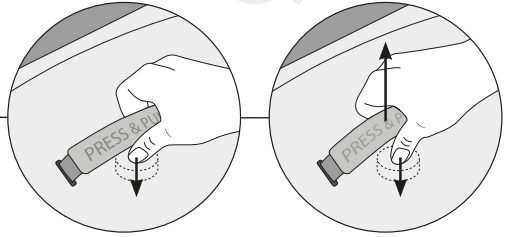

4d

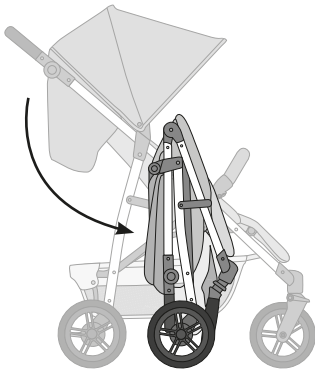

4e

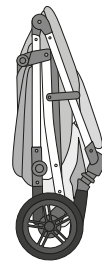

 click

4f

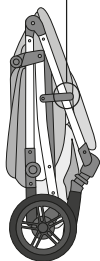
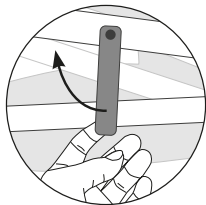

4g

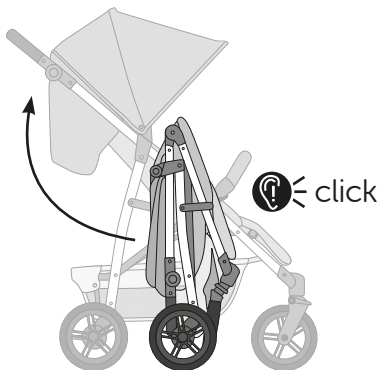

1

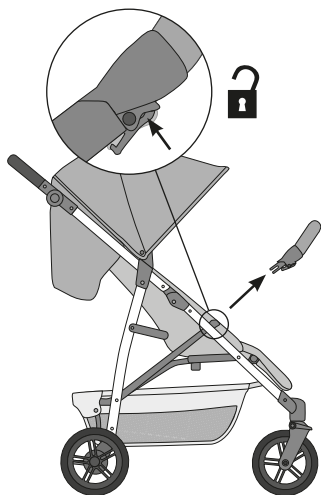

2

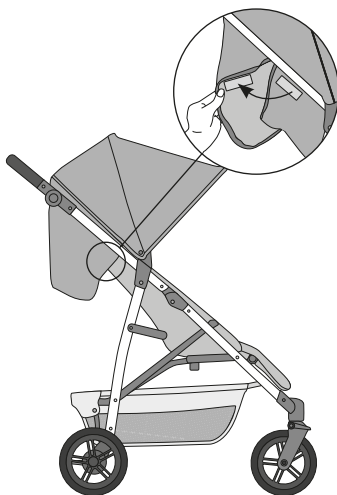

3

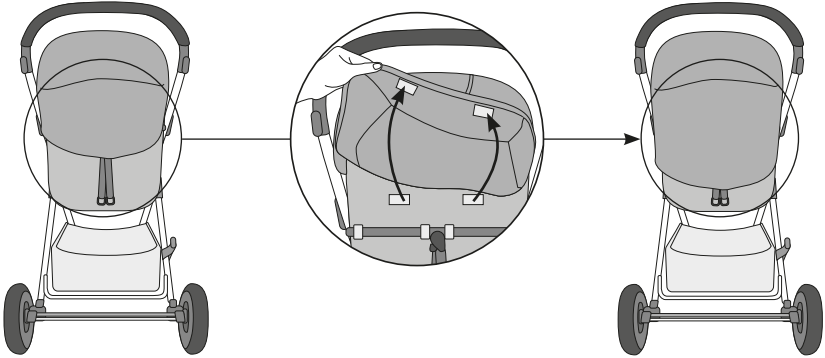

4



5

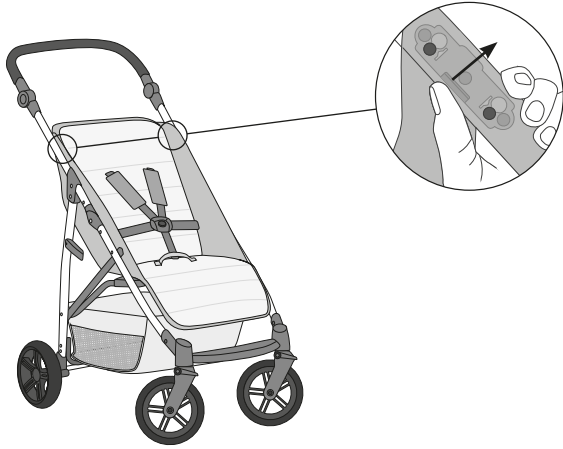

6

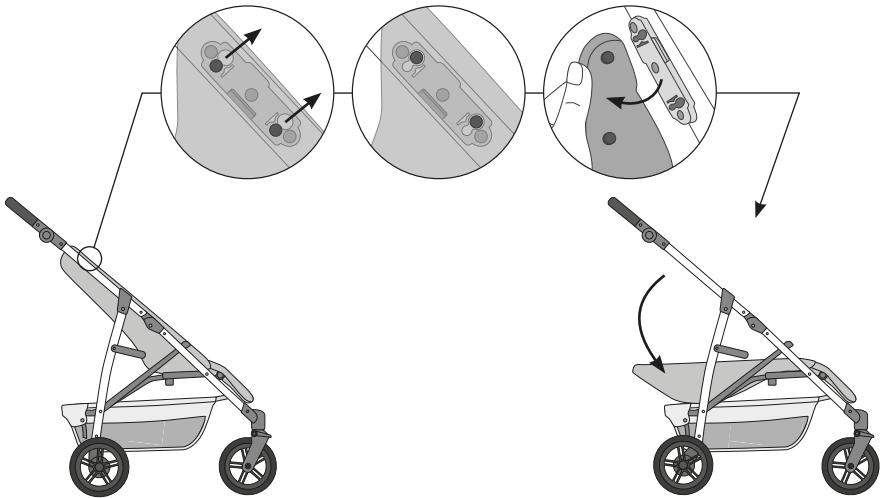

7

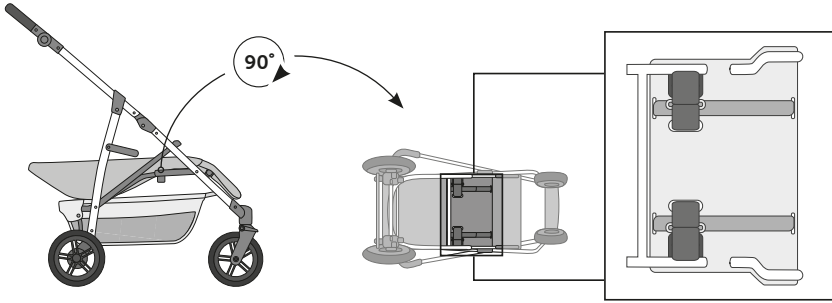

1

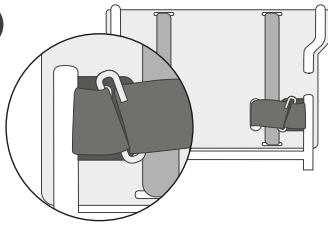

2

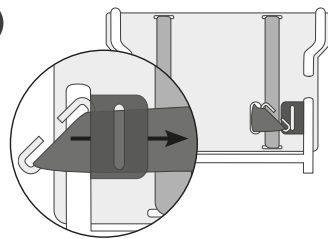

3

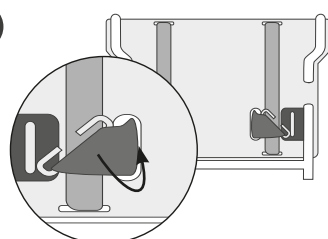

4

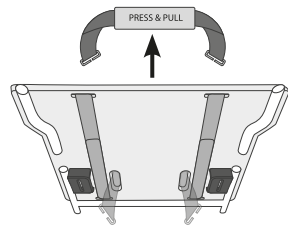

5

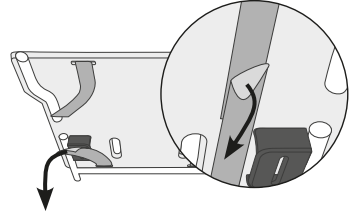

6

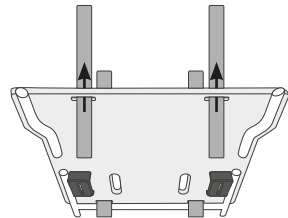

8

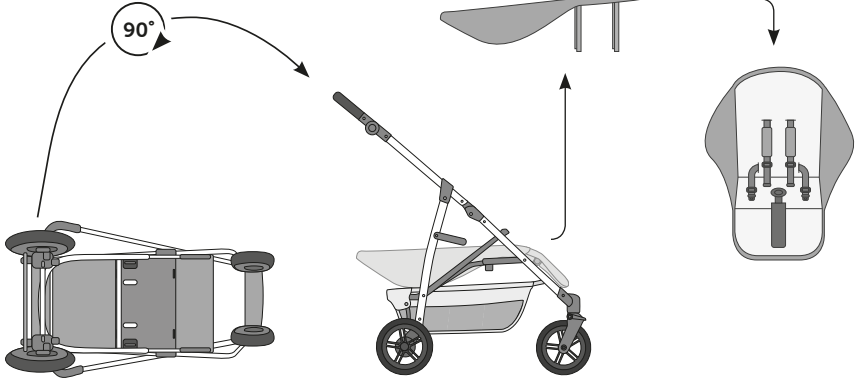

9

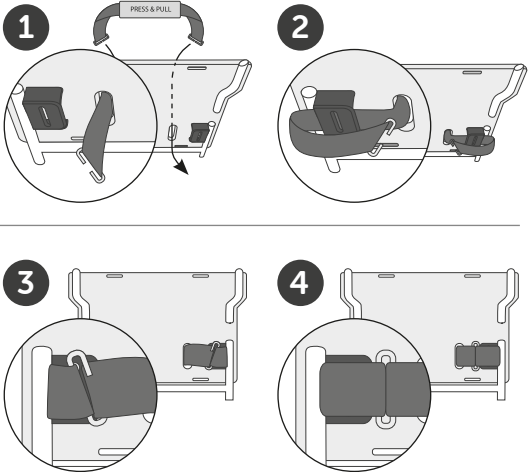



10



>> page 26

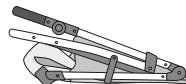

A1

>> page 28



B1

>> page 31



C1

>> page 37



10

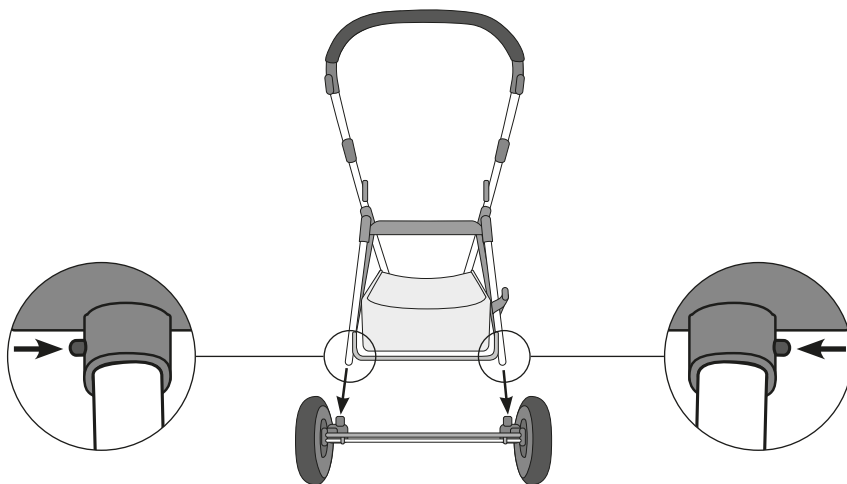

11

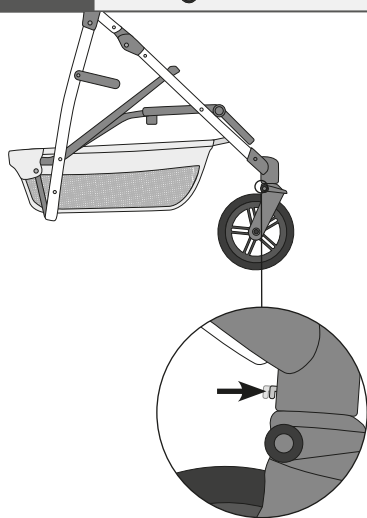

12

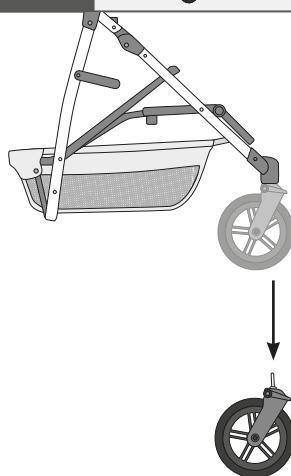

13

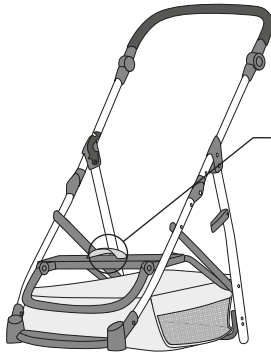

↓ PRESS & PULL ↑

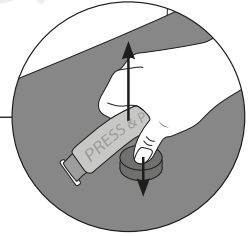
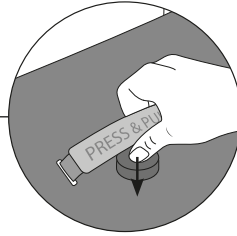

14

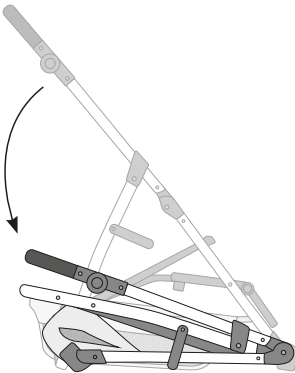

15

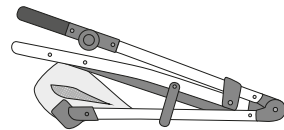

 click

A1



Comfort Fix
Rapid 4 Trio Set

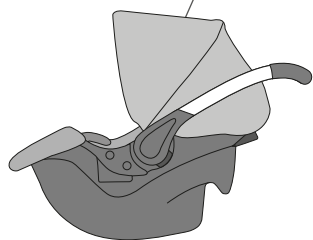

A2



A3

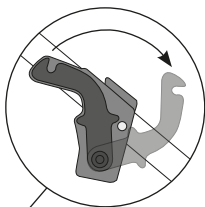

A4



A5

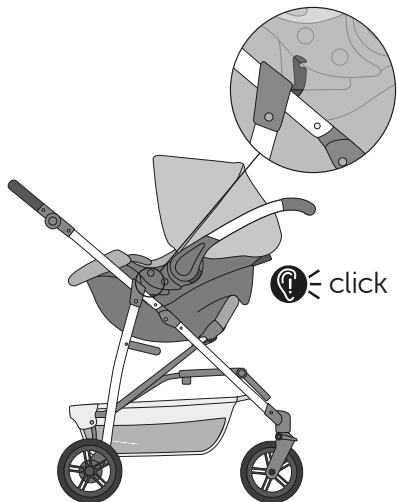

A6



A7

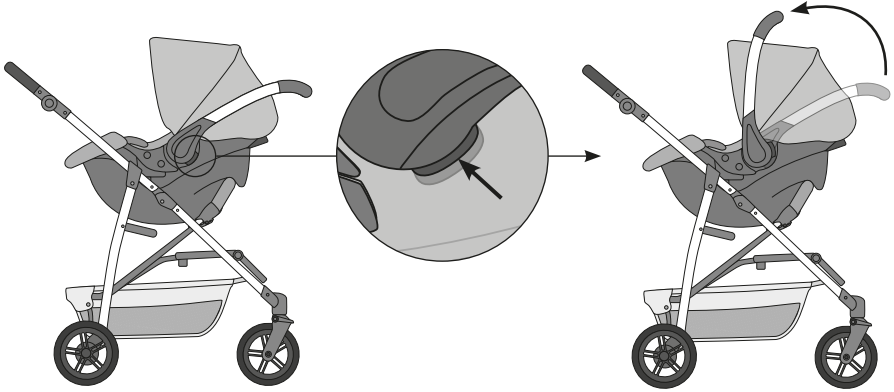

A8

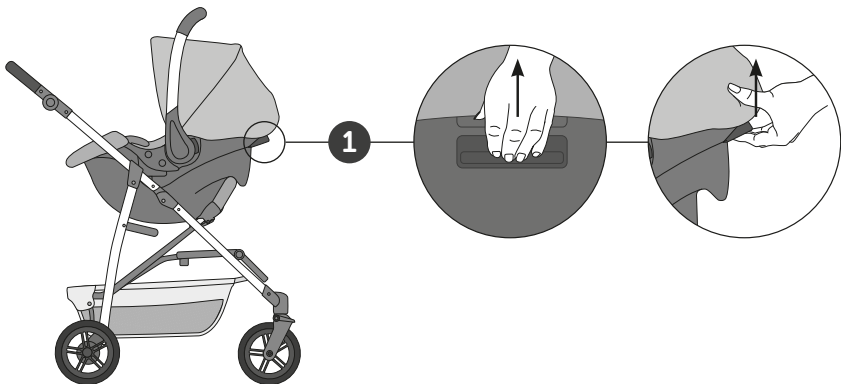

A9

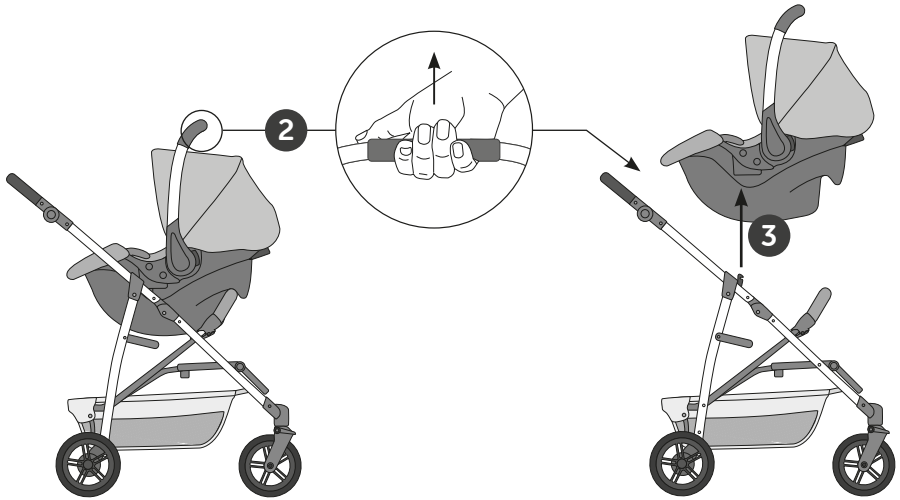

B1



Pram
Rapid 4 Trio Set

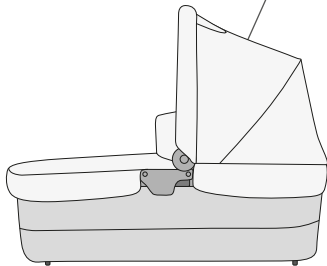

B2

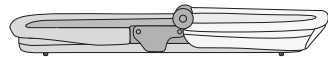
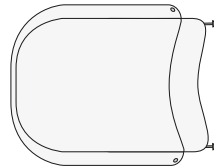

B3

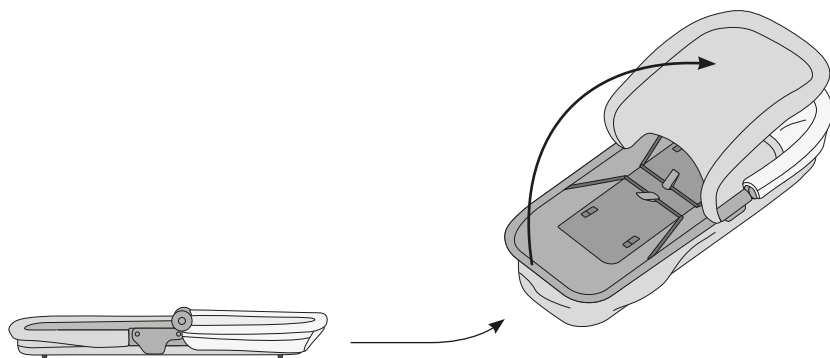
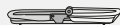

B4

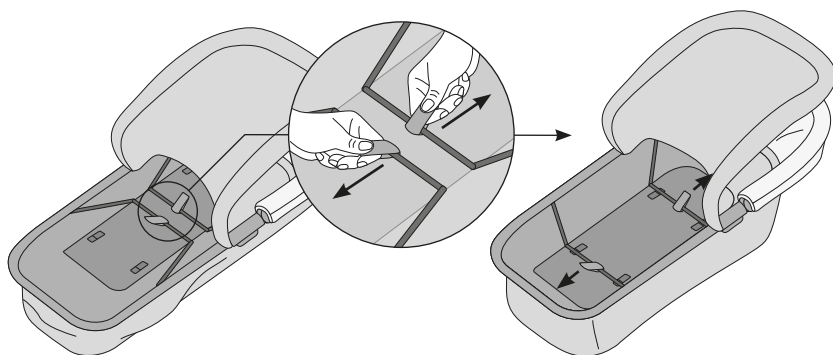

B5

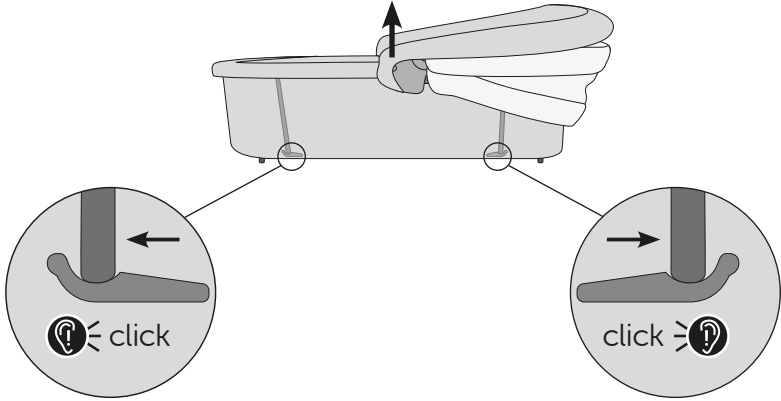
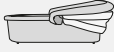

B6

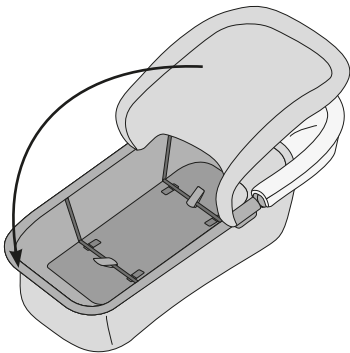
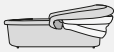

B7

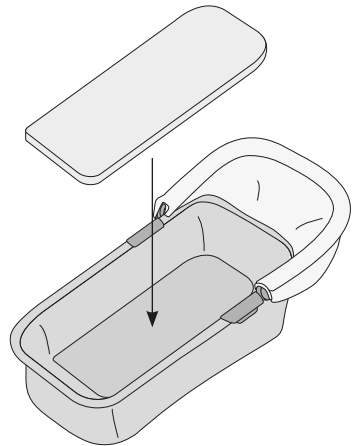
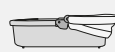

B8

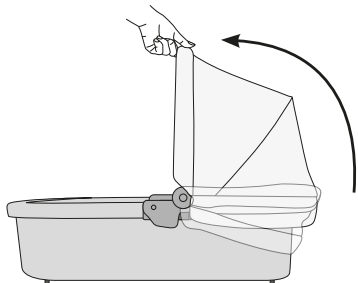
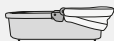

B9

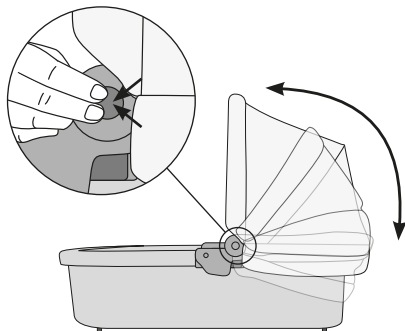
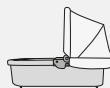

B10

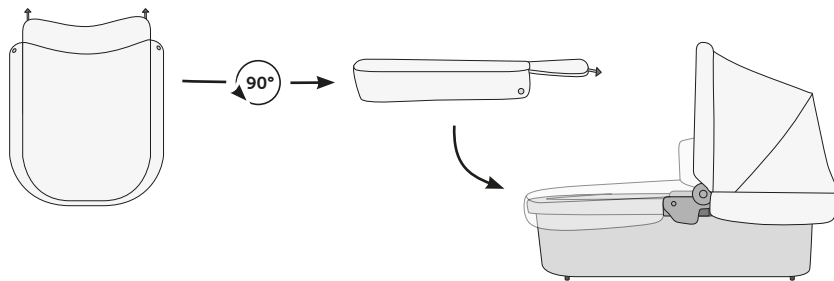

B11

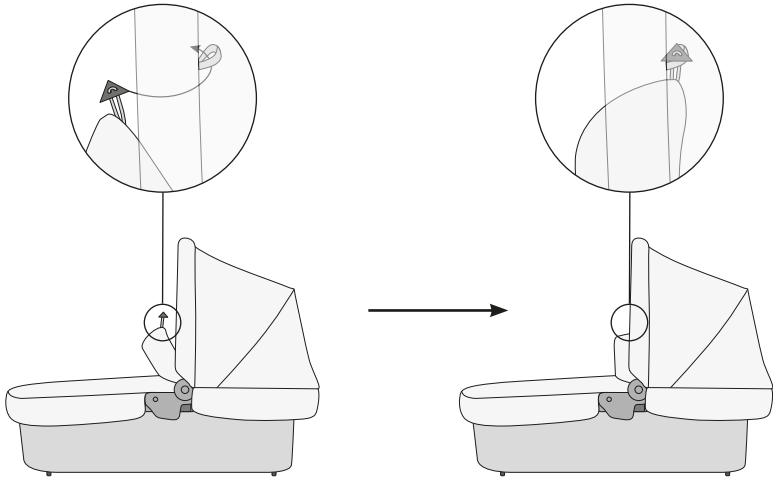
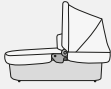

B12

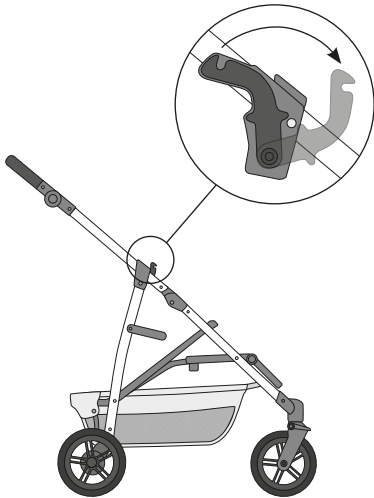

B13

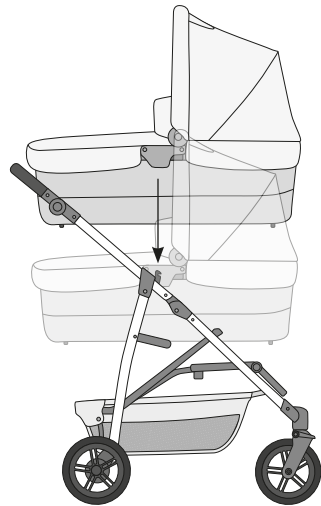

B14

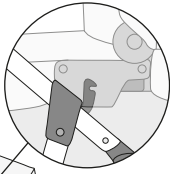

B15



B16

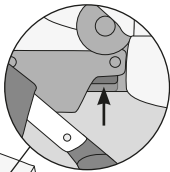

B17

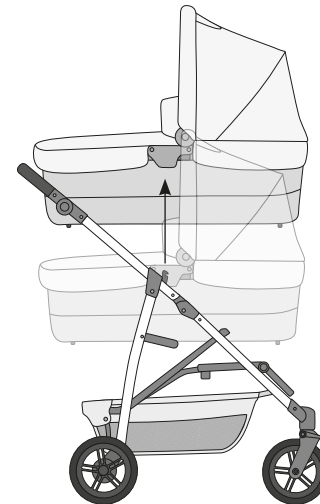

C1

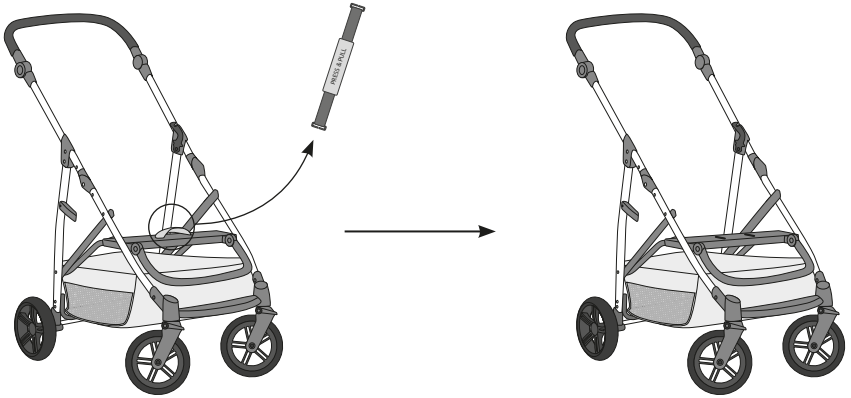

C2

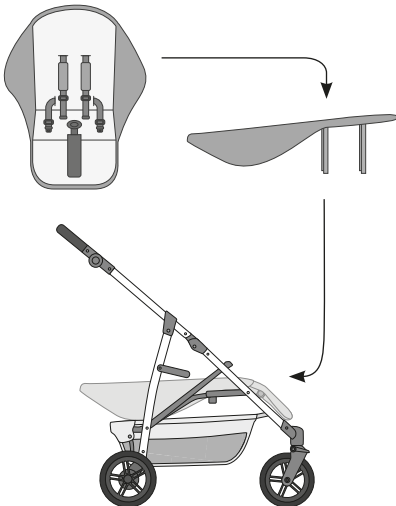

C3

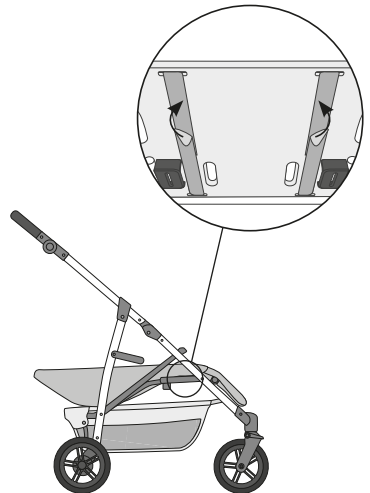

C4

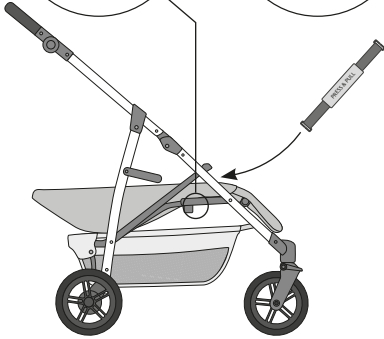
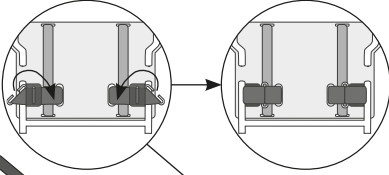

C5

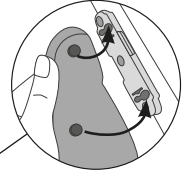

C6

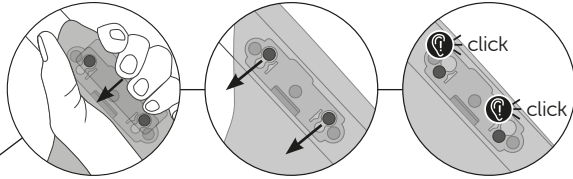

C7

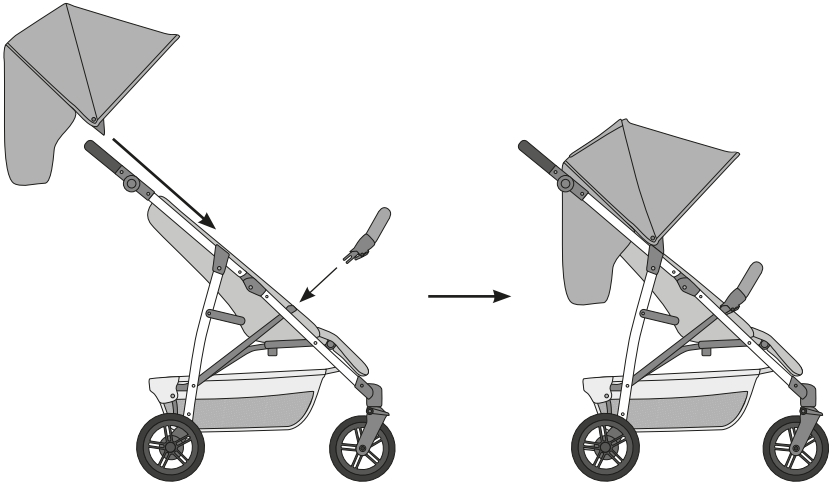

C8

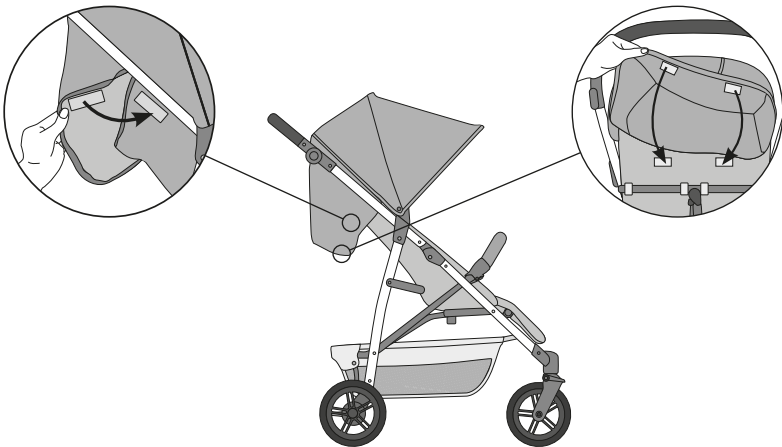



hauck GmbH & Co. KG
Frohnlaicher Str. 8
96242 Sonnefeld
Germany

phone: +49(0) 9562 986-0
fax: +49(0) 9562 6272
mail: info@hauck.de
web: www.hauck.de

hauck UK Ltd
Ash Road South
Wrexham Industrial Estate
Wrexham, LL13 9UG, UK

phone: +44(0) 1978 664362
fax: +44(0) 1978 661056
mail: info@hauckuk.de