

(D) Montageanleitung

(FR) Notice de montage

(NL) Handleiding voor de montage

(GB) Assembly instructions

(IT) Istruzioni di montaggio

(PL) Instrukcja montażu

(CZ) Montážní návod

(HU) Szerelési útmutató

(TR) Montaj talimati

(SK) Návod na montáž

(RU) Instrucțiuni de montaj

(RU) Инструкция по монтажу



# "LYON"

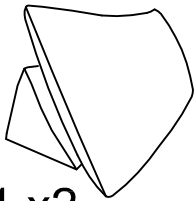

P1 x2



Fx 8

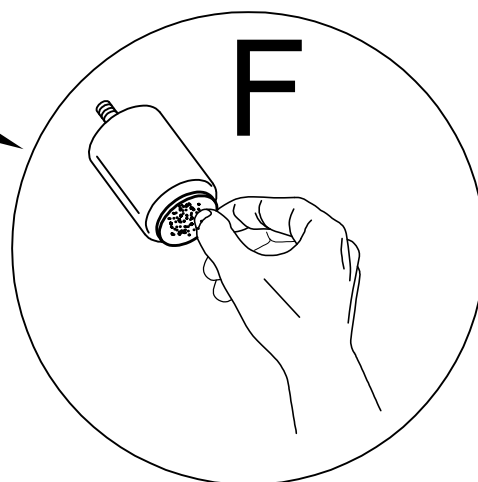
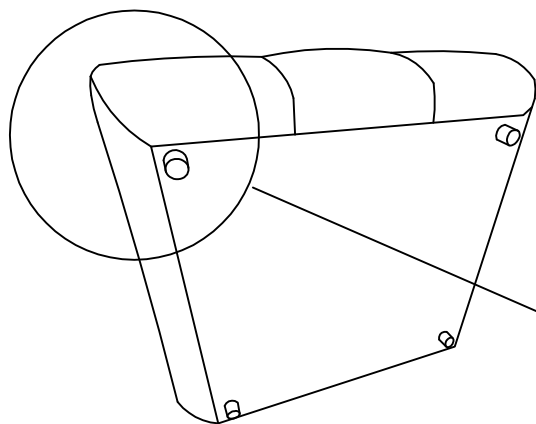
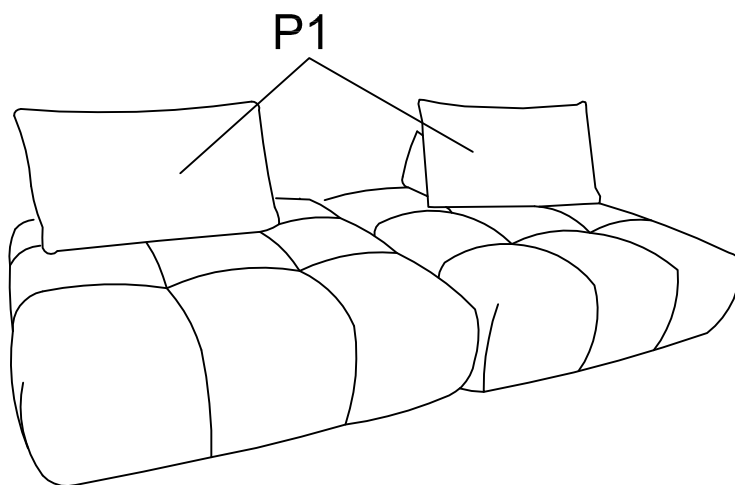
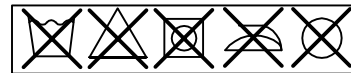

Name \* Nom \* Nome \* Naaz \* Nazwa \* Jméno  
Názov \* Név \* Denumire \* Isim \* Название

"LYON"

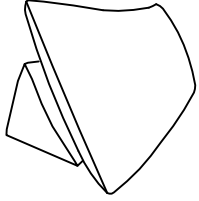
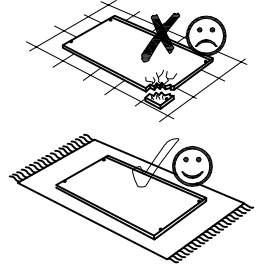
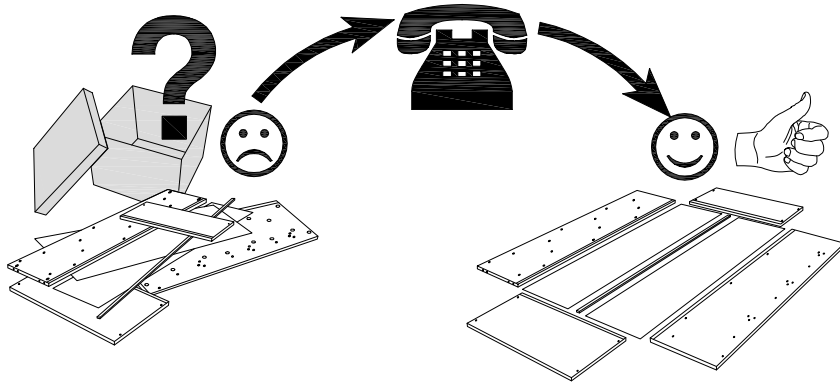
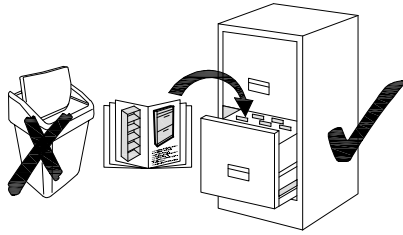

P1.....

F.....

P1

