

D22 F (DF 20)

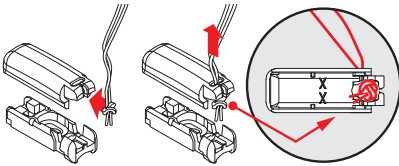

Bitte nur beiliegende Schrauben verwenden.

Please use enclosed screws only.

Proszę używać tylko wkrętów załączonych w opakowaniu.

Используйте только шурупы, находящиеся в приложении к упаковке.

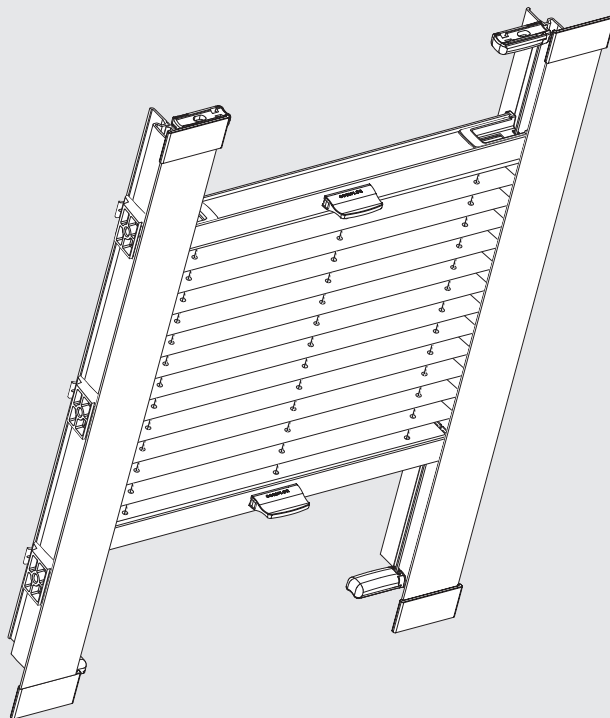

Wichtig! Bitte mit der Pflegeanleitung aufbewahren! • Important! Please keep together with care instructions!
Ważne! Proszę przechowywać z instrukcją pielęgnacji! • Внимание! Хранить вместе с инструкцией по эксплуатации!

Montage
Fitting
Montaż
Монтаж

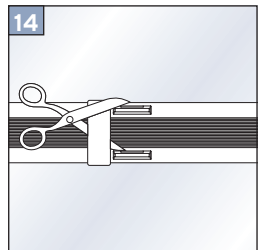
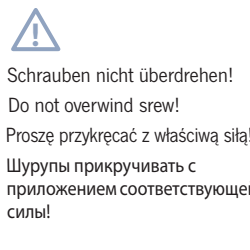
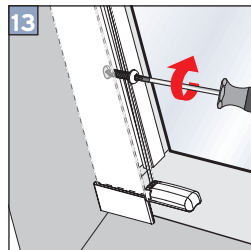
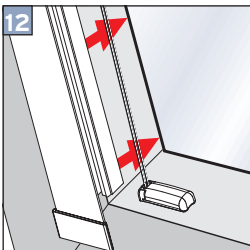
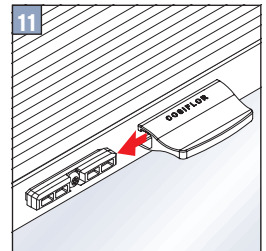
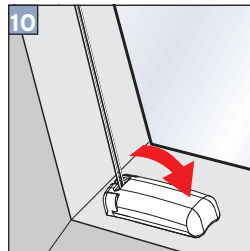
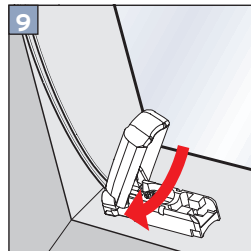
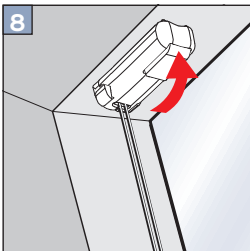
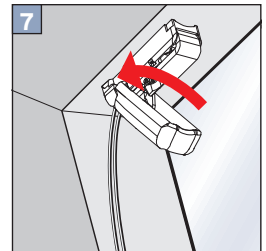
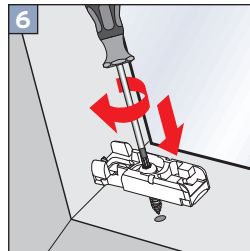
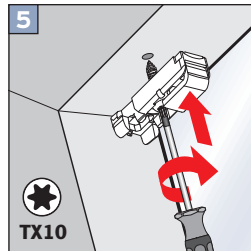
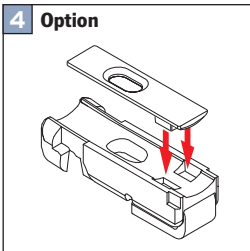
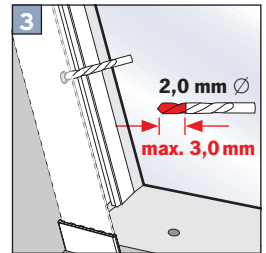
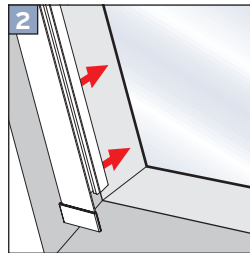
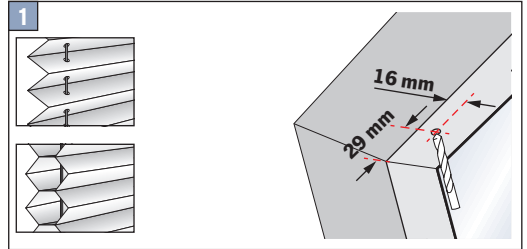
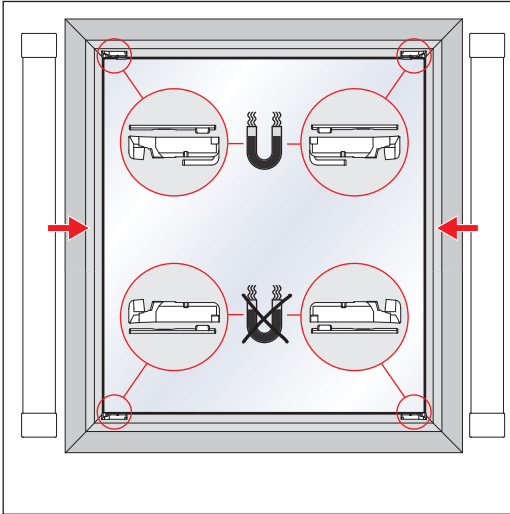
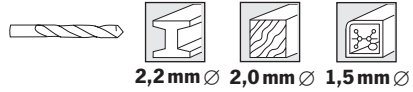

Bedienung • Operation • Obsługa • Управление

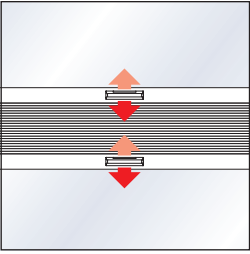

Demontage • Disassembly • Demontaż • Демонтаж

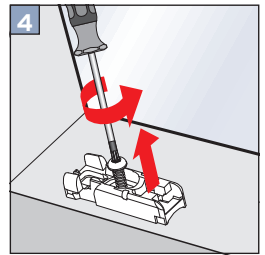
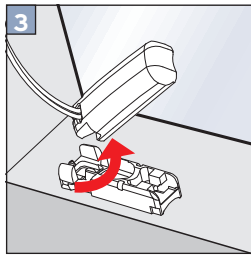
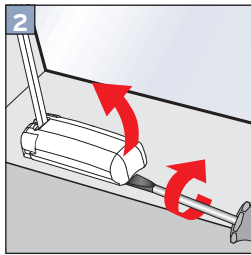
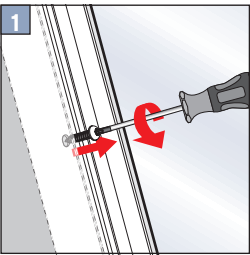

Option • Opcja • Вариант

