

DE Montageanleitung

FR Notice de montage

NL Handleiding voor de montage

CZ Montážní návod

HU Szerelési utmutato

TR Montaj talimatı

GB Assembly instructions

IT Istruzioni di montaggio

PL Instrukcja montažu

SK Návod na montáž

RO Instrucțiuni de montaj



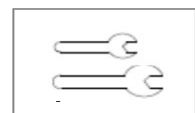
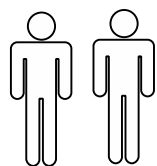



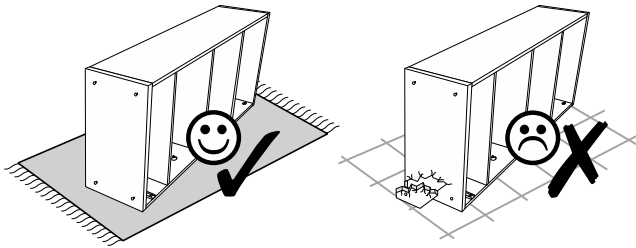
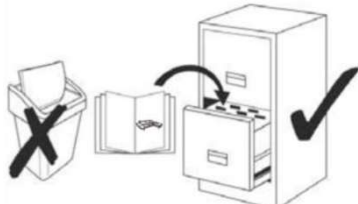
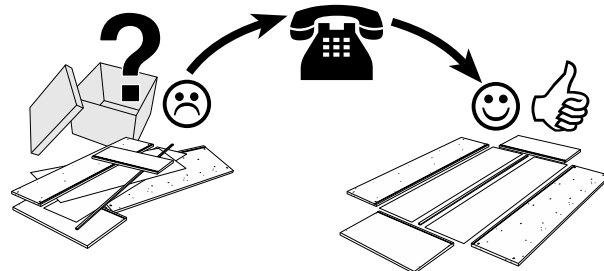













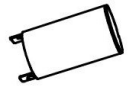
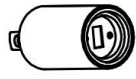

RU Инструкция по монтажу



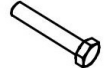

**Service – Assistenza – Dienstverlening – Serwis
 Servis – Szerviz – Сервисная служба**

Name - Nom - Nome - Naam - Nazwa – Jméno – Názov – Név – Denumire – İsim - Название			
Nr. – No. – N° - Номер – Č - Sz	85543524/ 65248518		
Typ – Type – Tip – Típus – Tipo - Тип	Pavillon		
			

Hinweis: Geeignet als Sonnenschutz und leichter Regenschutz.

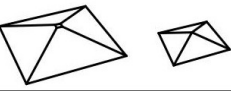
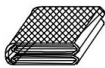
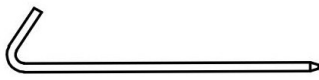
A	2	
B	2	
C	2	
D	2	
E	4	
E1	4	
F	4	
G	3	
H	1	
I	8	
J	1	
K	1	
L	1	
L1	1	
L2	1	
M	4	
N	4	
O	4	
P	28	
Q	44	
R	4	
S	76	
T	36	
U	16	

V	1	
W	2	
X	4	
Y	8	
		

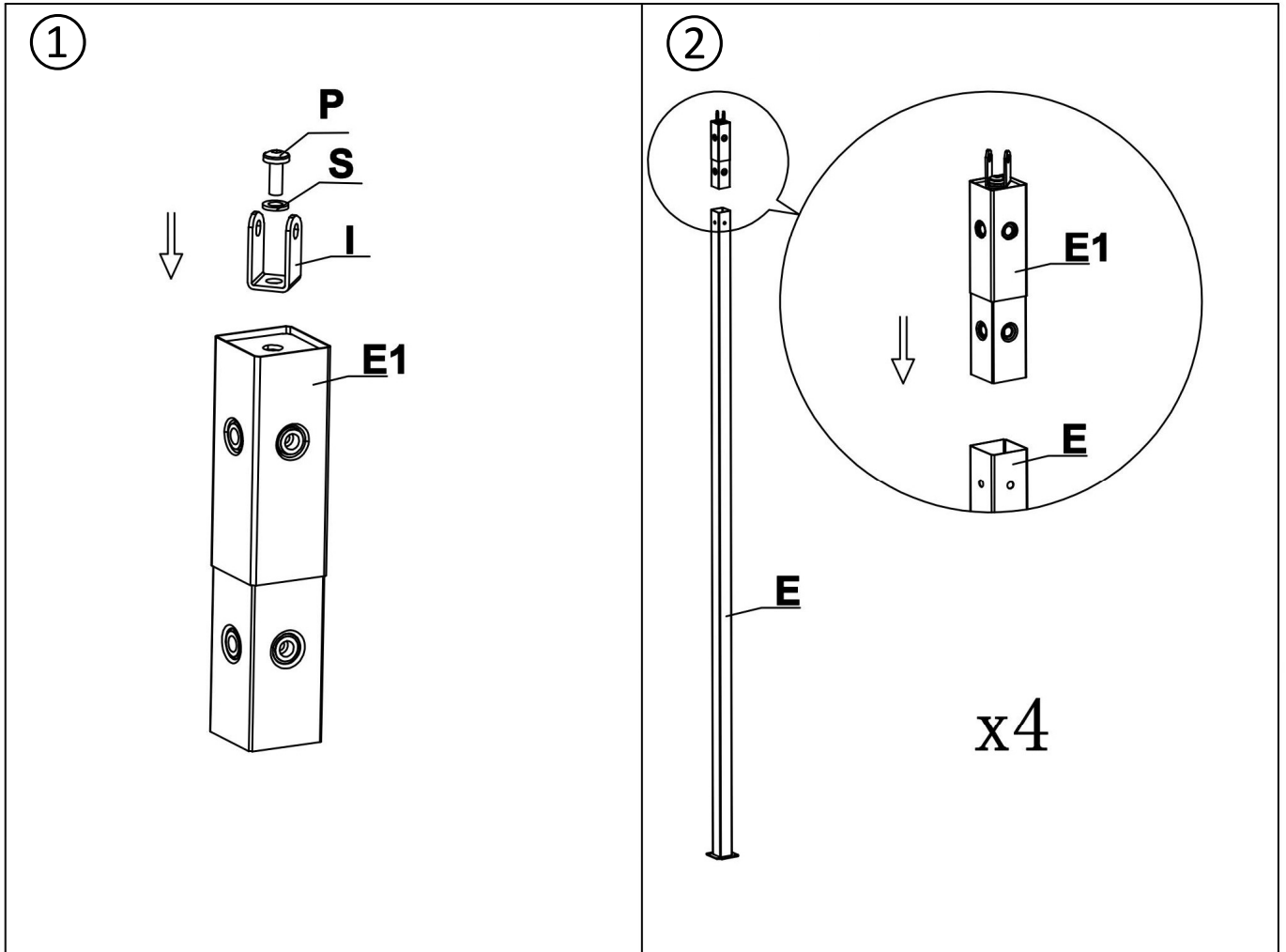

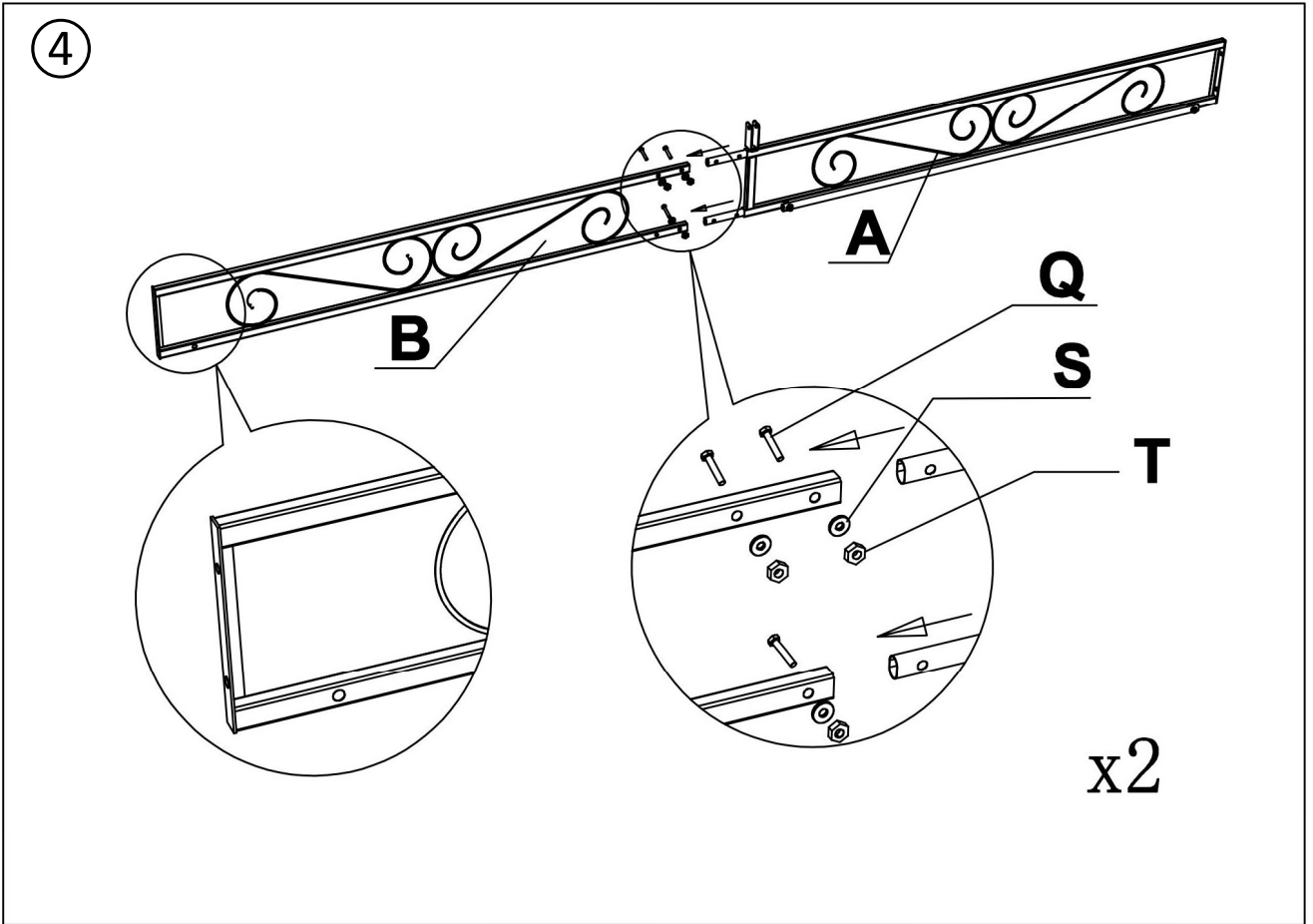
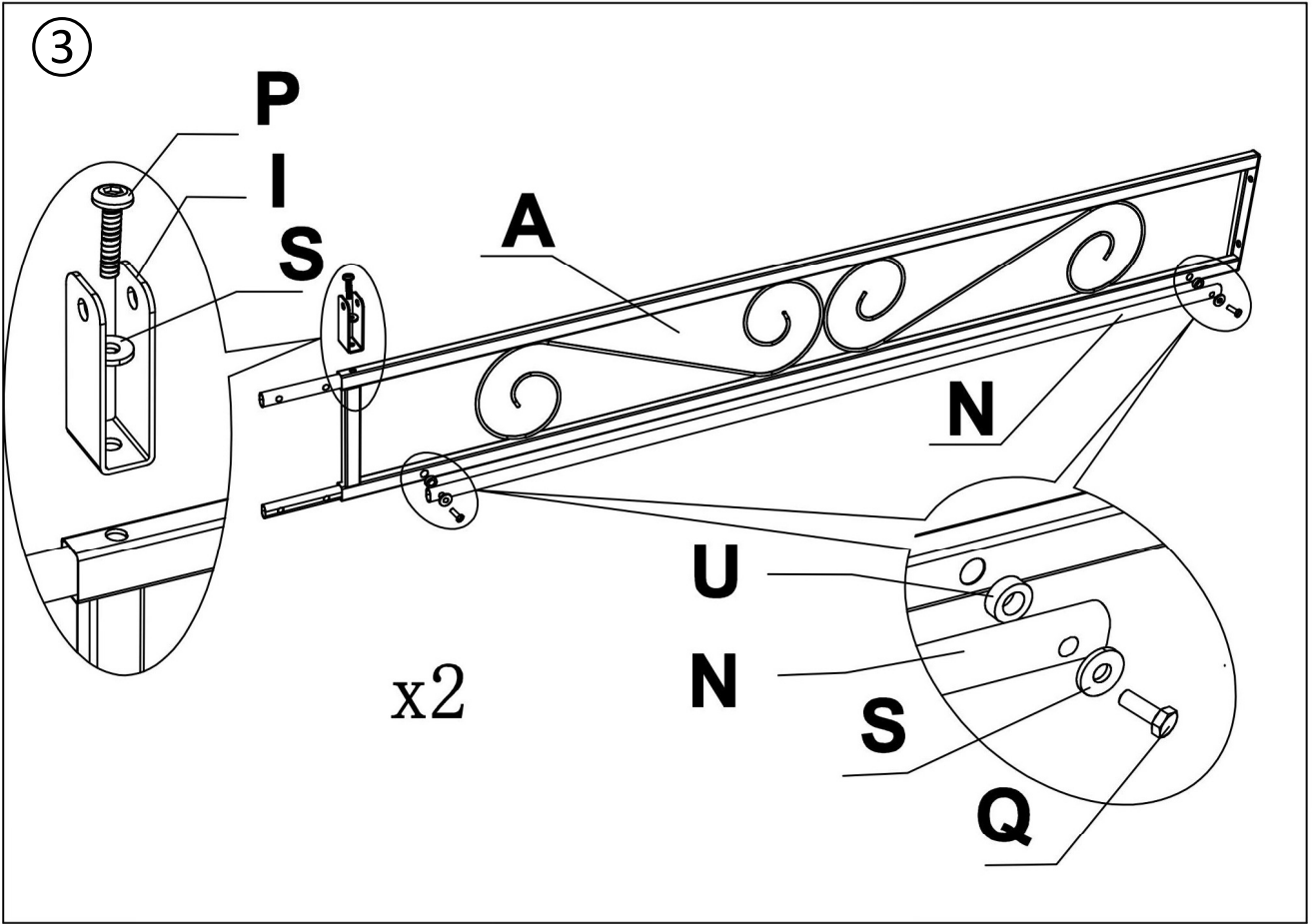

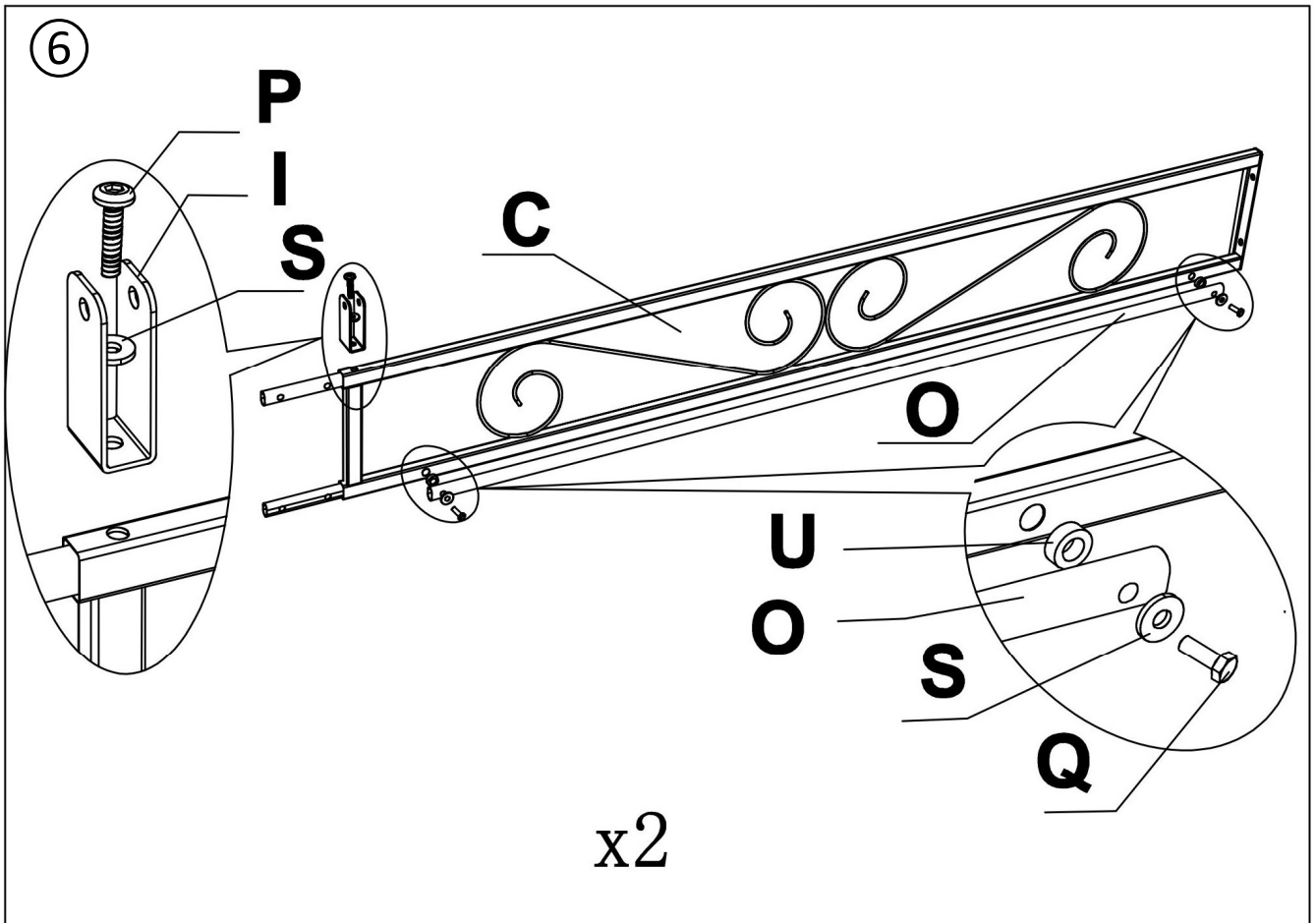
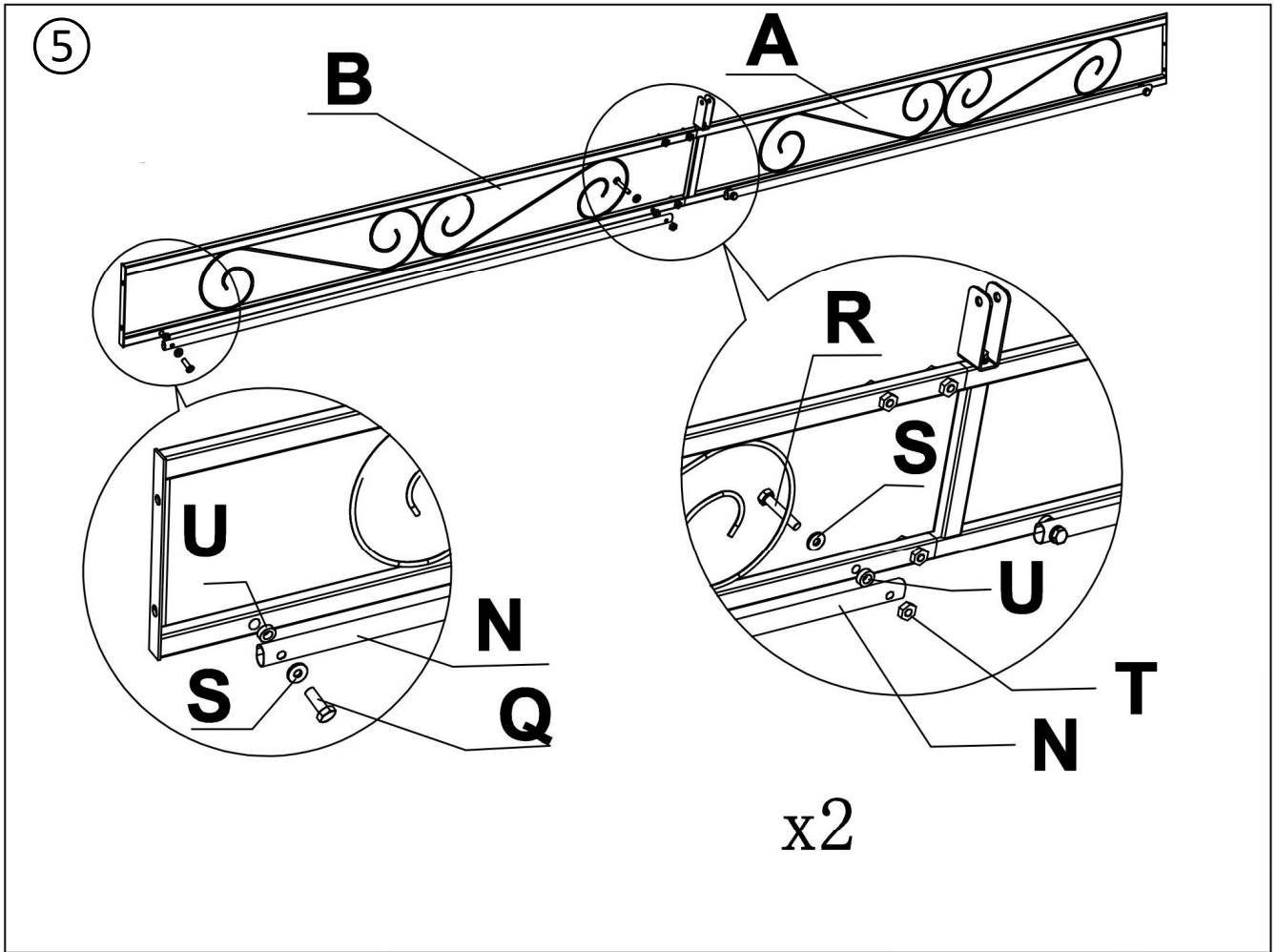

7

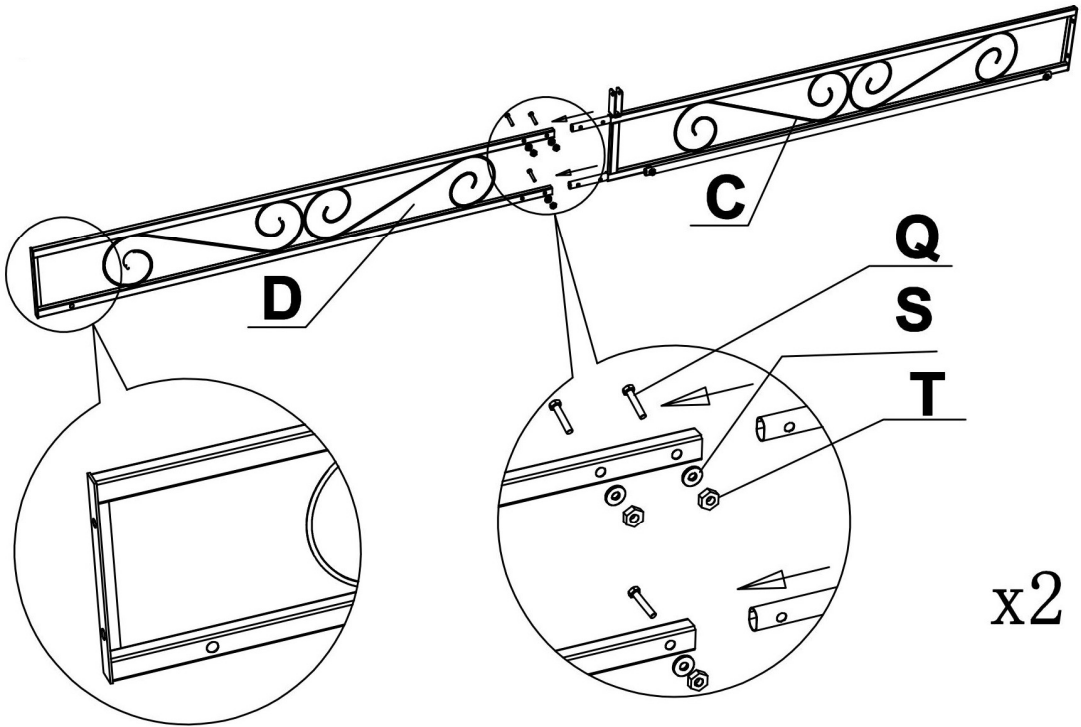

8

