

# P185 / P208

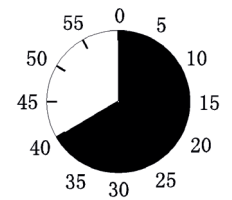

1

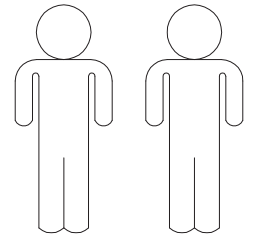
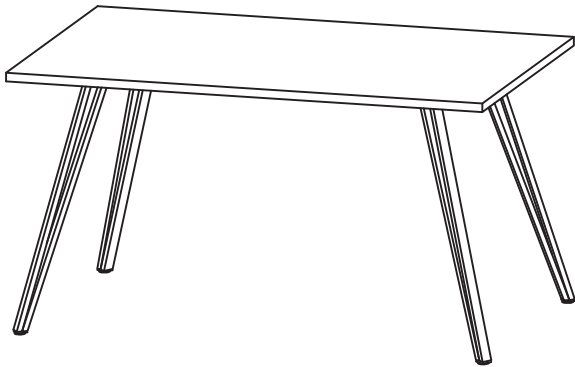
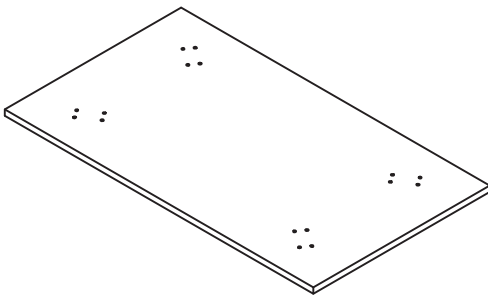

2

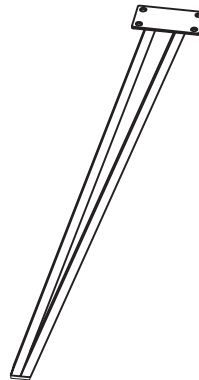

1	1x	1/2
2	4x	2/2

<b>A</b>	M8*12  16X	<b>B</b>	M8*16  16X	<b>C</b>	Ø18*Ø8*1.5  16X	<b>D</b>	Ø25  4X	<b>E</b>	5mm  1X
<b>F</b>	8mm  1X								

I.

1.

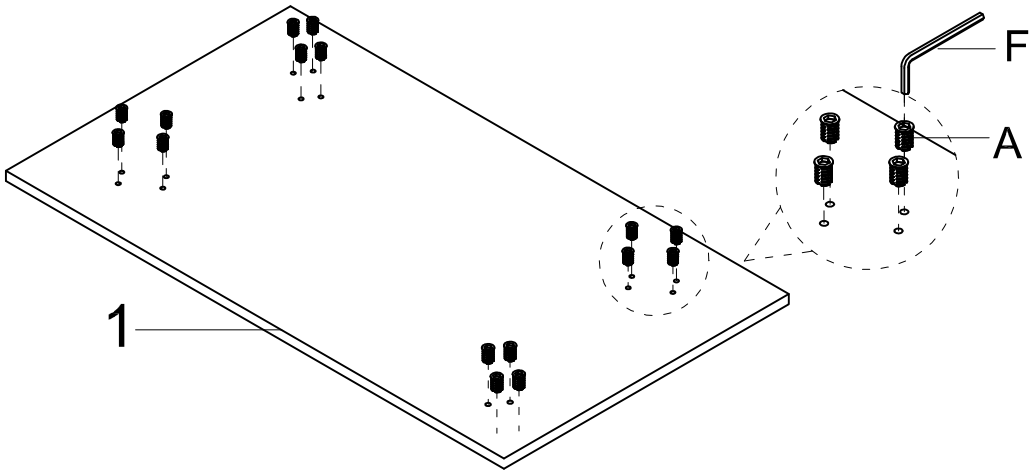

A

M8\*12  
16X

F

8mm  
1X



2.

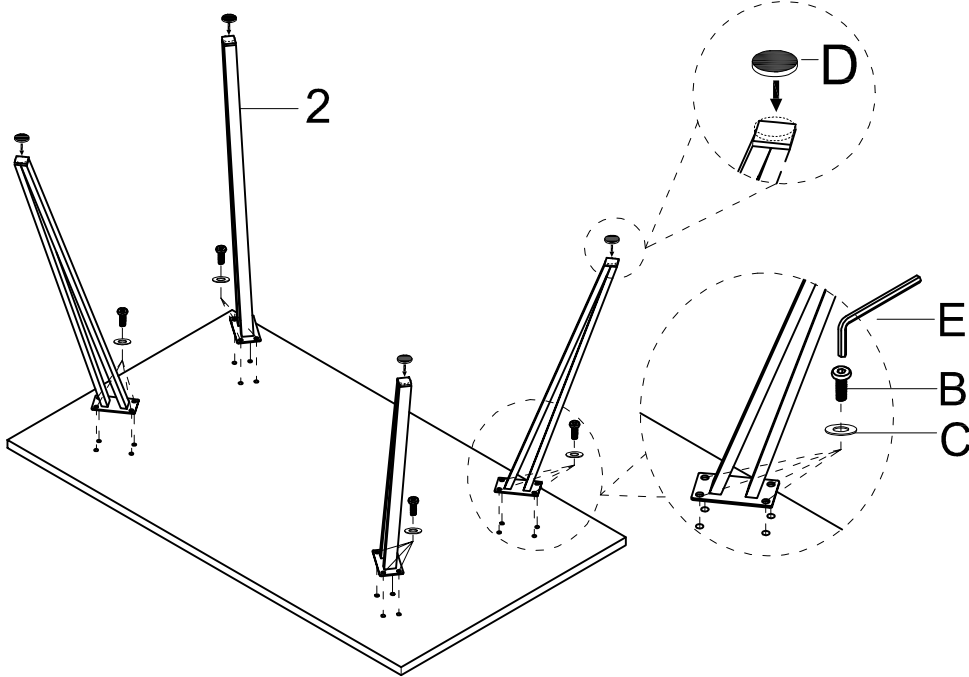

B

M8\*16  
16X

C

Ø18\*Ø8\*1.5  
16X

D

Ø25  
4X

E

5mm  
1X



3.

