

Mars

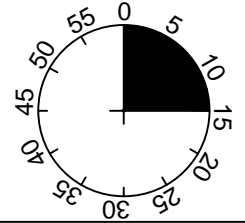

1

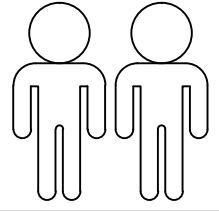
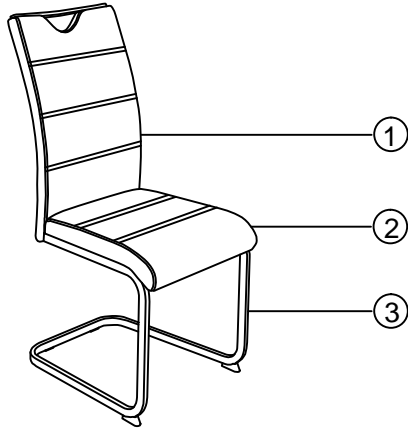
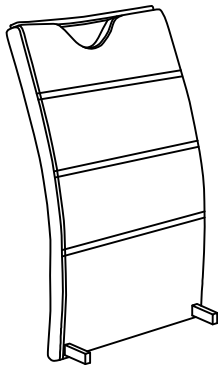

2

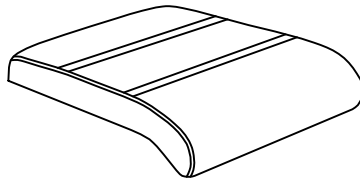

3

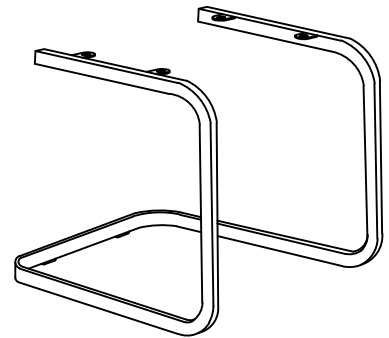

1	1x
2	1x
3	1x

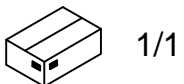

A	M6X20	B	M6X12	C	Ø18xØ6x1.5	D	4MM	E	M4x25	F	
	4x		4x		4x		1x		4x		2x

I.

1

E M4x25
4x

F
2x

100%

2

B M6x12
4x

D 4MM
1x

75%

3

A M6x20
4x

C Ø18xØ6x1.5
4x

D 4MM
1x

75%

4

D 4MM
1x

100%



**LE TRI
+ FACILE**



Séparez les éléments avant de trier