

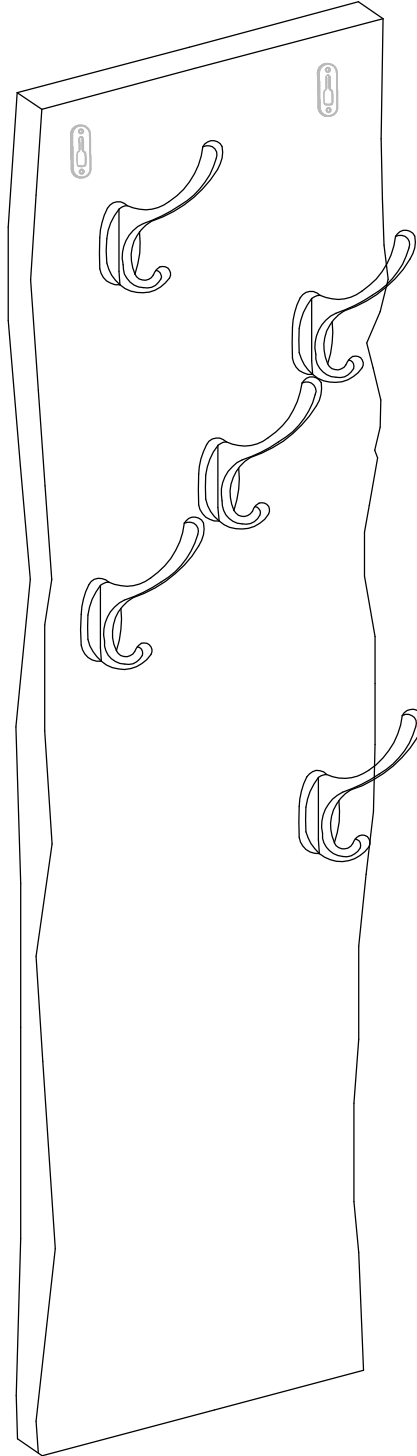

x1

9603 5357, 5162 5649

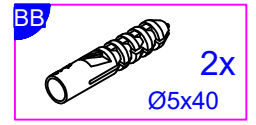
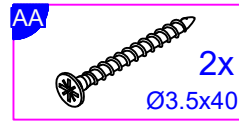
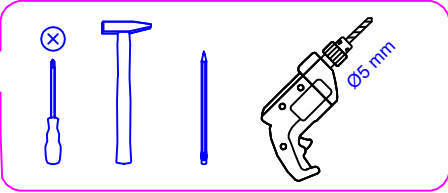
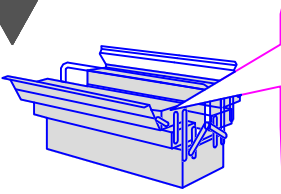
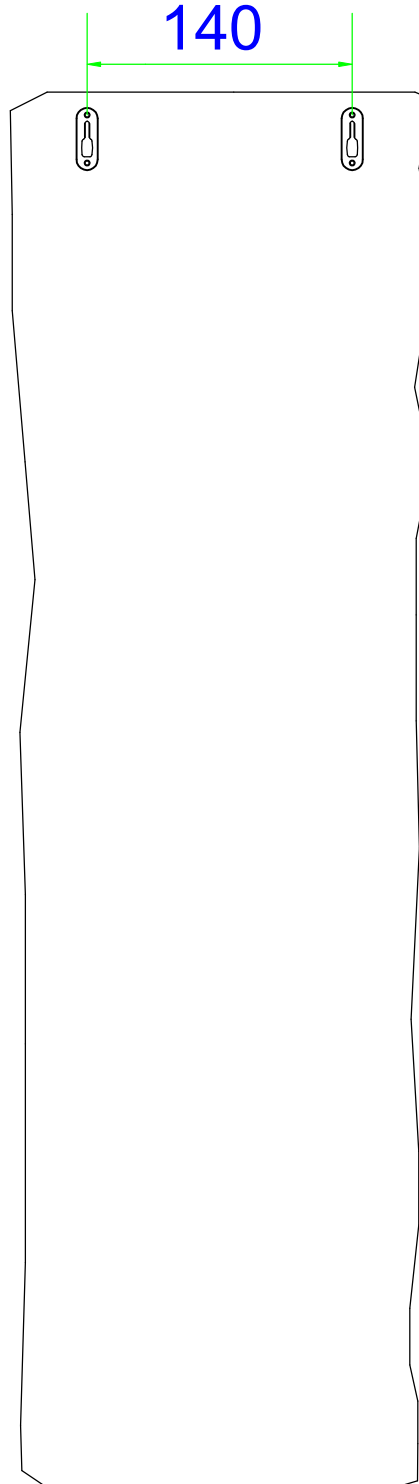

140



 Achtung • Attention • Attenzione Opgelet • Uwaga • Pozor • Figyelem Atenție • Dikkat • Внимание 	
(D)	Bei Einigen Wandtypen kann ein Spezialdübel erforderlich sein!
(GB)	For certain wall types, a special wall plug may be necessary!
(FR)	Pour certains types de murs il faut des chevilles spéciales!
(IT)	Per alcune strutture di parete può essere necessario un tassello speciale!
(NL)	Bij enkele muurtypen is een speciale plug misschien vereist.
(PL)	Do niektórych rodzajów ścian koniecznie zastosować specjalne kołki mocujące.
(CZ)	U některých typů stěn může být zapotřebí speciální hmoždinka!
(SK)	Upevnenie na stenu slúži ako ochrana proti prevráteniu- bezpodmienečne použite! Pre niektoré druhy stien môže byť potrebná špeciálna hmoždinka!
(HU)	Egyes faltípusoknál speciális tiplít kell használni!
(RO)	Pentru unele tipuri de pereți este posibil să fie necesar un diblu special!
(TR)	Bazı duvar tiplerinde bunun için özel bir dubel gerekli olabilir!
(RU)	Для некоторых типов стен может потребоваться специальный дюбель!

1

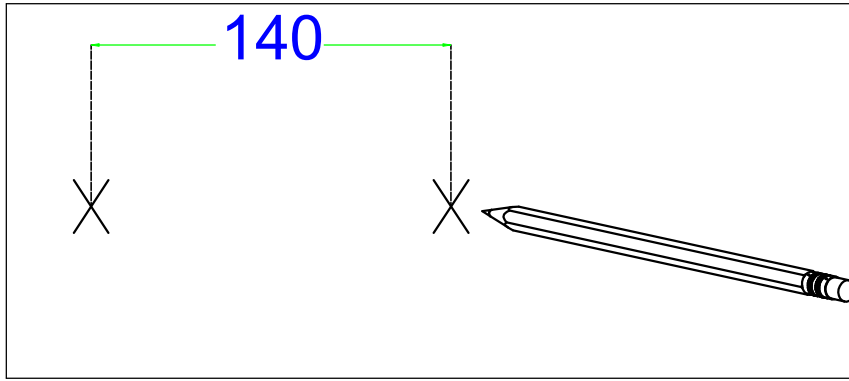

2

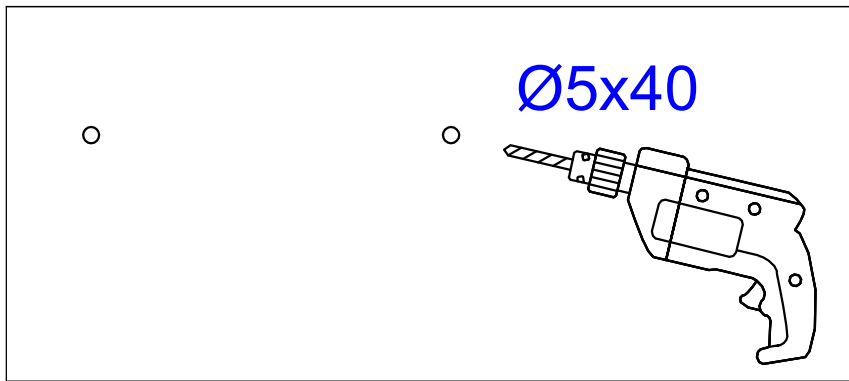

3

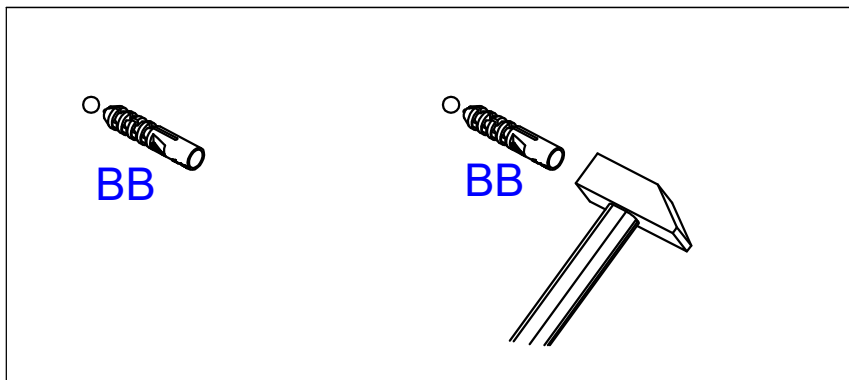

4

