

Sofia

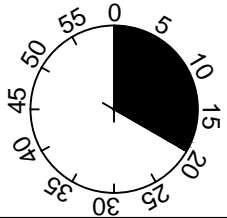

1

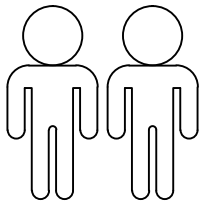

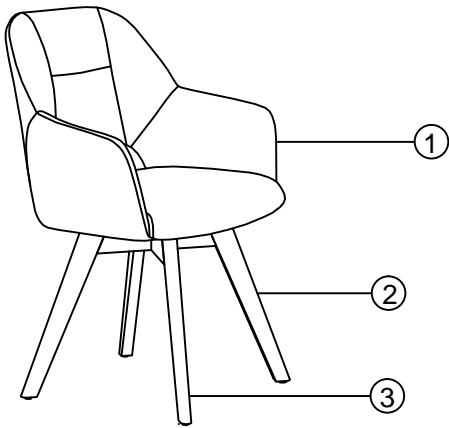

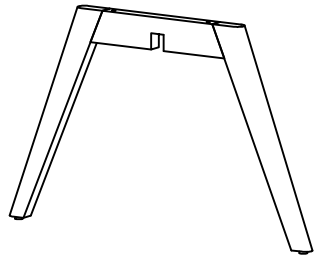
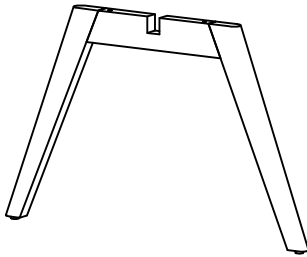
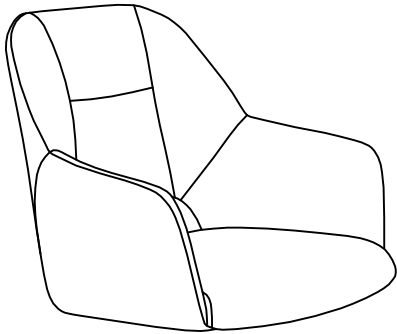

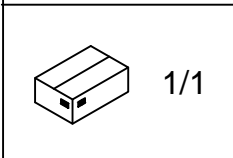

2

3



1	1 x
2	1 x
3	1 x





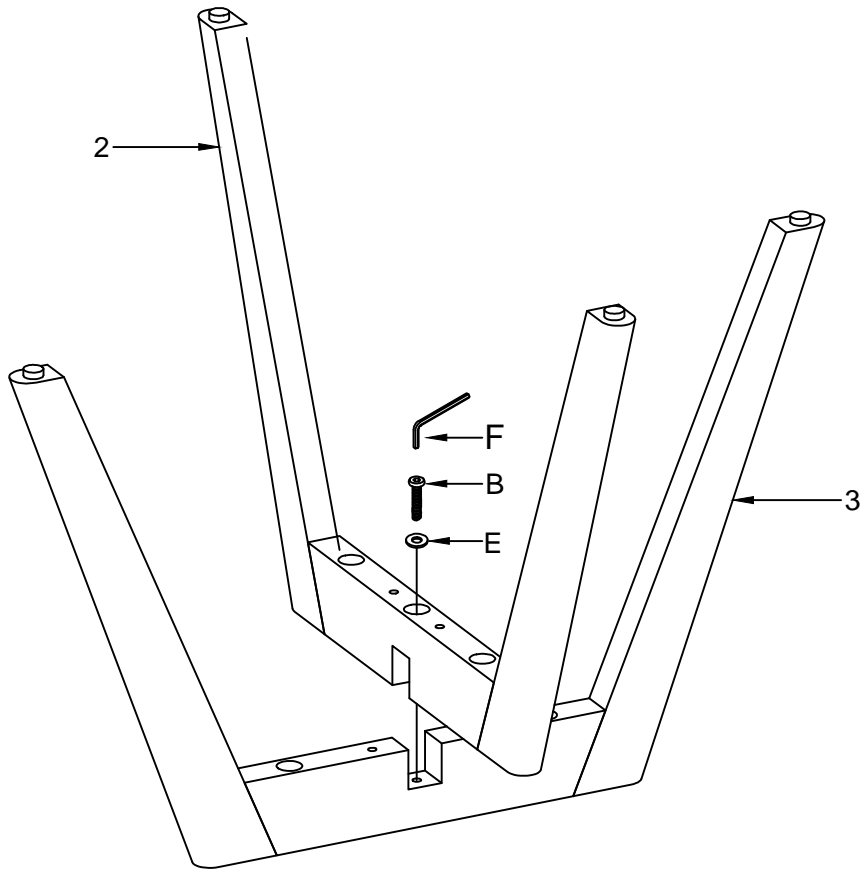

A	M6X16	B	M6x45	C	M6x55	D	M6x60	E	Ø16xØ6x1.5	F	5MM
	4x		1x		2x		2x		5x		1x
G	Ø18xØ8x10	H	T3.0x85x85								
	2x		1x								

I.

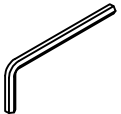

1

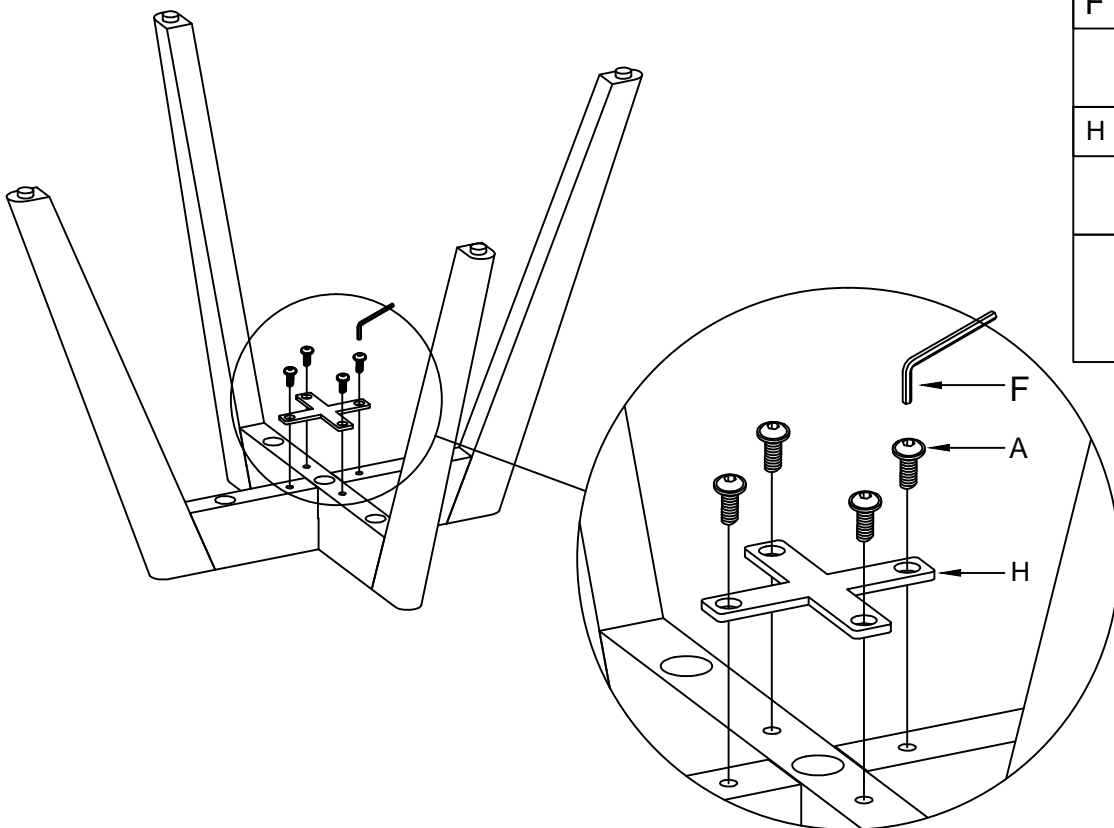

B	M6x45
	
	1x
E	Ø16xØ6x1.5
	
	1x
F	5MM
	
	1x
	

2

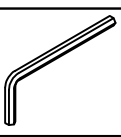
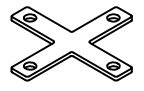

A	M6X16
	
	4x
F	5MM
	
	1x
H	T3.0X85X85
	
	1x
	

II.

3

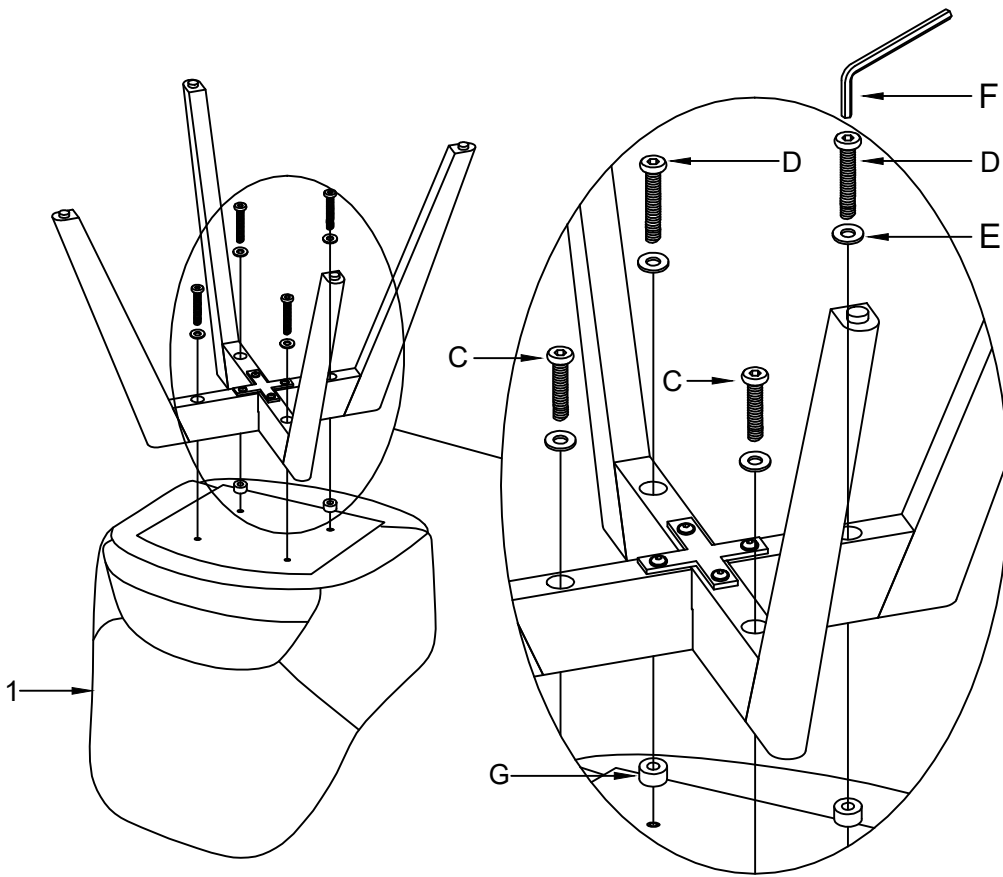

C	M6x55
	2x
D	M6x60
	2x
E	Ø16xØ6x1.5
	4x
F	5MM
	1x
G	Ø18xØ8x10
	2x

4

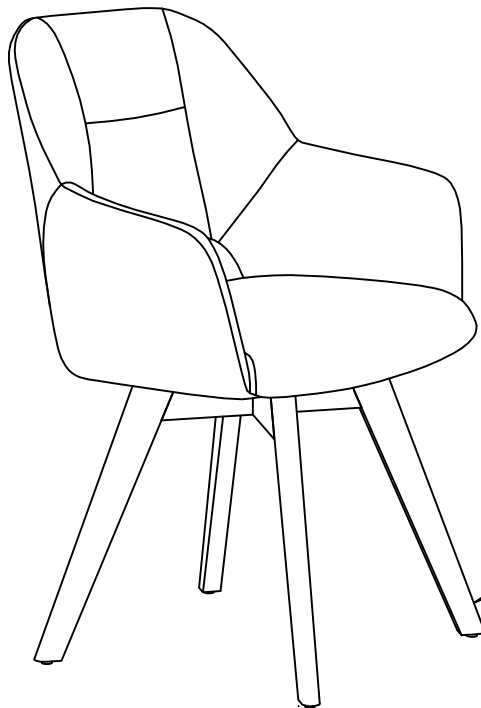

F	5MM
	1x



**LE TRI
+ FACILE**



Séparez les éléments avant de trier