

- (D) AUFBAUANLEITUNG
- (NL) HANDLEIDING VOOR DE MONTAGE
- (TR) MONTAJ TALIMATI
- (RO) INSTRUCIUNI DE ASAMBLARE
- (F) INSTRUCTION D'ASSEMBLAGE
- (CZ) POKYNY K MONTÁŽI
- (BG) ИНСТРУКЦИИ ЗА МОНТАЖ
- (HR) NAPUTCI ZA MONTAŽU
- (E) INSTRUCCIONES DE MONTAJE

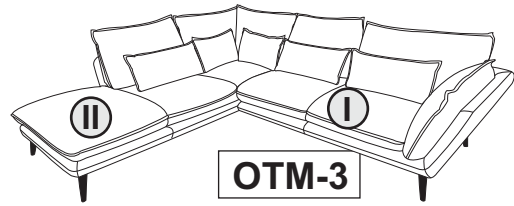

- (GB) ASSEMBLY INSTRUCTIONS
- (PL) INSTRUKCJA MONTAŻU
- (RU) Инструкция по монтажу
- (I) PROCEDURA DI ASSEMBLAGGIO
- (SK) POKYNY K MONTÁŽI
- (HU) OSSZESZERELESI UTMUTATO
- (SLO) ASSEMBLY INSTRUCTIONS
- (S) MONTERINGSANVISNING
- (LT) DIEGIMO INSTRUKCIJOS

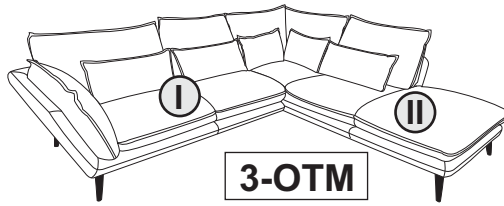

"MARA"

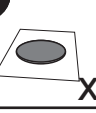
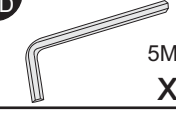
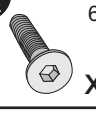

1/3

 A	H180  B	H170  C	 D 5MM x1	 E 6X30 x18	pre-assembled pre assemble vormontiert premontato wstępnie zamontowane
--	--	--	--	--	--

hardware bag/ sachet materiel/ zubehorbeutel/ sacchetti materiale/ bolsa de materiales/ worek materialowy

①

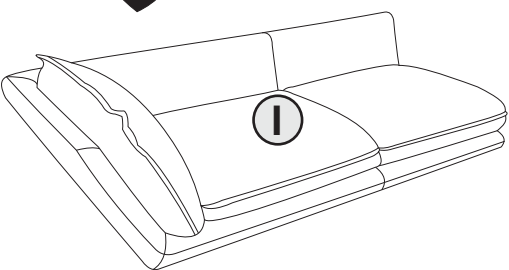

0
10
20
30
40
50
60
70
80

②

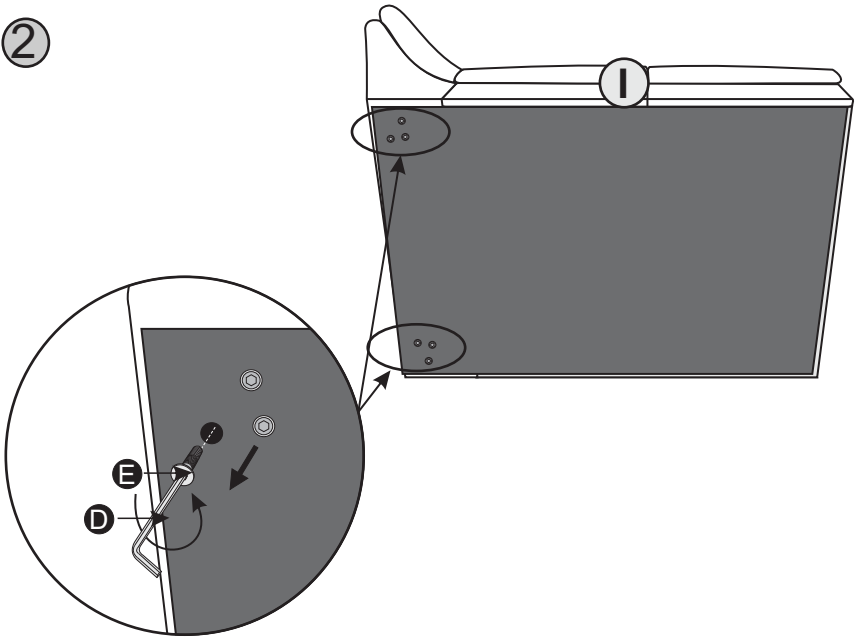
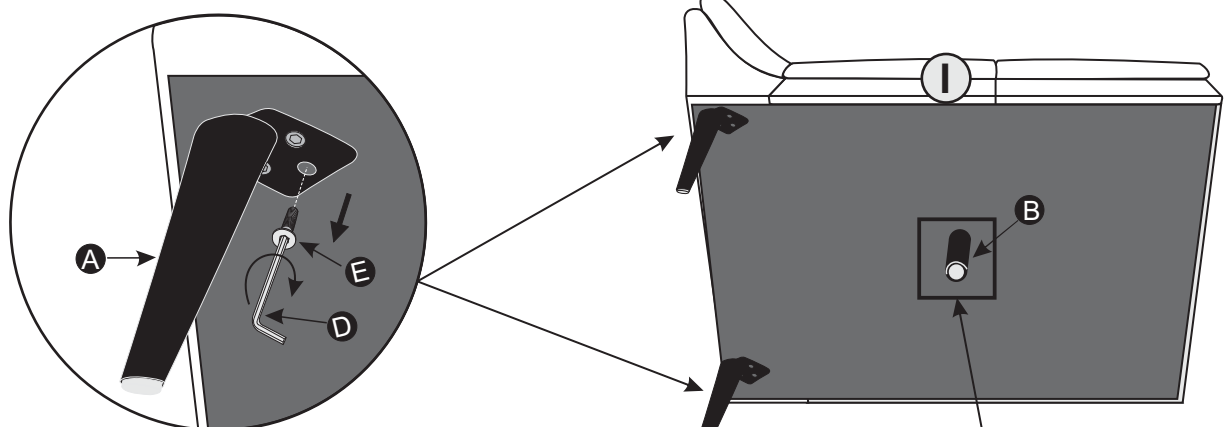
90
100
110
120
130
140
150
160
170
180



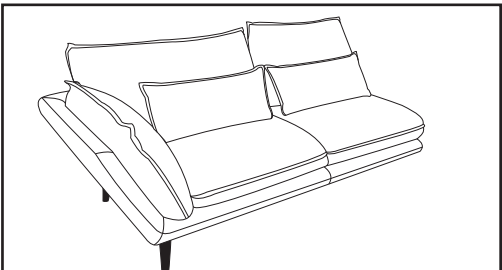

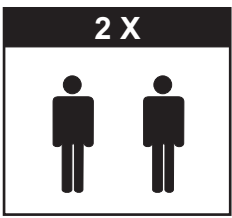

- (D) AUFBAUANLEITUNG
- (NL) HANDLEIDING VOOR DE MONTAGE
- (TR) MONTAJ TALIMATI
- (RO) INSTRUCIUNI DE ASAMBLARE
- (F) INSTRUCTION D'ASSEMBLAGE
- (CZ) POKYNY K MONTÁŽI
- (BG) ИНСТРУКЦИИ ЗА МОНТАЖ
- (HR) NAPUTCI ZA MONTAŽU
- (E) INSTRUCCIONES DE MONTAJE

- (GB) ASSEMBLY INSTRUCTIONS
- (PL) INSTRUKCJA MONTAŻU
- (RU) Инструкция по монтажу
- (I) PROCEDURA DI ASSEMBLAGGIO
- (SK) POKYNY K MONTÁŽI
- (HU) OSSZESZERELESI UTMUTATO
- (SLO) ASSEMBLY INSTRUCTIONS
- (S) MONTERINGSANVISNING
- (LT) DIEGIMO INSTRUKCIJOS

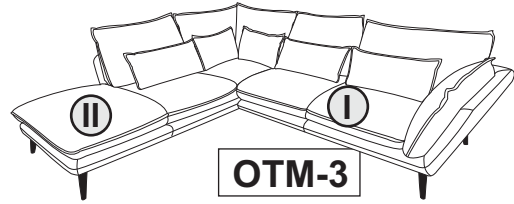
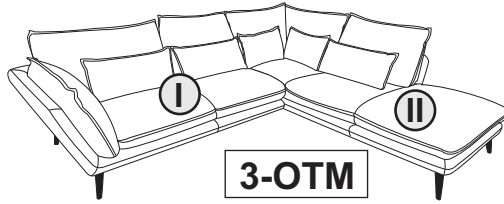

“MARA”



2/3



H180

x6

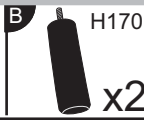

H170

x2

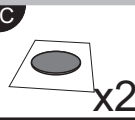

x2

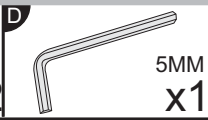

5MM
x1

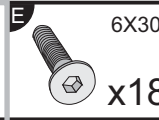

6X30

x18

pre-assembled
pre assemble
vormontiert
premontato
wstępnie
zamontowane

hardware bag/ sachet matériel/ zubehorbeutel/ sacchetti materiale/ bolsa de materiales/ worek materiałowy

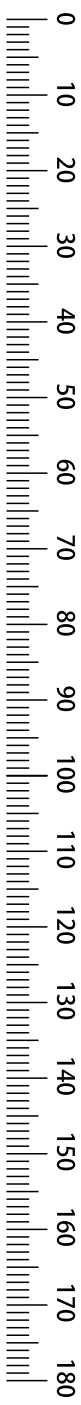

①

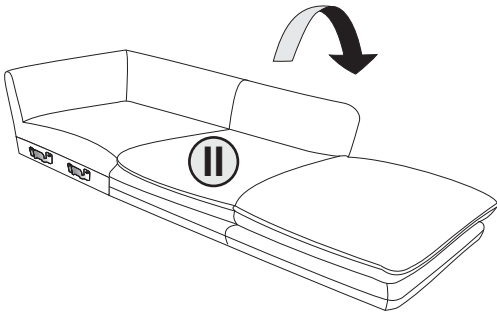
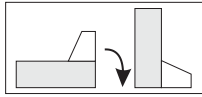

②

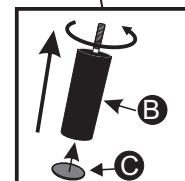
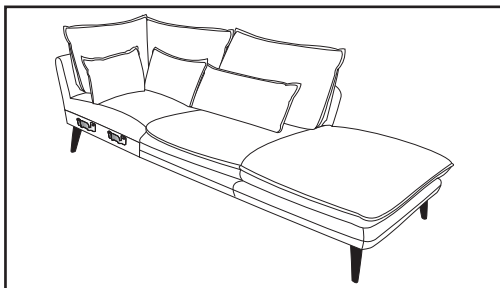
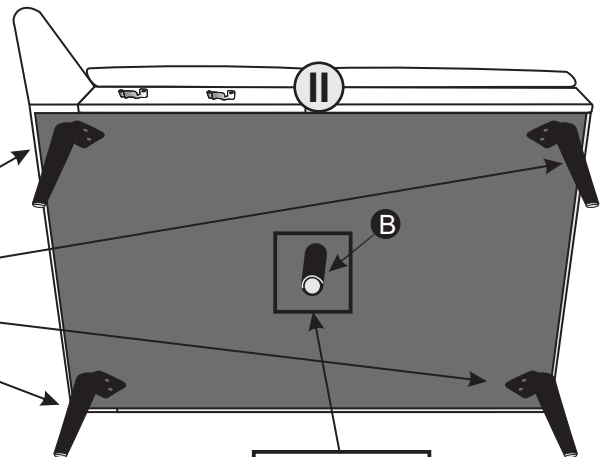
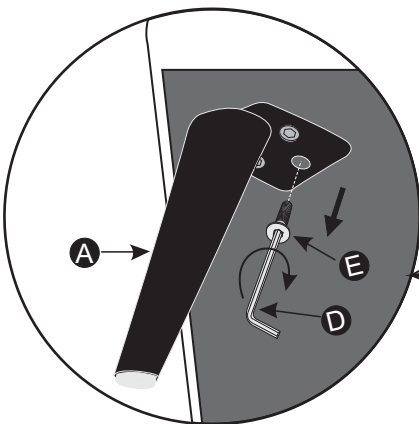
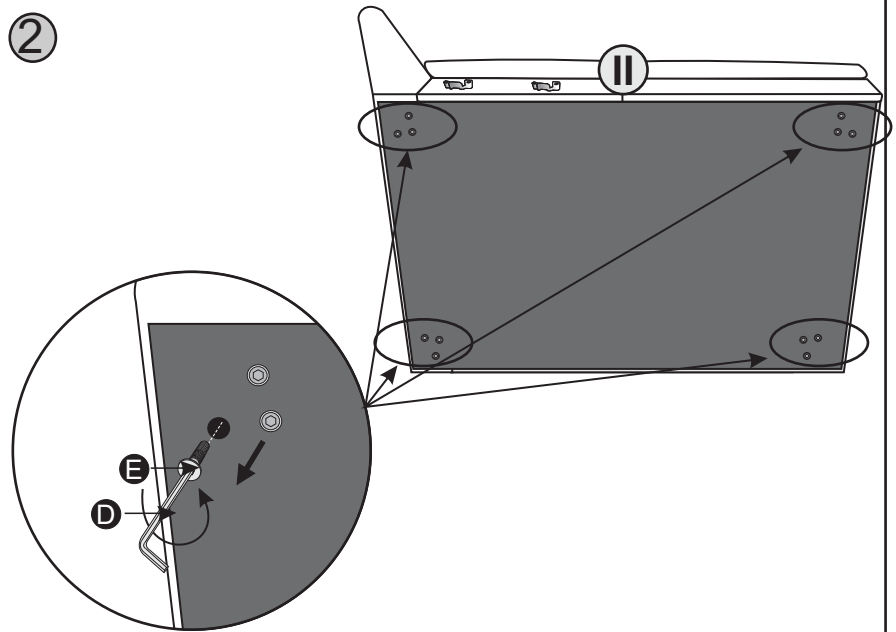



- | | |
|----------------------------------|-------------------------------|
| (D) AUFBAUANLEITUNG | (GB) ASSEMBLY INSTRUCTIONS |
| (NL) HANDLEIDING VOOR DE MONTAGE | (PL) INSTRUKCJA MONTAŻU |
| (TR) MONTAJ TALIMATI | (RU) Инструкция по монтажу |
| (RO) INSTRUCȚIUNI DE ASAMBLARE | (I) PROCEDURA DI ASSEMBLAGGIO |
| (F) INSTRUCTION D'ASSEMBLAGE | (SK) POKYNY K MONTÁŽI |
| (CZ) POKYNY K MONTÁŽI | (HU) OSSZESZERELESI UTMUTATO |
| (BG) ИНСТРУКЦИИ ЗА МОНТАЖ | (SLO) ASSEMBLY INSTRUCTIONS |
| (HR) NAPUTCI ZA MONTAŽU | (S) MONTERINGSANVISNING |
| (E) INSTRUCCIONES DE MONTAJE | (LT) DIEGIMO INSTRUKCIJOS |



“MARA”

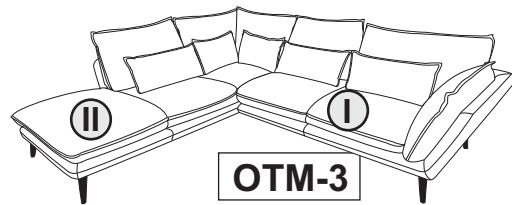
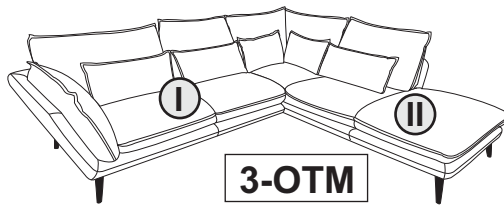

3/3

0
10
20
30
40
50
60
70
80
90
100
110
120
130
140
150
160
170
180

