

1.

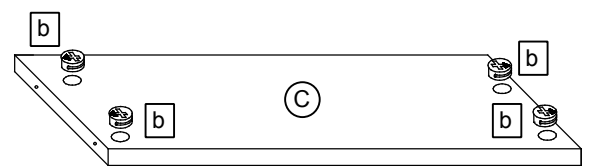

2.

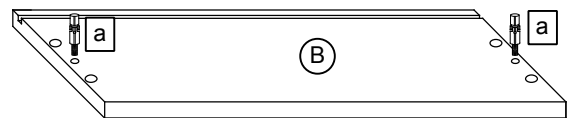
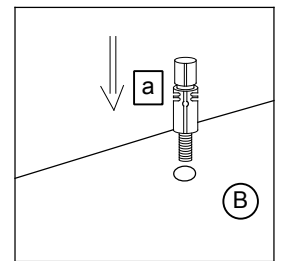
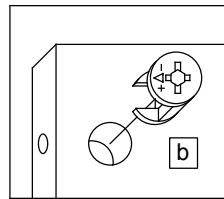
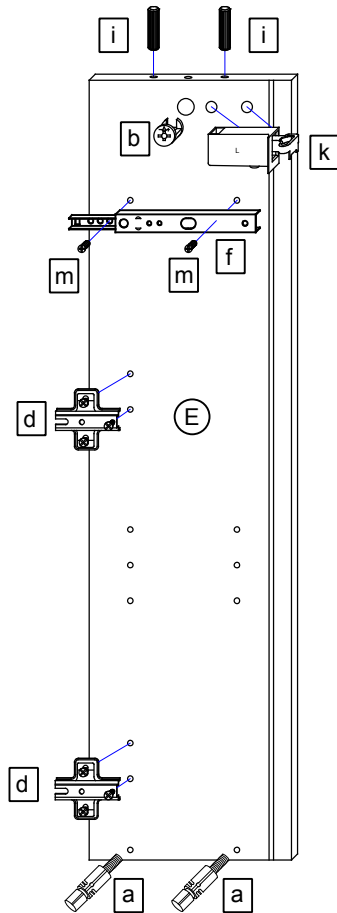
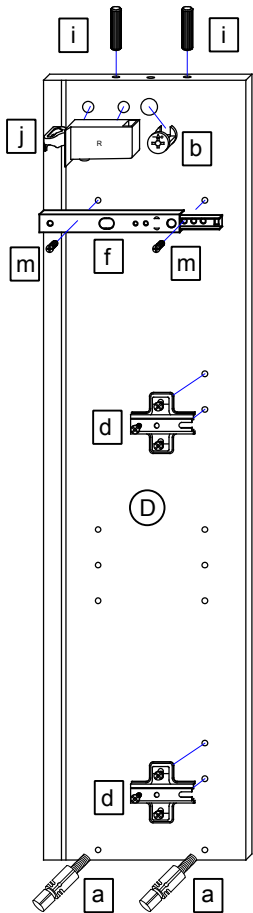
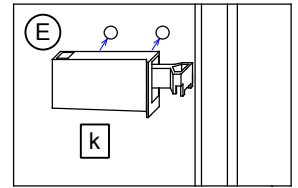
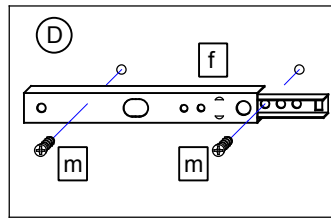
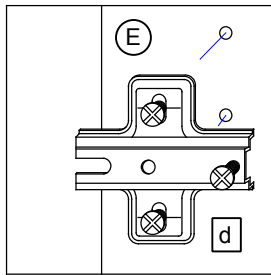
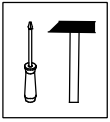
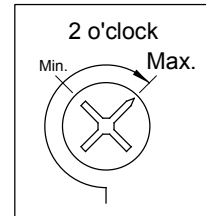
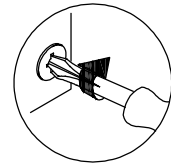
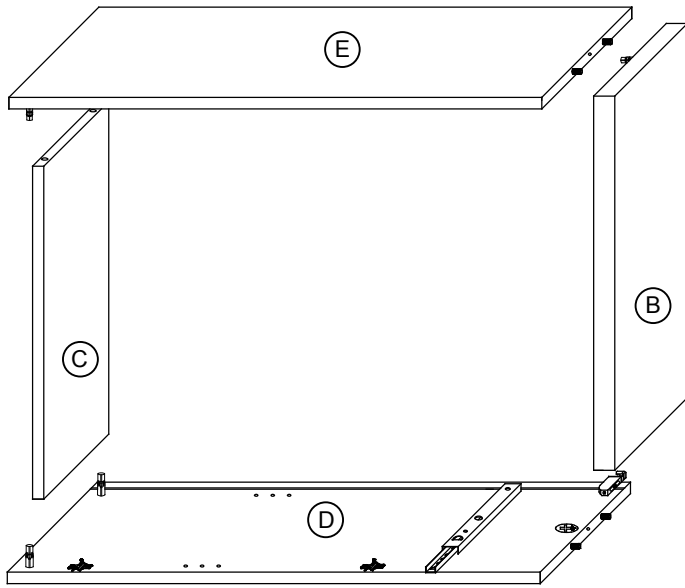
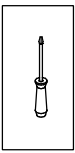

3.

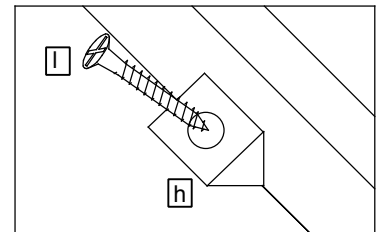
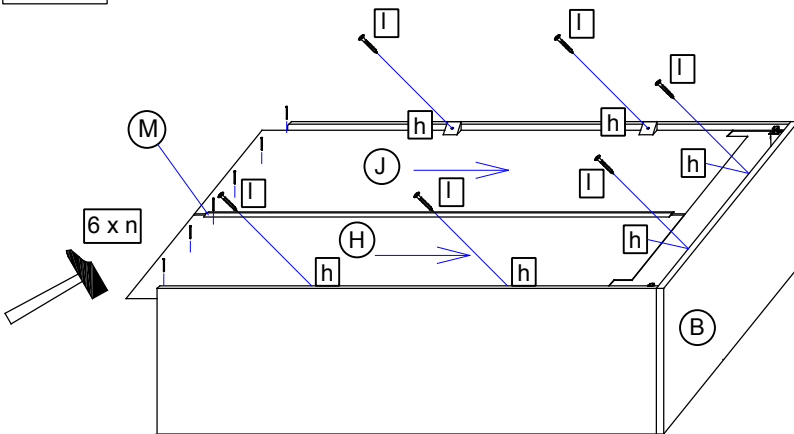
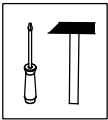

4.

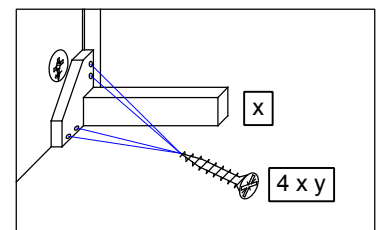
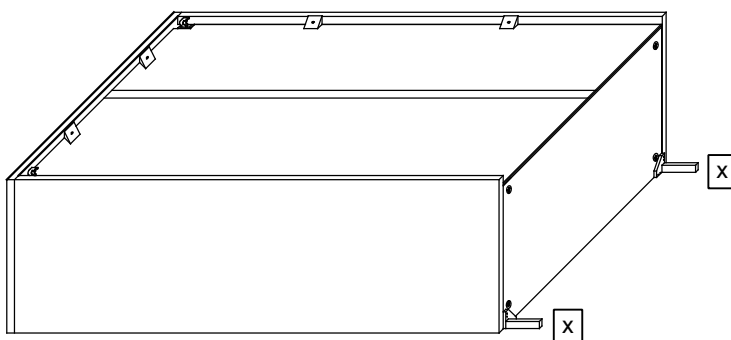
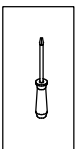

5.

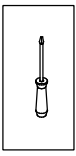

T6 Die Schrankaufhänger dienen zur Kippsicherung des Schrankes und müssen grundsätzlich montiert werden.

T9 Lassen Sie den Schrank nur durch fachkundige Personen mit für die Wand geeignetem Montagematerialien montieren.

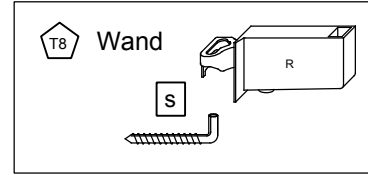
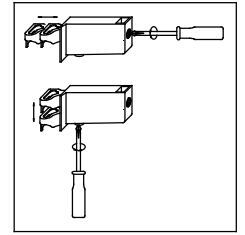
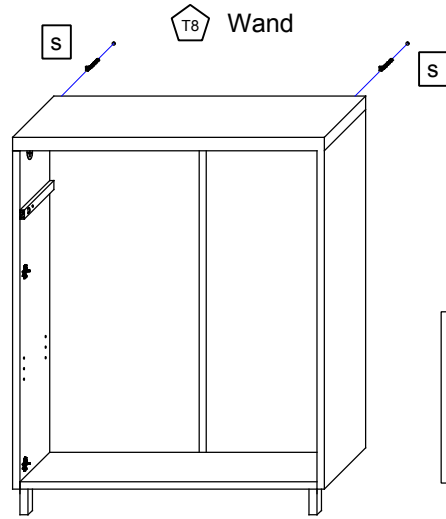

6.

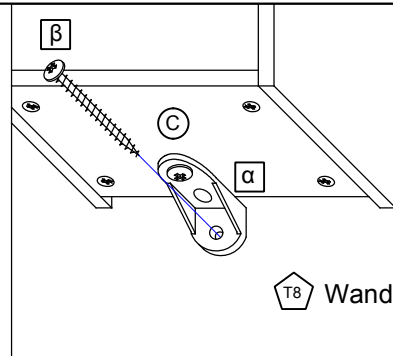
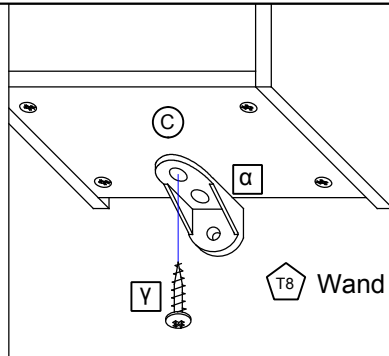
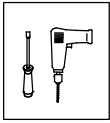

7.

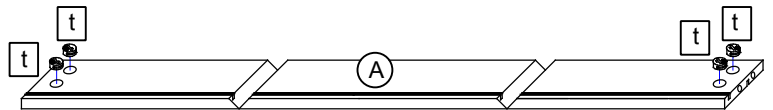
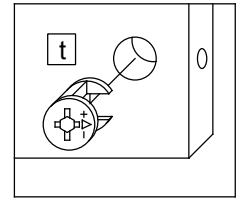
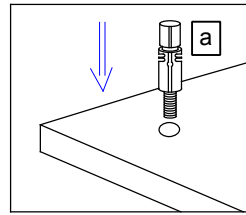
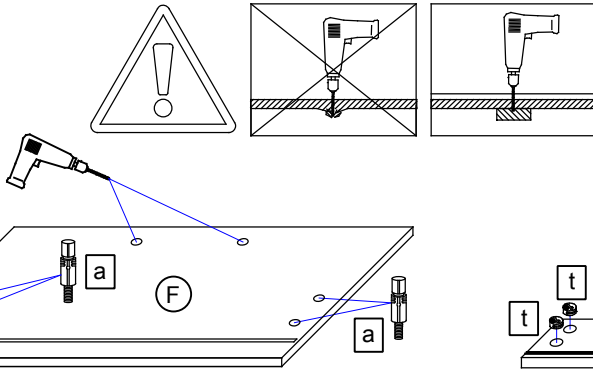
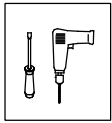

8.

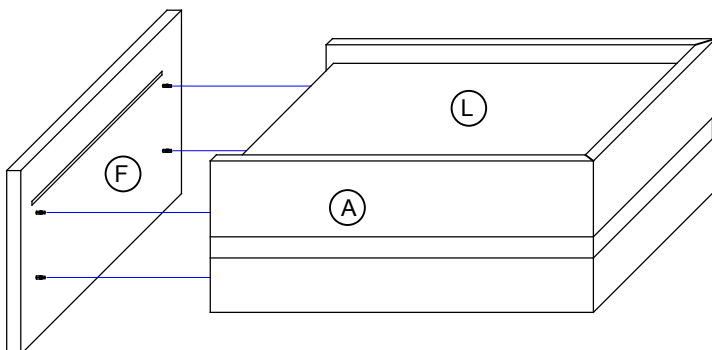
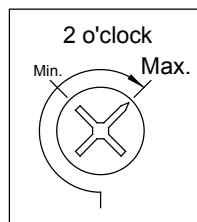
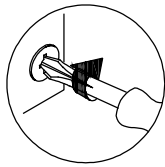
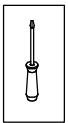

9.

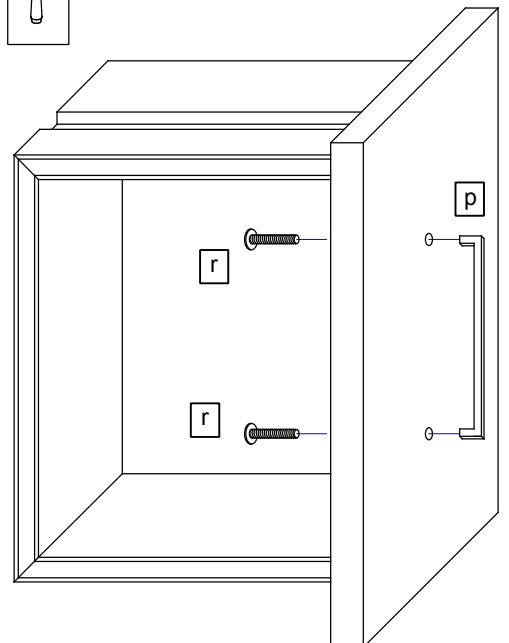
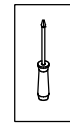

10.

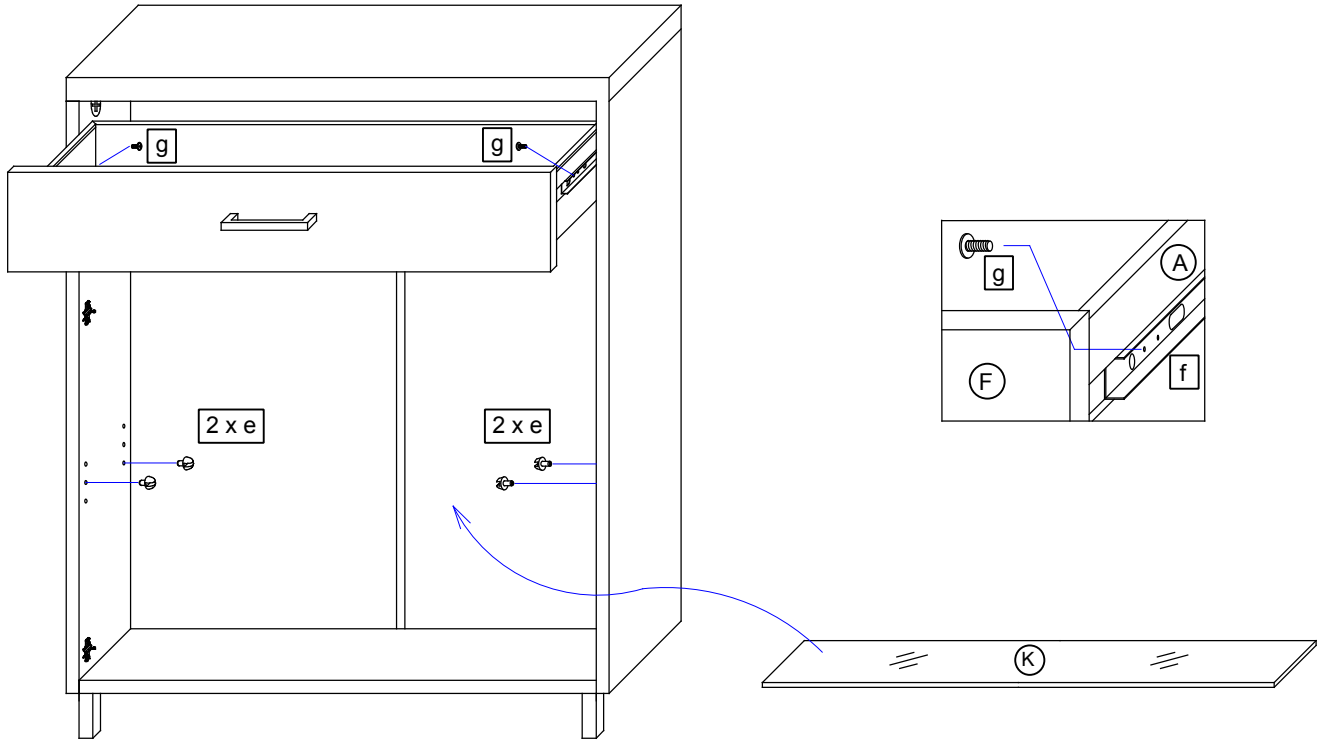

11.

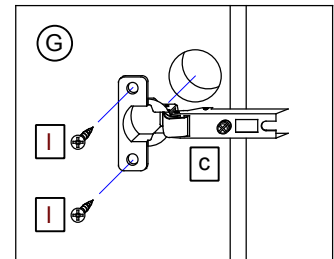
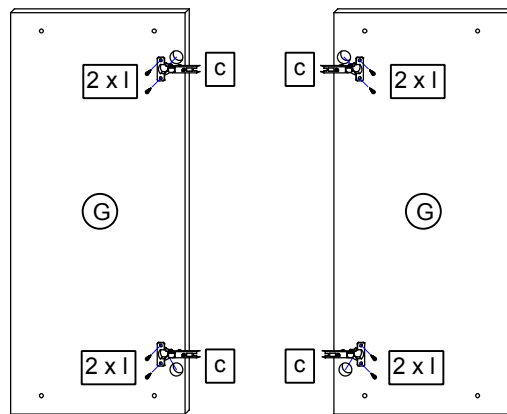
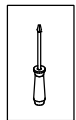

12.

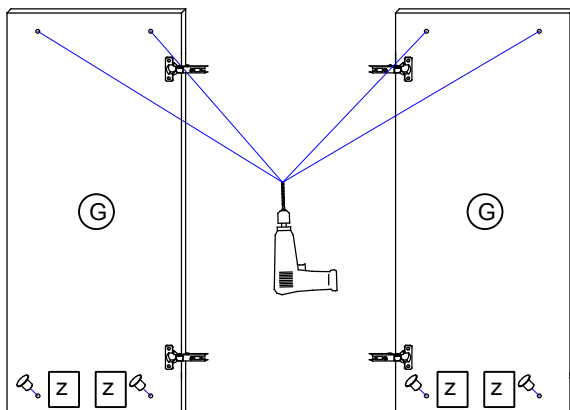
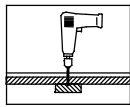
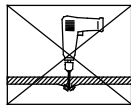

13.

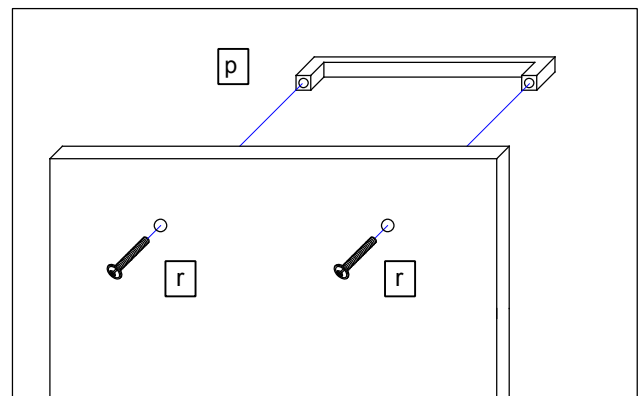
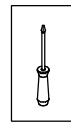

14.

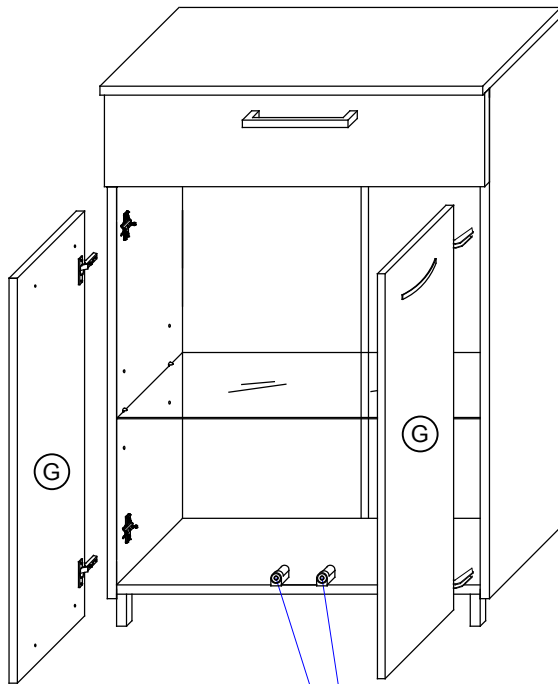
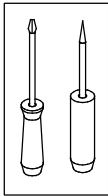

T11 Bei Türmontage das Scharnier einhängen, bis Anschlag öffnen und anschließend festschrauben.

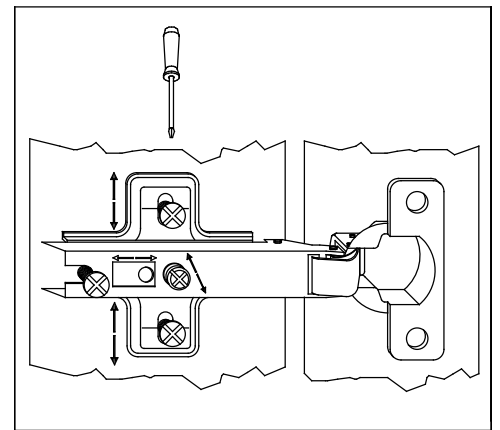
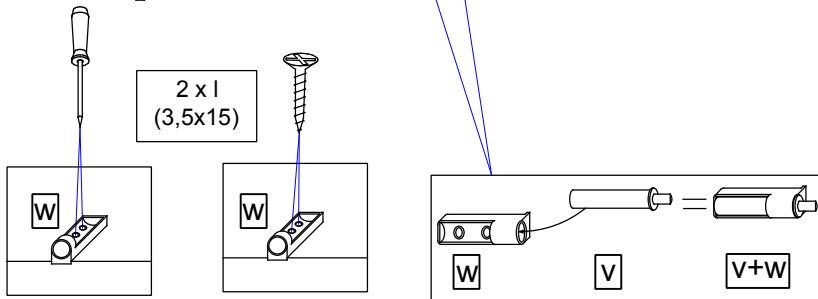
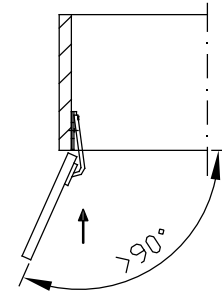

15.

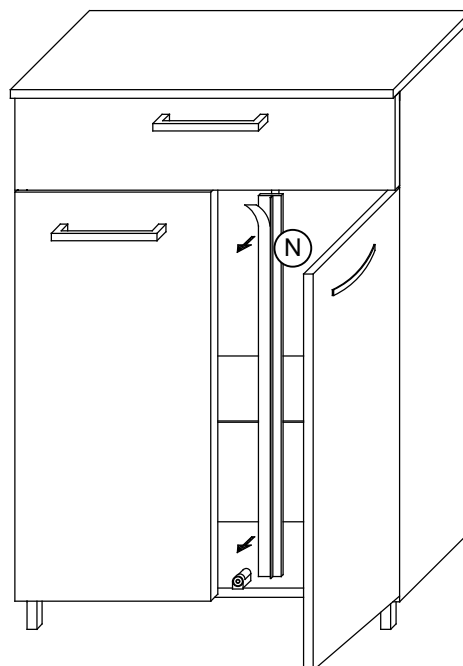

T12 Das Möbel bitte nur mit einem feuchten Tuch reinigen.