

Art.Nr.: 7104 8303, 2839 0820, 6889 1160, 4220 2806, 3993 4826,
7124 7651

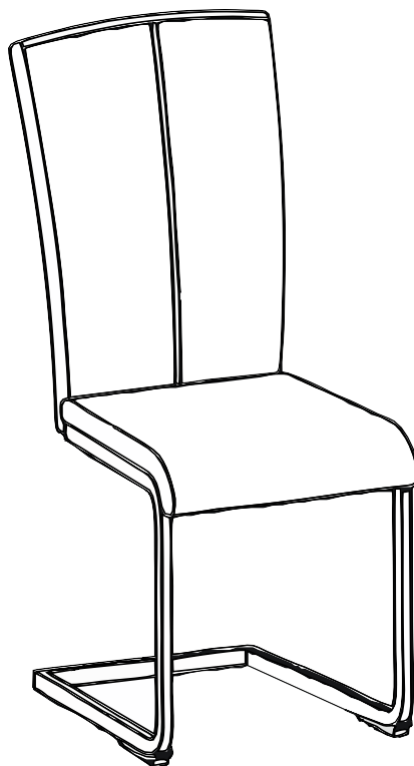

- | | | | |
|-----------|------------------------------------|-----------|--------------------------------|
| D | Montageanleitung | GB | Assembly instructions |
| FR | Notice de montage | IT | Istruzioni di montaggio |
| NL | Handleiding voor de montage | PL | Instrukcja montażu |
| CZ | Montážní návod | SK | Návod na montáž |
| HU | Szerelési útmutató | RO | Instrucțiuni de montaj |
| TR | Montaj talimatı | RU | Инструкция по монтажу |

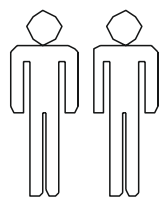

LKZ040779

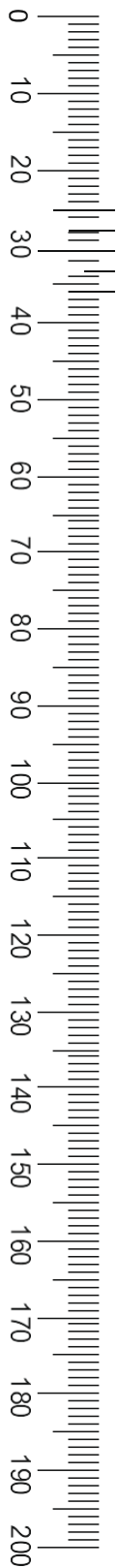

Service . Assistenza . Dienstverlening . Serwis Servis . Szerviz

Name.Nom.Nome.Naam.
Nazwa.Jmeno.Nazov.Nev
Denumire.Isim

ALEX

Nr.No.N.Homep.Č.Sz
5577 8346, 9310 7906, 7862 7848, 4190 4628,
2933 5761, 3536 4147, 8949 9146, 4722 3218,
2303 6535

Typ . Type . Tip . Tipus . Tipo

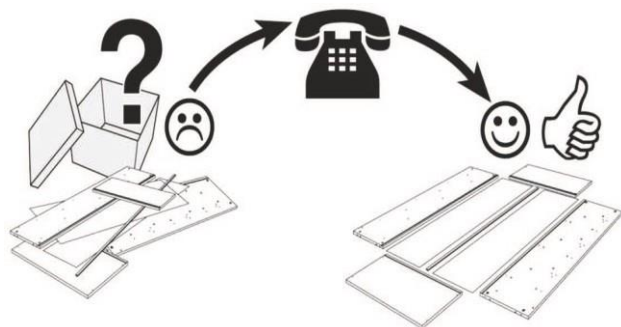
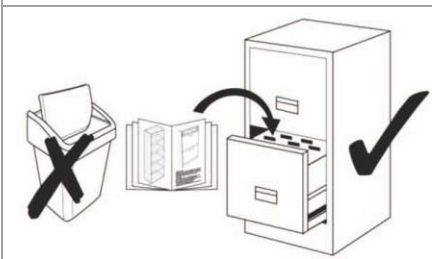

A 1PC	B 1PC	C 1PC	D M6 × 5mm 8PCS	E 4PCS
F 4mm 1PC	G 2PCS	H 2PCS	I M5X 6 2PCS	

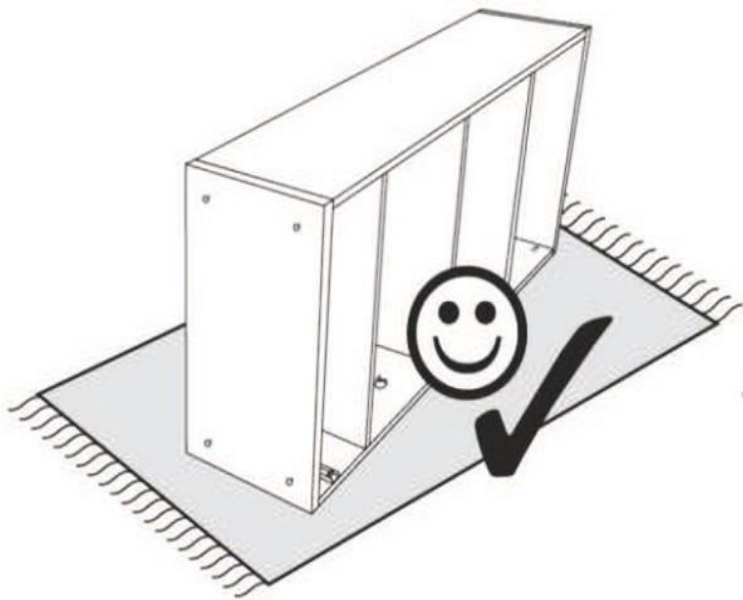

1

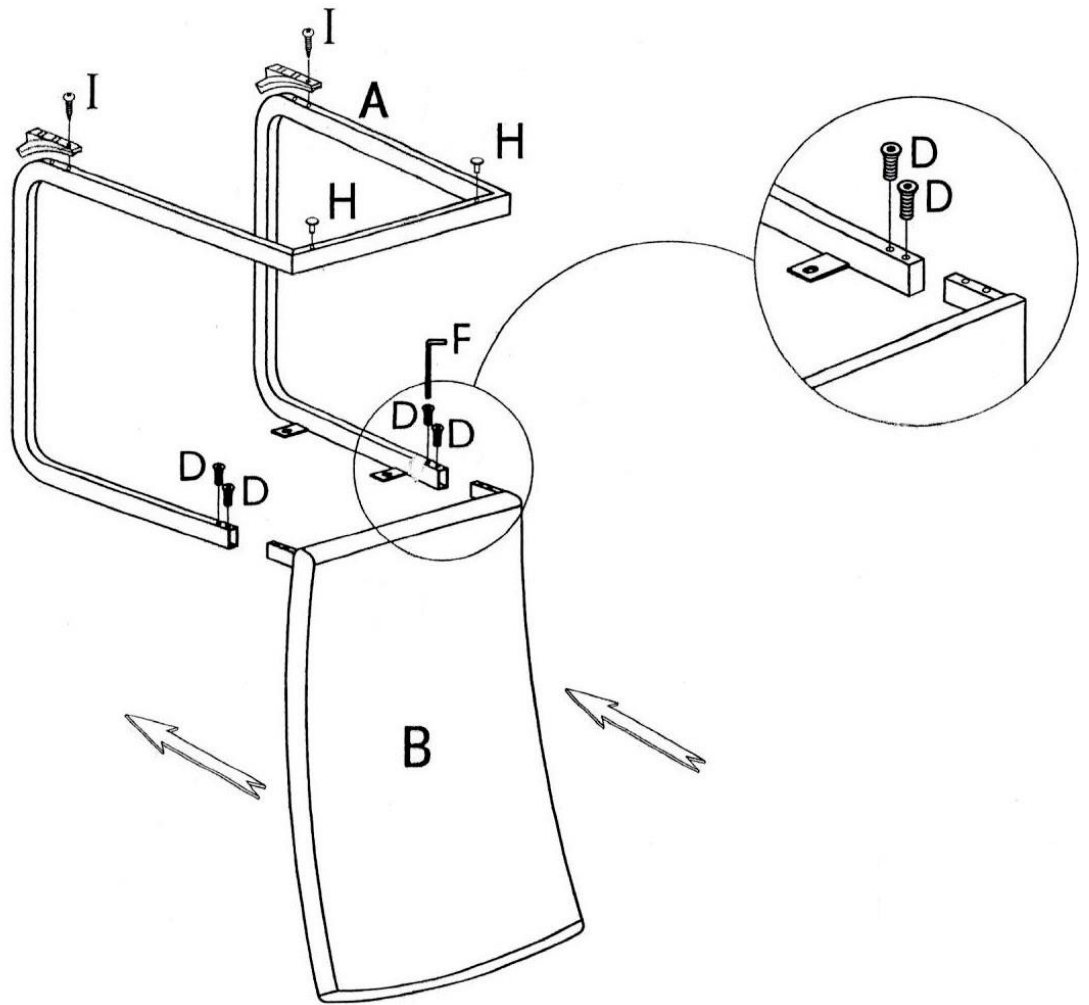
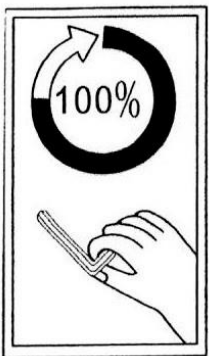

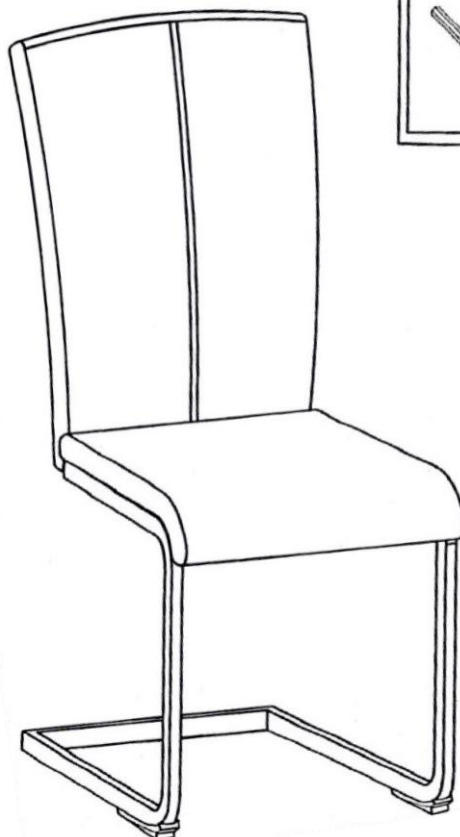
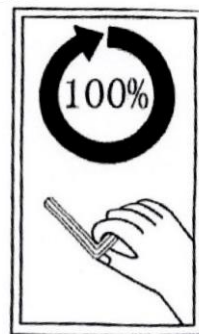
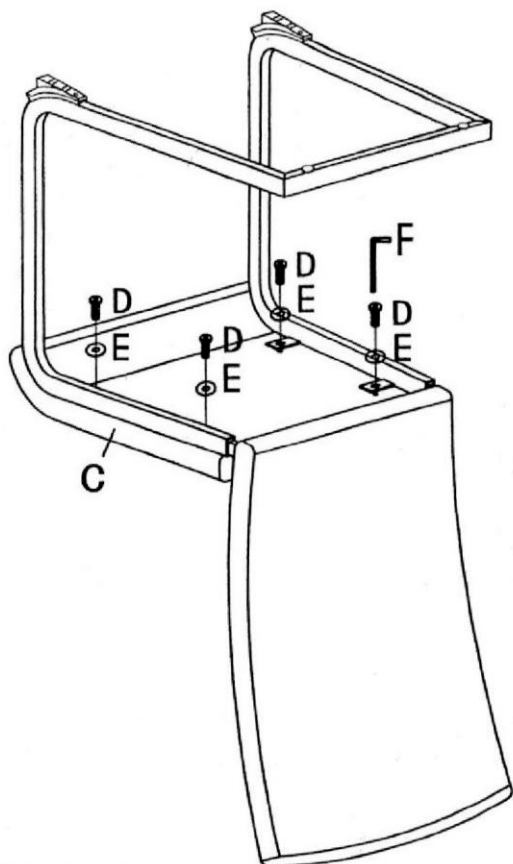
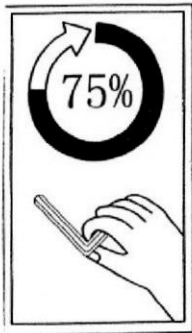

D Allgemeiner Sicherheitshinweis:

Nicht mehr benötigte Verpackungs-Materialien und Kleinteile von Kindern fernhalten!

GB General safety instructions:

Package material you do not need any more take far away from children.

F Consigne de sécurité:

Ecarter les matériaux d'emballage et petites pièces inutiles de la portée des enfants.

PL Ogólne zasady bezpieczeñstwa:

Nie potrzebne opakowania i małe części chronić przed dziećmi!

RU Общие указания по безопасности:

Неиспользуемые упаковочные материалы и мелкие детали следует хранить в недоступном для детей месте!

NL Algemene veiligheidsinstructie:

Verpakkingsmaterialen die u niet meer nodig heeft en kleine onderdelen uit de buurt van kinderen houden!

TR Genel güvenli̇lik uyarısı:

Kullanılmayan ambalaj malzemeleri ve küçük parçaları çocuklardan uzak tutun!

RO Indicație generală de siguranță:

Ambalajele care nu mai sunt necesare și piesele de mici dimensiuni nu vor fi lăsate la îndemâna copiilor!

IT Indicazioni generali per la sicurezza:

Tenere lontano da bambini materiali di imballaggio non più necessari e minuterie!

SK Všeobecné bezpečnostné upozornenie:

Nepotrebný baliaci materiál a malé diely uchovávajte mimo dosahu detí!

CZ Všeobecné bezpečnostní upozornění:

Obalové materiály a malé díly, které už nepotřebujete, udržte mimo dosah dětí!

HU Általános biztonsági tudnivaló:

Ha már nincs szüksége a csomagolóanyagokra és apró darabokra, tegye őket olyan helyre, ahol nem férhetnek hozzá gyermekek!