

PUCCINI/PUCCI

2501-0058/5031/3300-0037
3100-0037/5032/2503-0058

F/B

171106

- | | | | |
|-----------|--|-----------|---|
| D | MONTAGEANLEITUNG
BEDIENUNGSANLEITUNG | GB | ASSEMBLY INSTRUCTIONS
INSTRUCTION MANUAL |
| NL | HANDLEIDING VOOR DE MONTAGE
GEBRUIKSAANWIJZING | PL | INSTRUKCJA MONTAŻU
INSTRUKCJA OBSŁUGI |
| TR | MONTAJ TALIMATI
KULLANIM KLAVUZU | RU | ИНСТРУКЦИЯ ПО МОНТАЖУ
ИНСТРУКЦИЯ ПО ЭКСПЛУАТАЦИИ |
| RO | INSTRUCȚIUNI DE INSTALARE
INSTRUCȚIUNI DE UTILIZARE | IT | ISTRUZIONI DI MONTAGGIO
MANUALE DI ISTRUZIONI |
| FR | NOTICE DE MONTAGE
MANUEL INSTRUCTIONS | SK | MONTÁŽNY NÁVOD
NÁVOD NA POUŽITIE |
| HU | KÖZGYŰLÉS UTASÍTÁSOK
KEZELÉSI UTASÍTÁS | CZ | MONTÁŽNÍ NÁVOD
NÁVOD K POUŽITÍ |
| SI | NAVODILA ZA MONTAŽO
NAVODILA ZA UPORABO | PT | INSTRUÇÕES DE MONTAGEM
MANUAL DO USUÁRIO |
| ES | INSTRUCCIONES DE MONTAJE
MANUAL DEL USUARIO | HR | UPUTE ZA MONTAŽU
UPUTE ZA UPOTREBU |

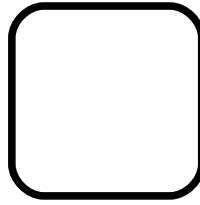
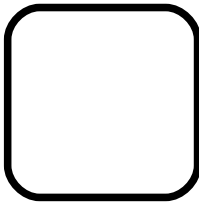

0019

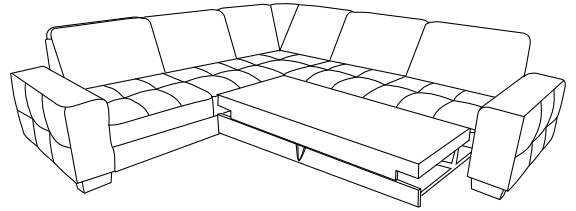
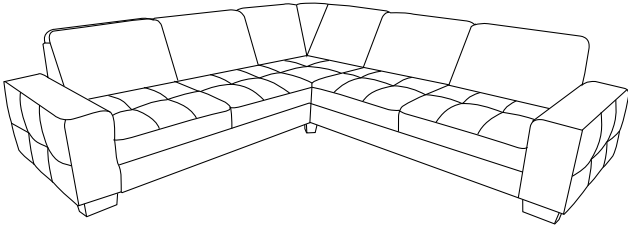

0019

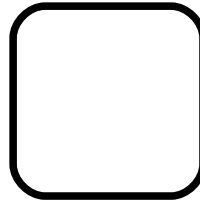
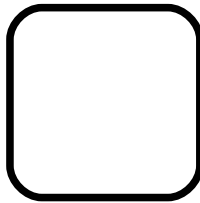

0058

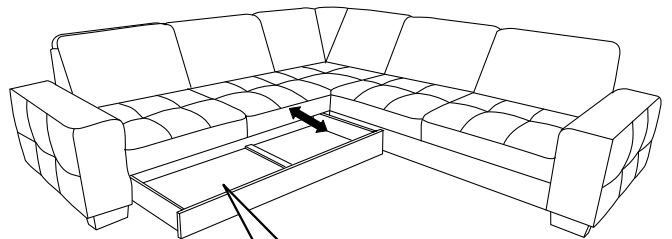
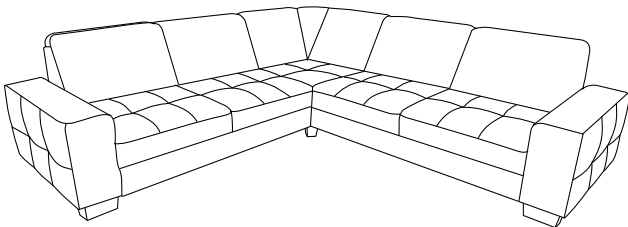

0058



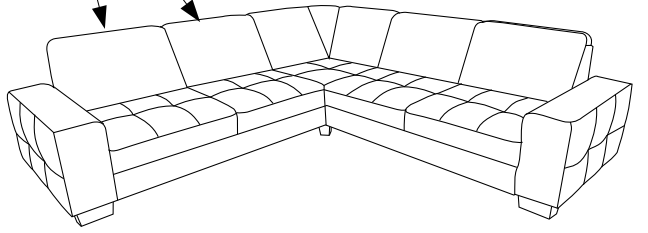
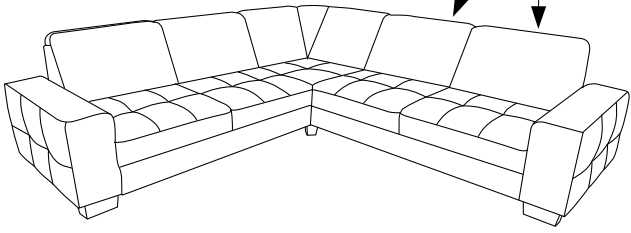





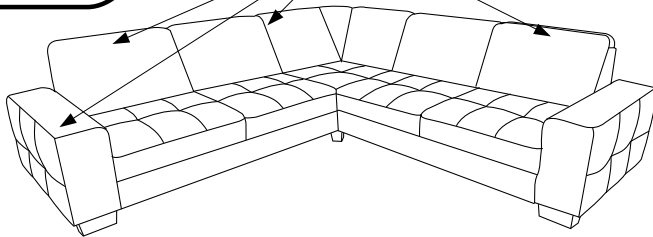
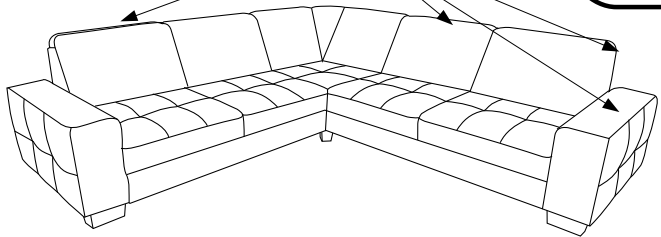



L

R

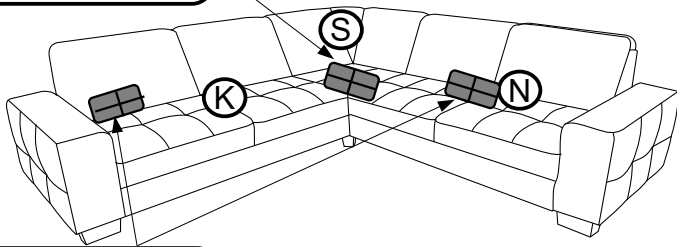
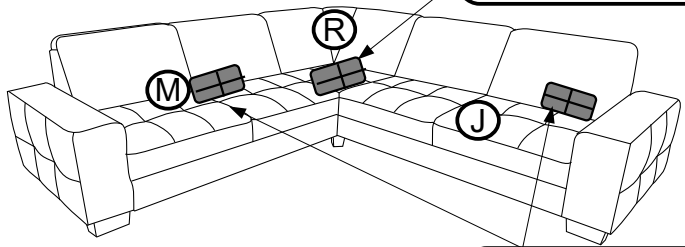

i L-5  X1	f H-90  X4	q M8*80  X4	x Fi-50 [mm]  X4
---	--	---	---





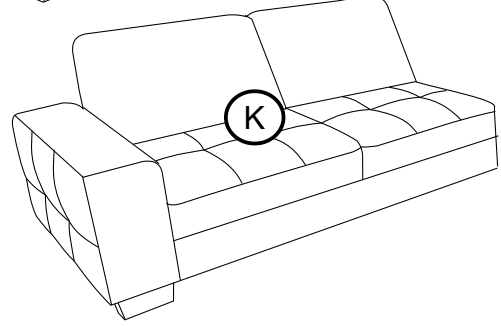
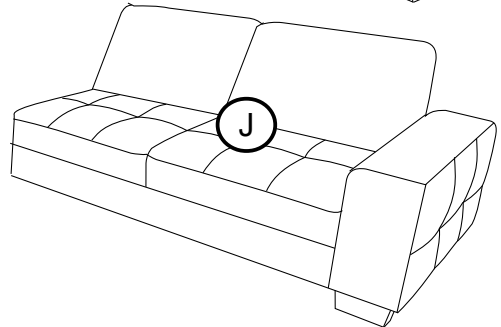
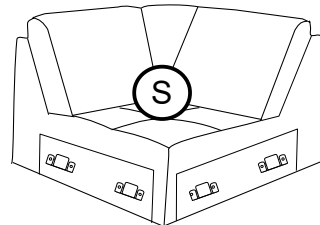
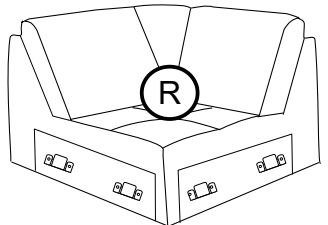
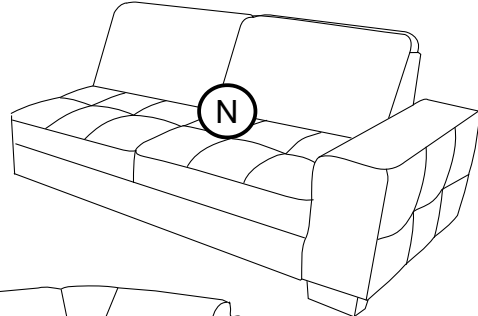
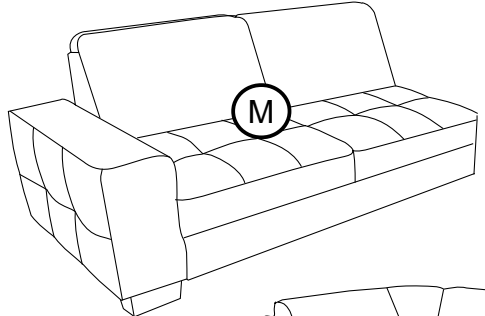

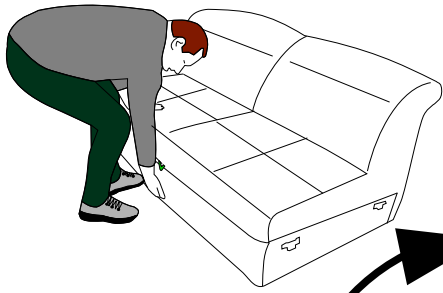
i L-5  X1	x Fi-50  X4	s H-90  X2	q M8*80  X4
---	---	--	--









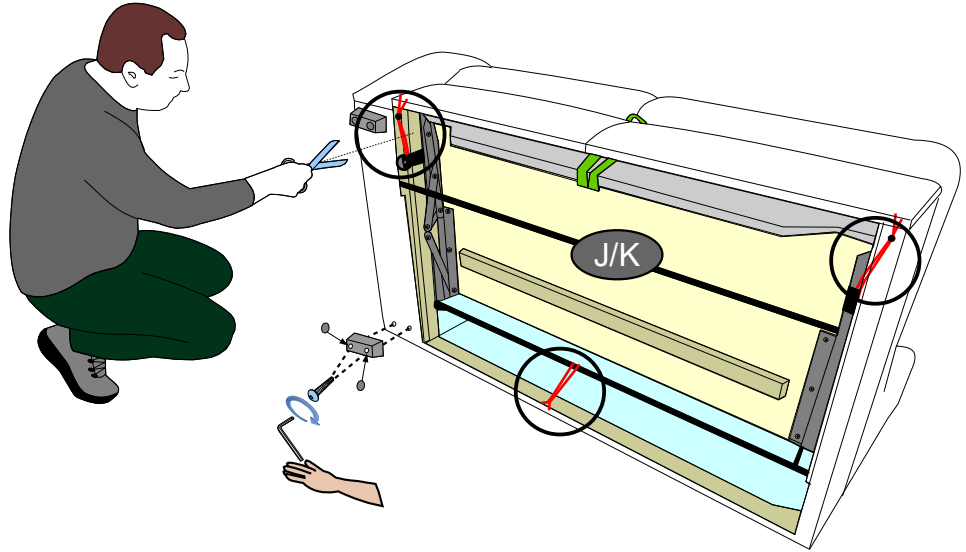



90°

X Fi- 50 	S H- 90 	q M8*80 	i L- 5 
X4	X2	X4	X1

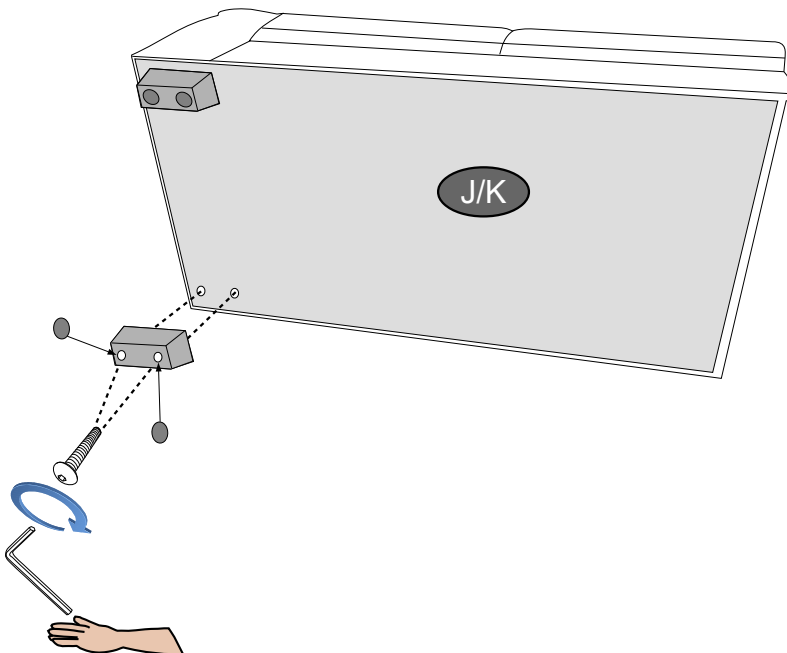





X Fi- 50 	S H- 90 	q M8*80 	i L- 5 
X4	X2	X4	X1

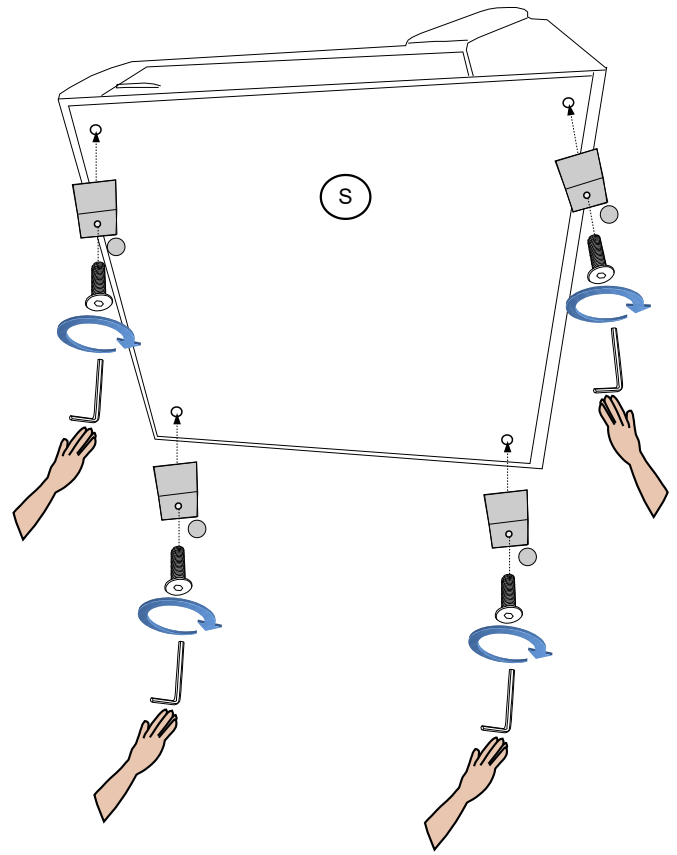
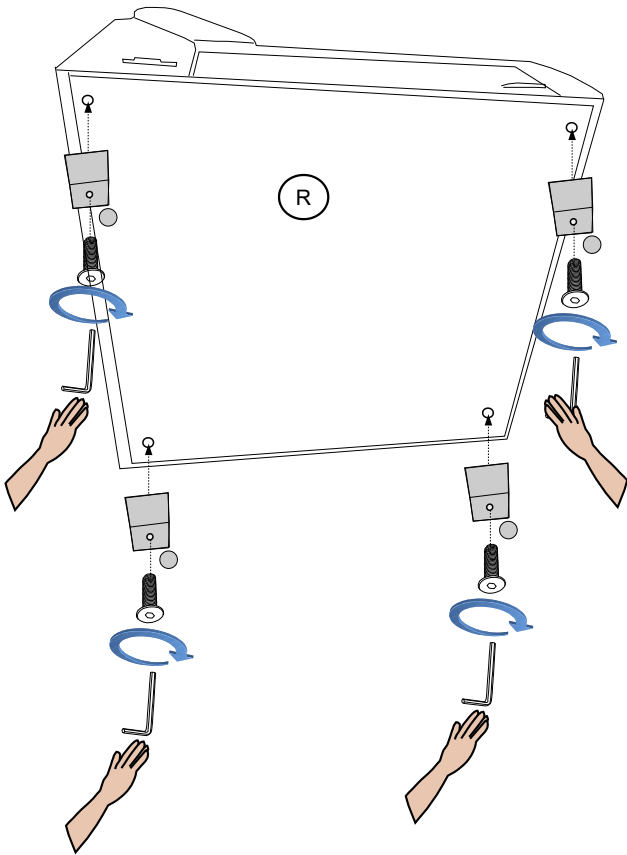

f H-90 	q M8*80 	x Fi-50 	i L-5 
X4	X4	X4	X1



x Fi-50 	s H-90 	q M8*80 	i L-5 
X4	X2	X4	X1

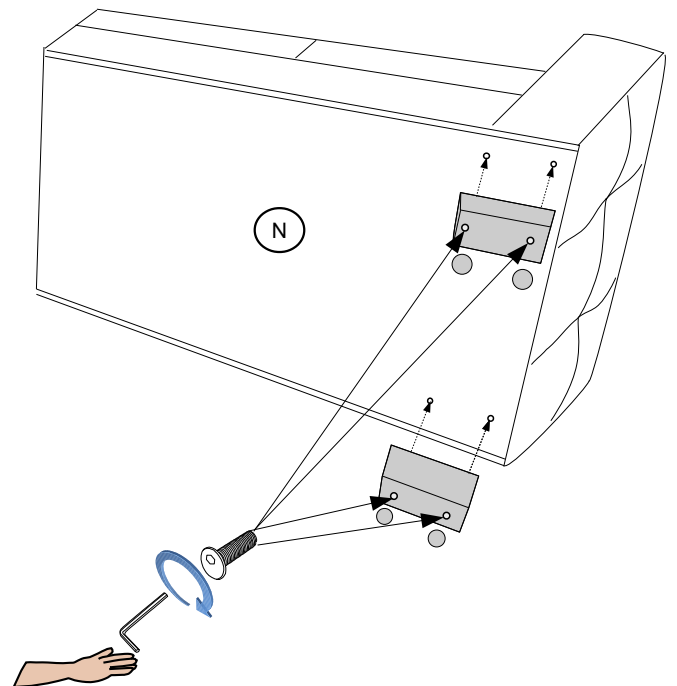
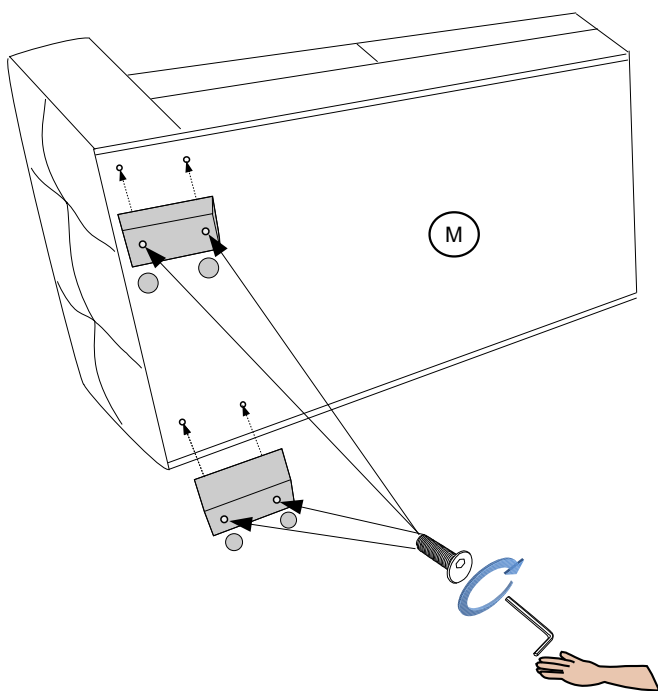

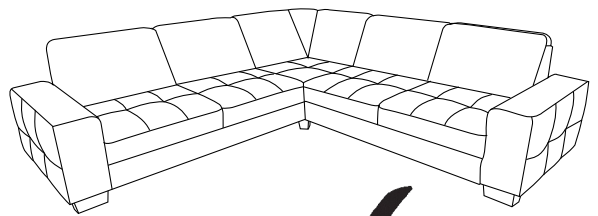
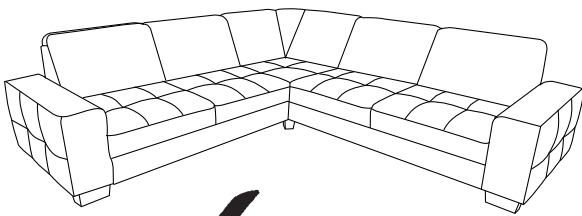
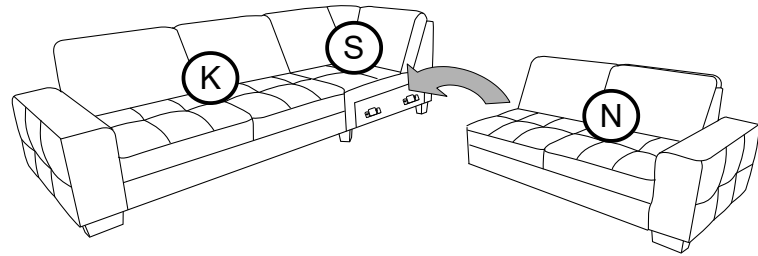
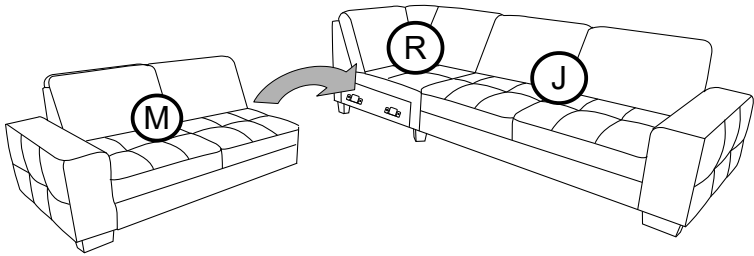
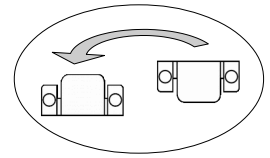
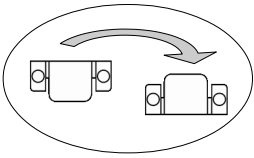
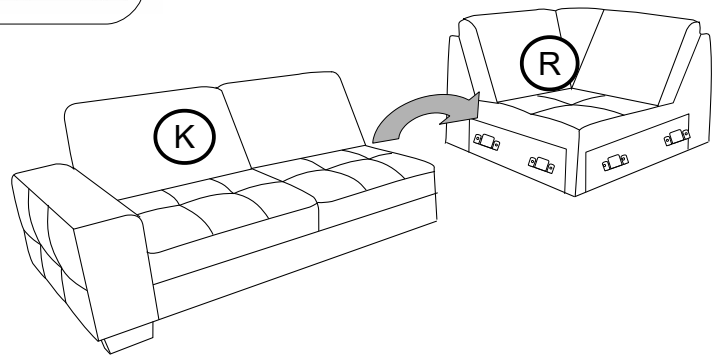
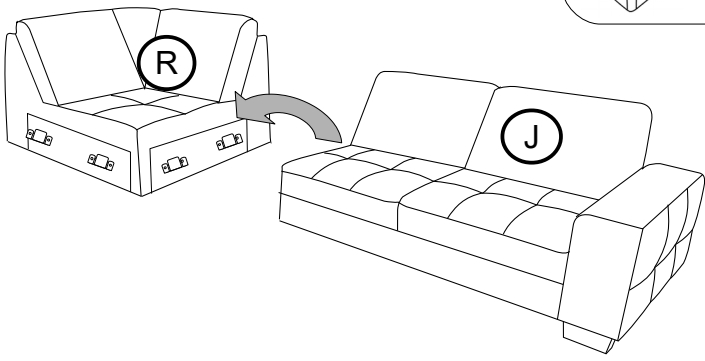
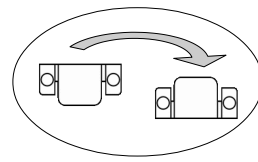
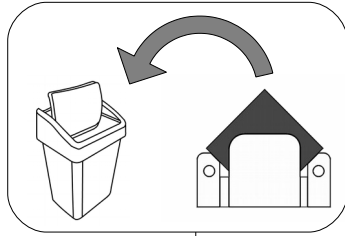
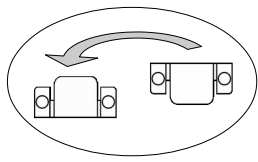

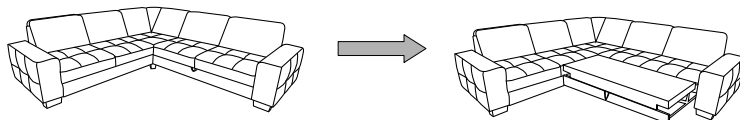

0019

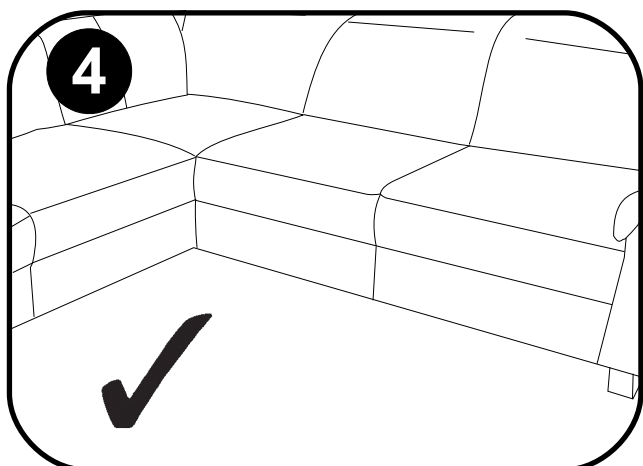
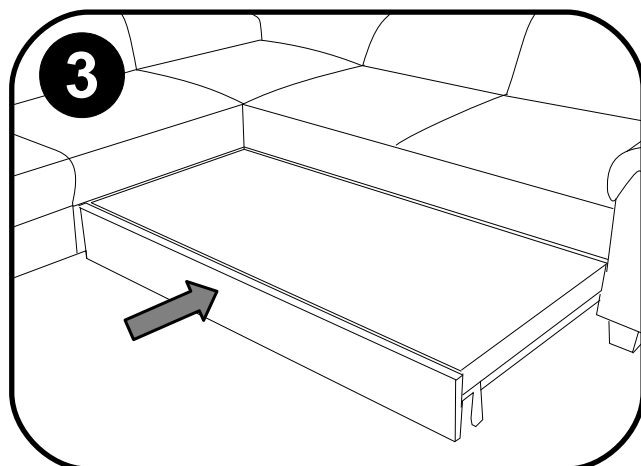
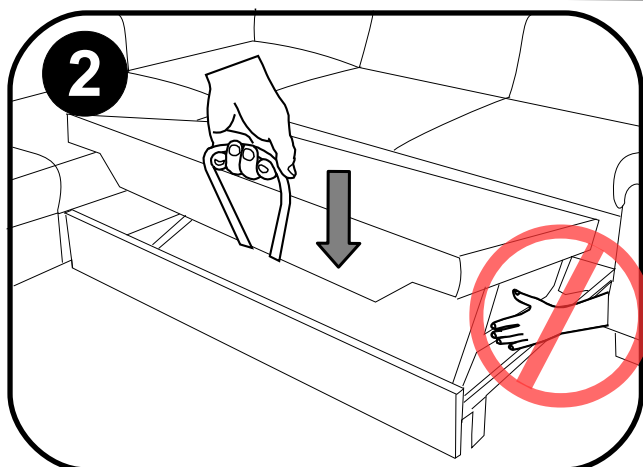
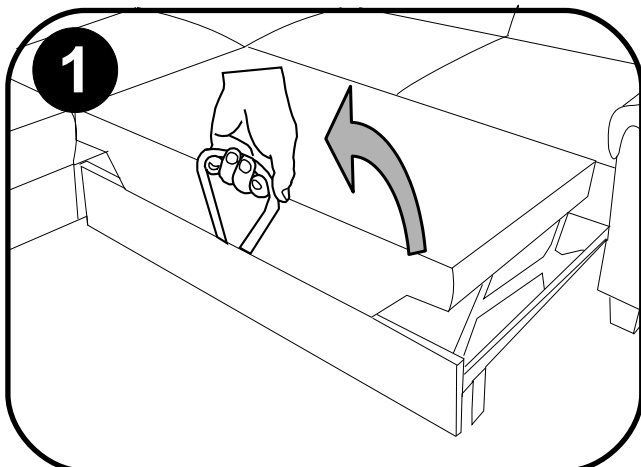
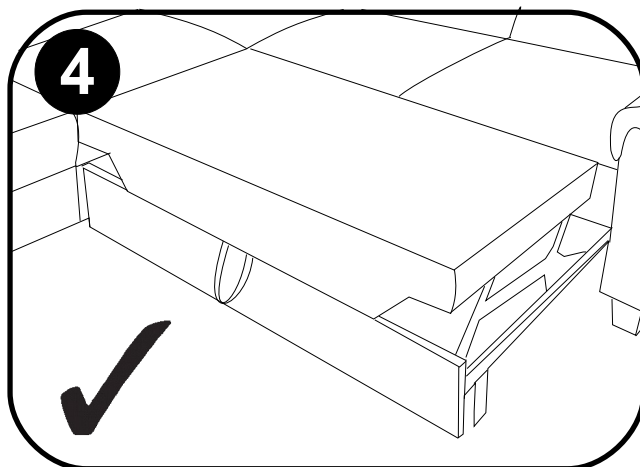
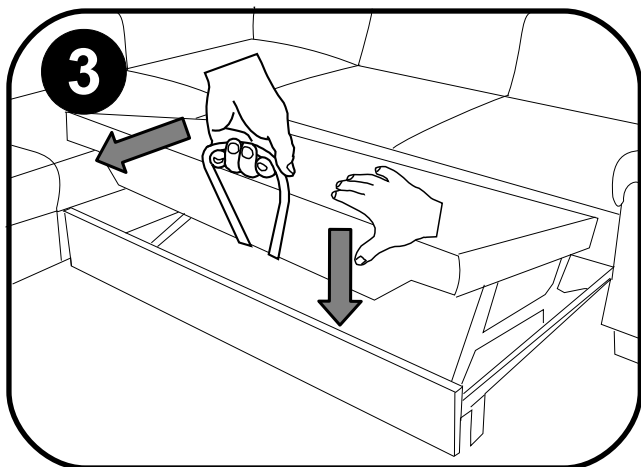
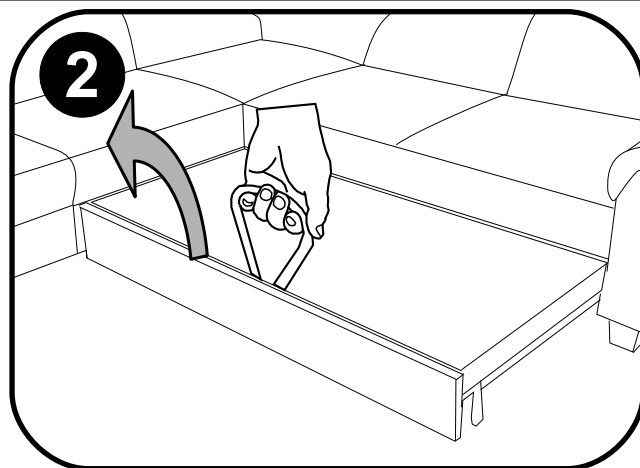
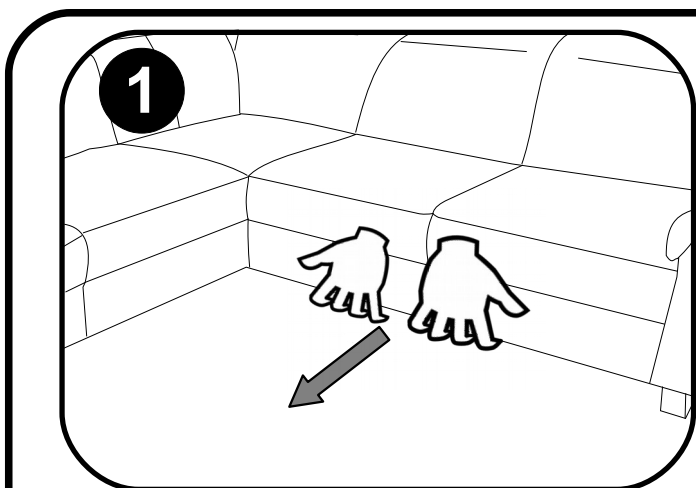

Name · Naam · Nazwa · Ísim · Название · Nume · Nome · Názov · Názov ·
 Název · Neve

PUCINI/PUCCI

Typ · Type · Tip · Тип · Tipo · Típus

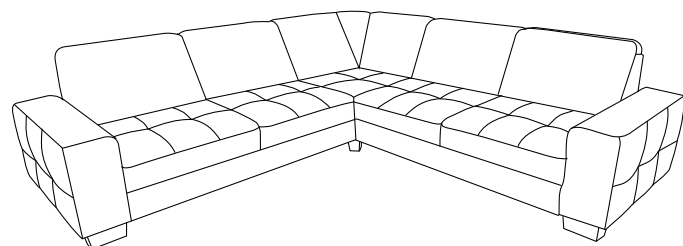
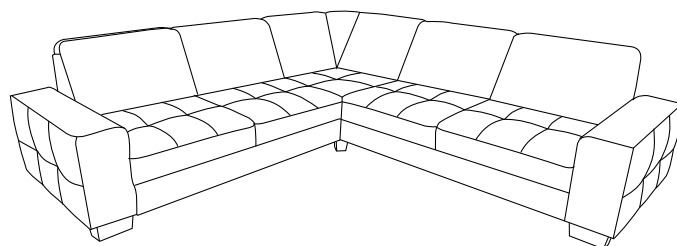
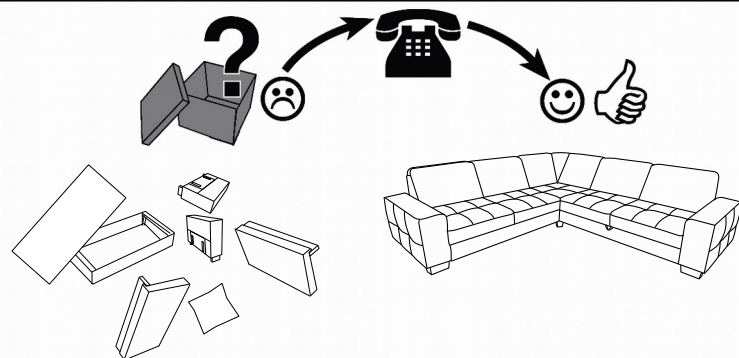
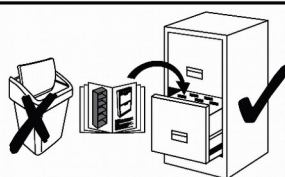

f H-90	x Fi-50	s H-90	q M8*80 [mm]
