

# 980423

1.

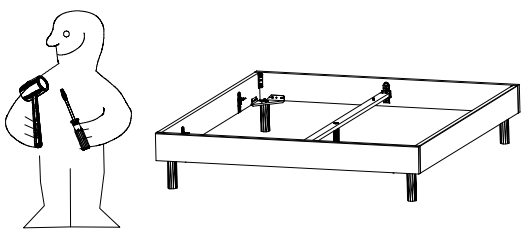

2.

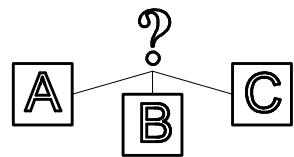
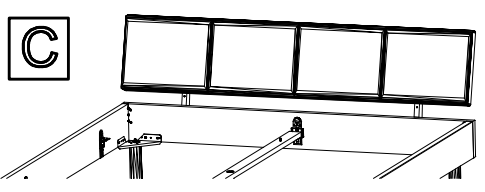
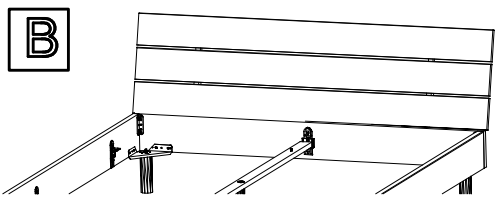
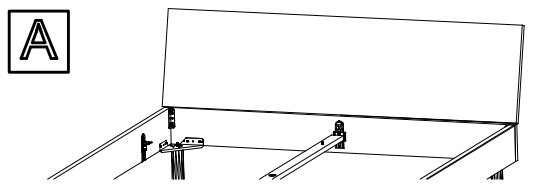
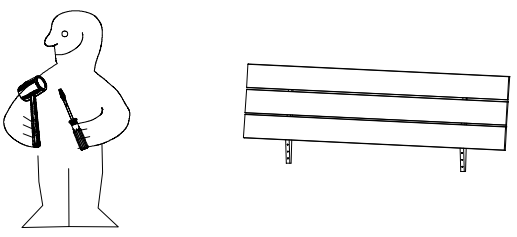

**A**

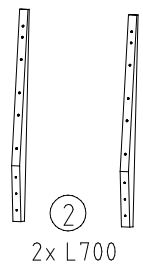
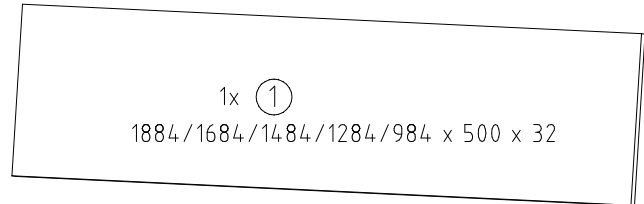

**B**

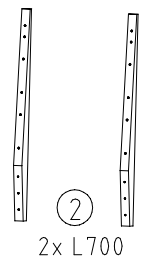
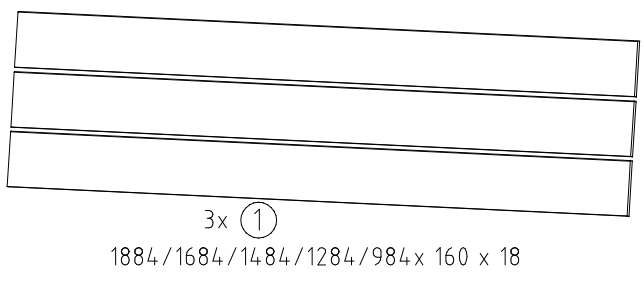

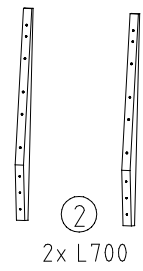
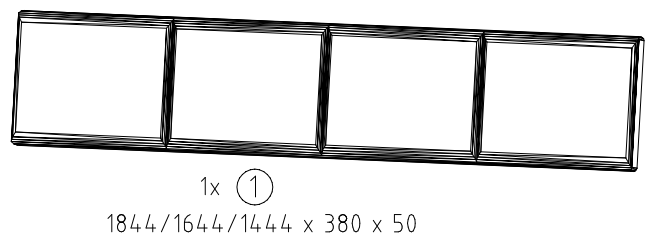

**C**

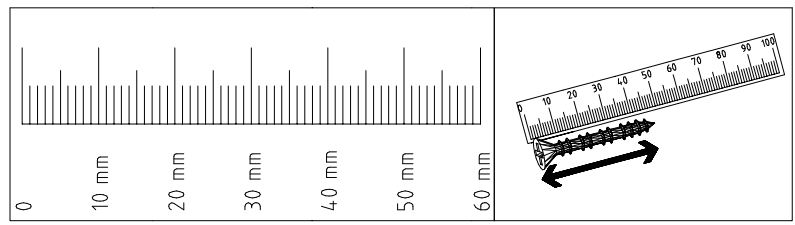
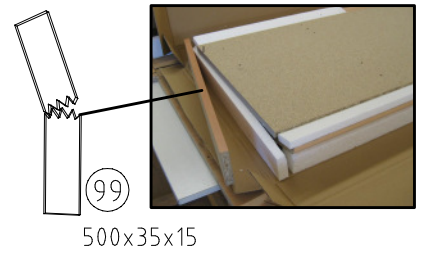
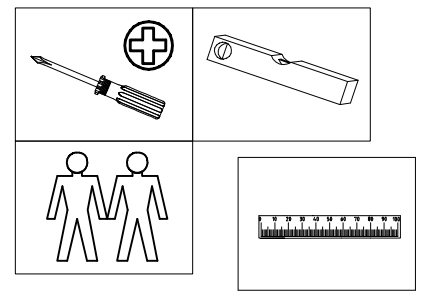

o16	<b>A</b>	<b>B</b>
	2x	
111 004 4,0 x 15 mm	<b>A</b>	<b>B</b>
G23	8x	
121 110 121 115	SP40	
	6x	
4 X 40 mm		
4 X 27mm	<b>A</b>	<b>B</b>
SP27	6x	12x10x
122620		<b>C</b>

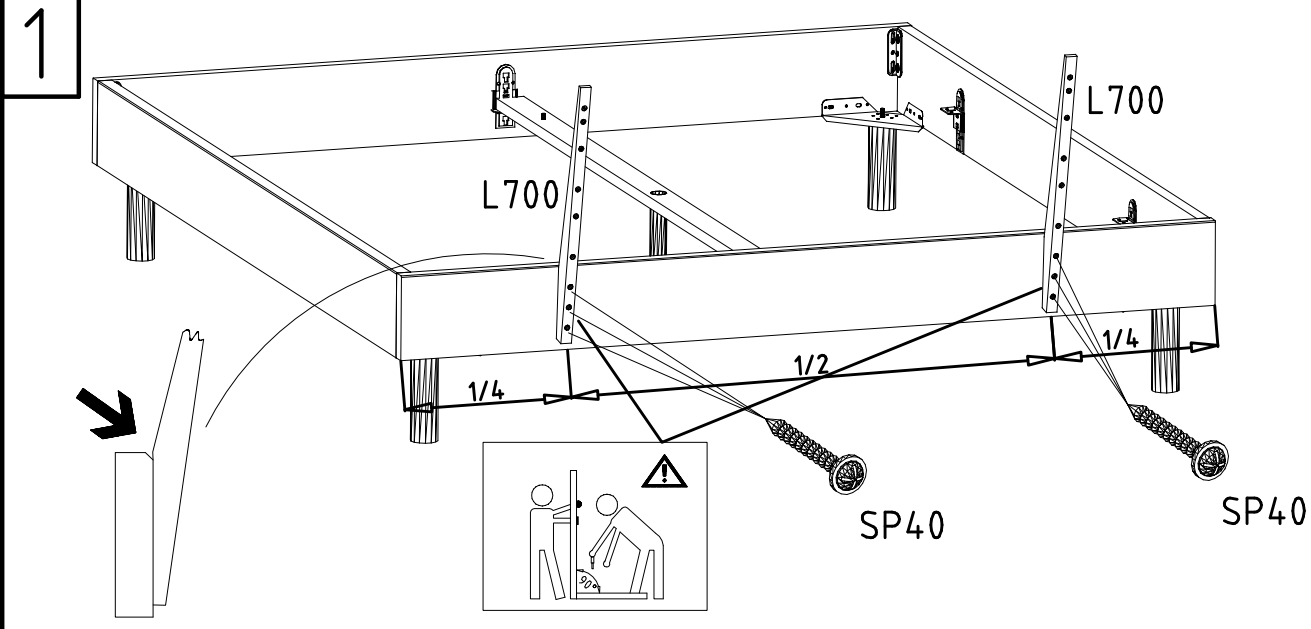

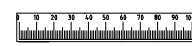

121 115 **SP40**  
  
 4 X 40 mm  
  

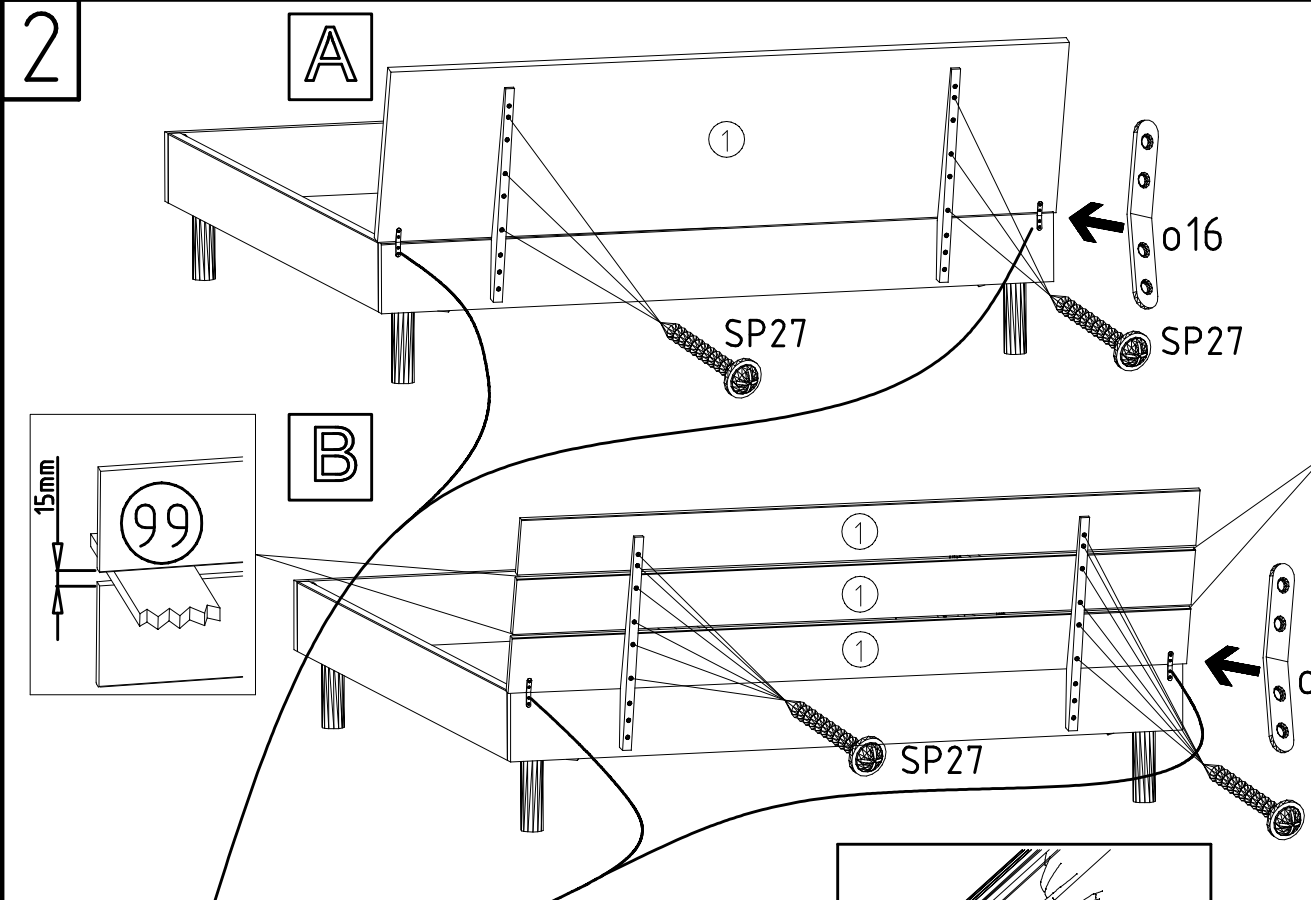

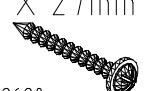
**SP27**  
 4 X 27mm  
  
 122620

**99**  
 15mm

