

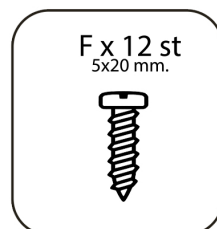

MIAMI

AUFBAUANLEITUNG POLSTERBETT MIAMI

180x200

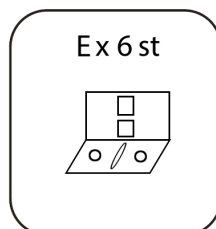
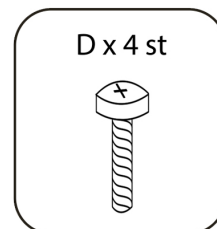
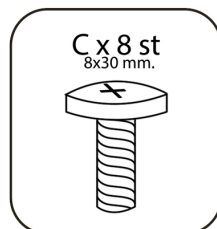
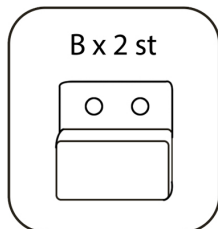
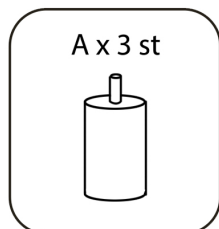
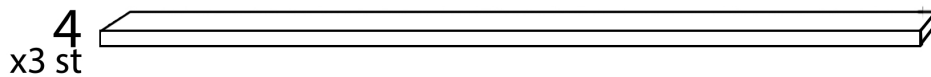
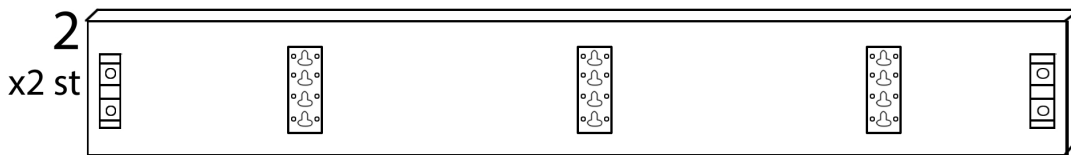
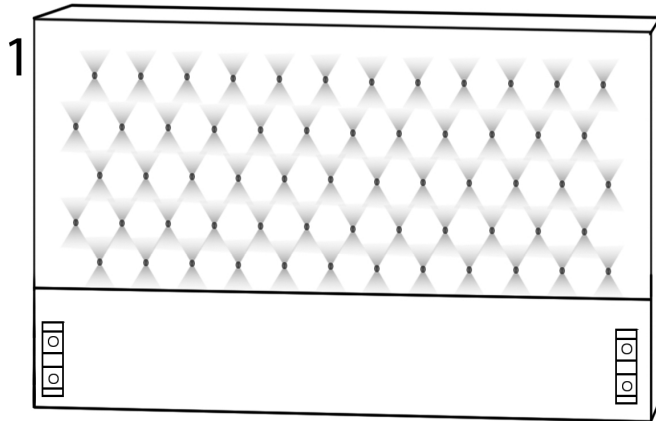

1

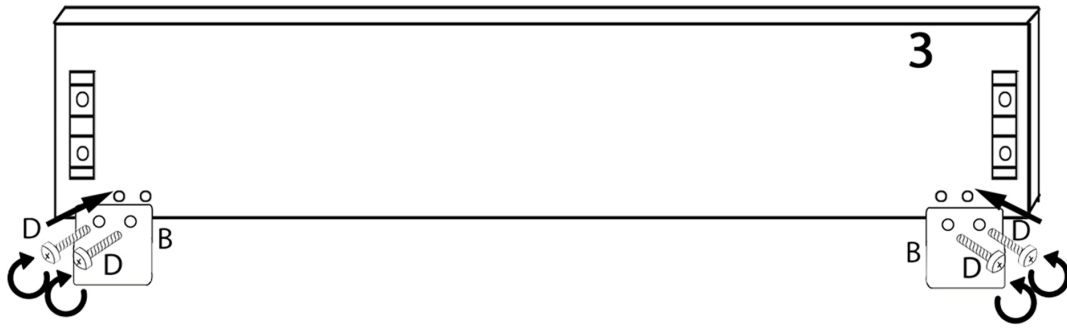

2



3

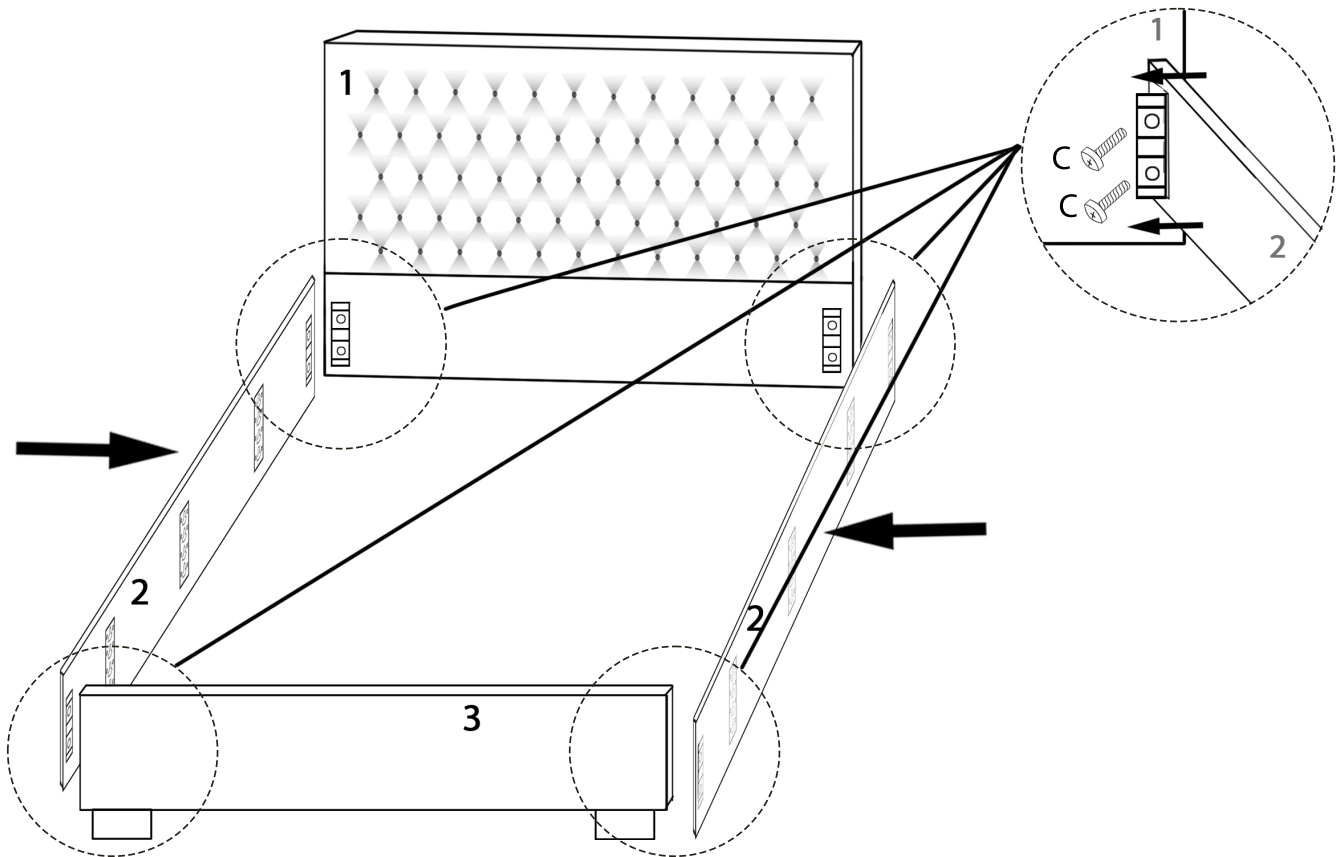

4

Verbinden
sie die Teile
miteinander

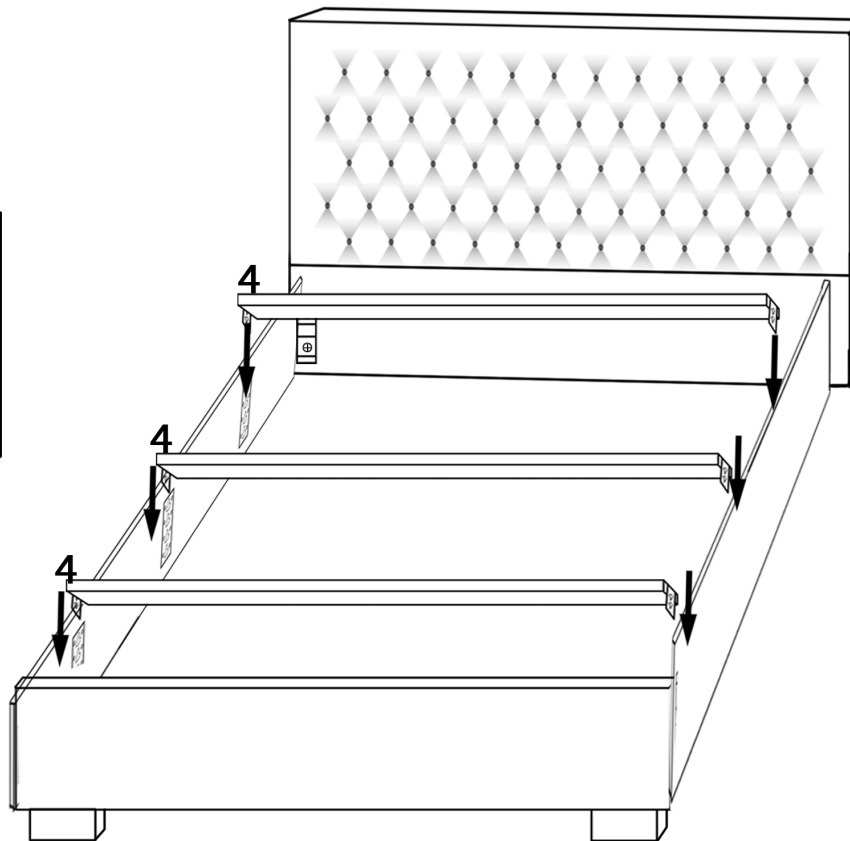

Text

5

Montieren
sie es unter den
Lamellen

