

Paola

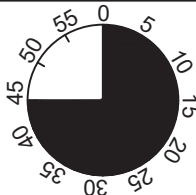

1

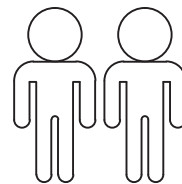
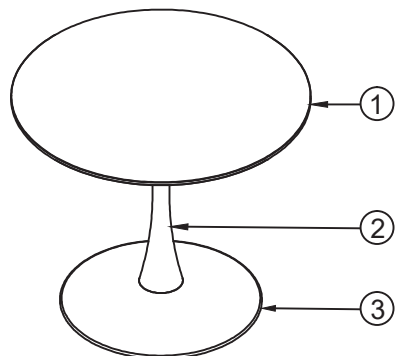
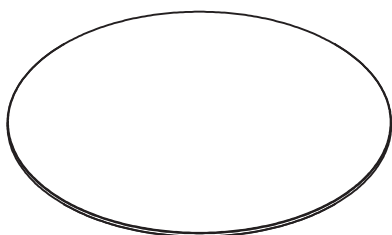

2



3

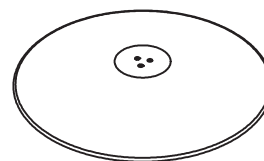

4

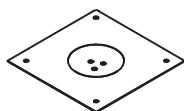

1	1X	1/2
2	1X	2/2
3	1X	2/2
4	1X	2/2



2/2

A

M8x20

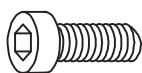

4x

B

M8x25

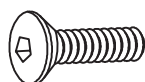

6x

C

Ø18xØ8x1.5



4x

D

M8



4x

E

5MM

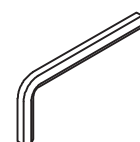

1x

I.

1

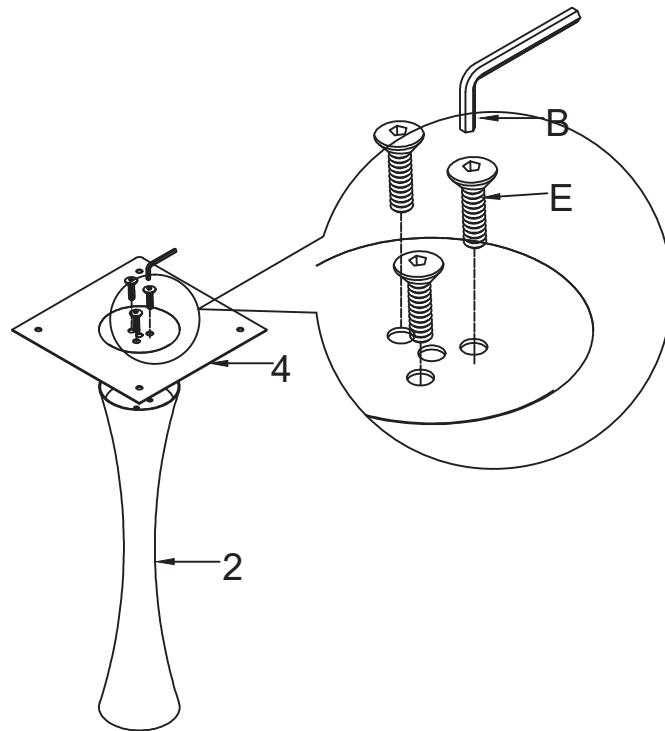

B M8x25

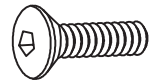

3x
E 5MM



1x



2

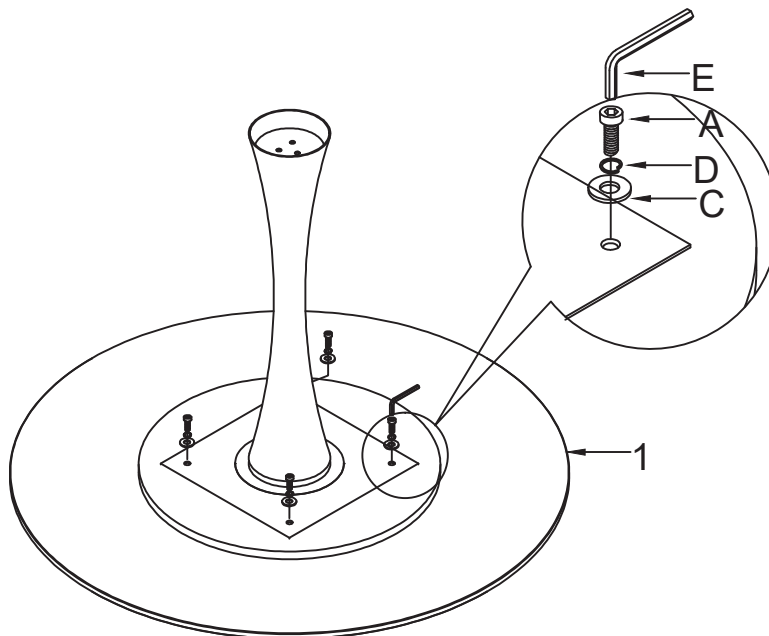

A M8x20

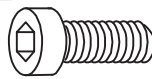

4x
C Ø18xØ8x1.5

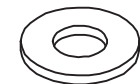

4x
D M8



4x
E 5MM

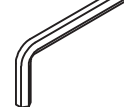

1x



II.

3

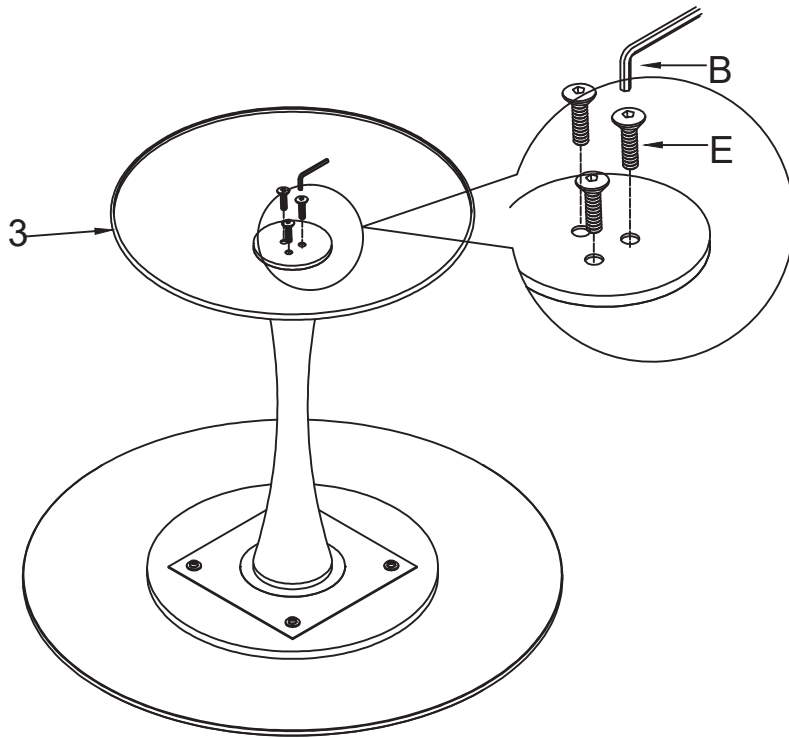

B M8x25

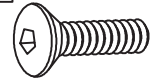

E 3x 5MM

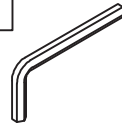

1x



4

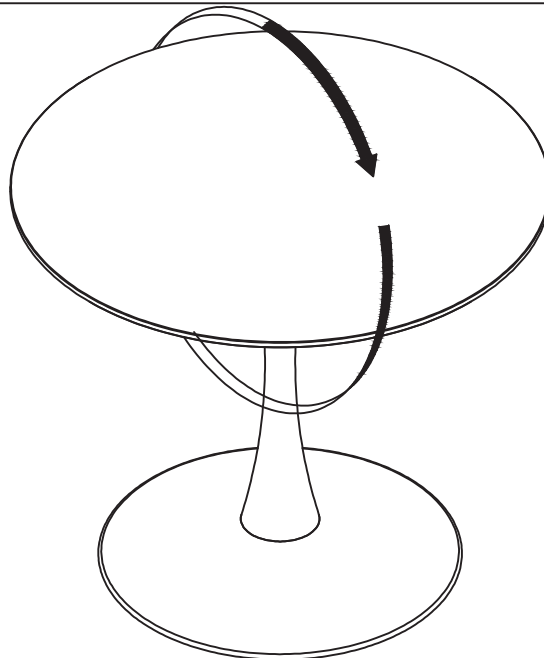

LE TRI
+ FACILE



Séparez les éléments avant de trier