



Bambus US 80 (89222958-97664748)

D Montageanleitung

IT Istruzioni di montaggio

NL Handleiding voor demontage

GB Assembly instructions

F Notice de montage



D

WICHTIG, FÜR SPÄTERE BEZUGNAHME DIESES DOKUMENT AUFBEWAHREN! SORGFÄLTIG LESEN!

Bestimmungsgemäßer Gebrauch

Das Produkt ist ausschließlich für den Privatgebrauch bestimmt und nicht für gewerbliche Anwendungen geeignet. Verwenden Sie es nur in Innenräumen. Das Produkt ist kein Kinderspielzeug.

Verwenden Sie es nur wie in dieser Montageanleitung beschrieben. Jede andere Verwendung gilt als nicht bestimmungsgemäß und kann zu Sachschäden führen.

Der Hersteller oder Händler übernimmt keine Haftung für Schäden, die durch nicht bestimmungsgemäßen oder falschen Gebrauch entstanden sind..



Sicherheitshinweise

- Erstickungs- / Verletzungsgefahr! Lassen Sie Kinder nicht mit der Verpackung spielen. Sie könnten an der Folie ersticken oder sich an der Umverpackung verletzen.
- Achten Sie darauf, dass Kinder keine kleinen Teile, wie z. B. Muttern, Abdeckkappen oder Ähnliches in den Mund nehmen. Sie könnten sie verschlucken und daran ersticken.
- Beschädigungsgefahr! Gehen Sie bei der Montage des Artikels sorgfältig vor und halten Sie sich an die Montageanleitung.
- Stoßen Sie nicht mit harten Gegenständen an die Flächen oder -kanten.
- Nur wenn alle Teile ordnungsgemäß arretiert sind, kann eine sichere Benutzung des Artikels gewährleistet werden.
- Sämtliche Bestandteile sind von offenem Feuer fernzuhalten.

Pflegehinweise

- Entfernen Sie Verunreinigungen mit einem leicht angefeuchteten Tuch. Verwenden Sie keinesfalls aggressive oder Lösemittel enthaltende Reinigungsmittel. Diese könnten die Oberflächen beschädigen

NL

BELANGRIJK, BEWAREN VOOR LATERE REFERENTIE! ZORGVULDIG DOORLEZEN!

Reglementair gebruik

Het product is uitsluitend bedoeld voor privégebruik en niet geschikt voor commerciële doeleinden. Gebruik het alleen binnenshuis. Het product is geen kinderspeelgoed. Gebruik het alleen zoals in deze montagehandleiding beschreven. Elk ander gebruik geldt als niet-reglementair en kan tot materiële schade leiden.

De fabrikant of dealer accepteert geen enkele aansprakelijkheid voor schade die door een onreglementair of onjuist gebruik is ontstaan.



Veiligheidsinstructies

- Verstikkings- of letselrisico! Laat kinderen niet met de verpakking spelen. Ze kunnen door de folie stikken of letsel oplopen door de omverpakking.
- Zorg ervoor dat kinderen geen kleine onderdelen zoals moeren, afdekkapjes of dergelijke in hun mond stoppen. Ze kunnen deze inslikken of hierdoor stikken.
- Risico op schade! Ga bij de montage van het artikel zorgvuldig te werk en volg hierbij de montagehandleiding.
- Stoot niet met harde voorwerpen tegen de oppervlakken of zijkant.
- Alleen als alle onderdelen correct vastzitten, kunt u het artikel veilig gebruiken.
- Alle onderdelen moeten uit de buurt van open vuur worden gehouden.

Onderhoudsinstructies

- Verwijder verontreinigingen met een licht vochtige doek. Gebruik in geen geval agressieve of oplosmiddelhoudende reinigingsmiddelen. Deze kunnen het oppervlak eventueel beschadigen.

FR

IMPORTANT : CONSERVER CE DOCUMENT POUR CONSULTATION ULTÉRIEURE ! À LIRE ATTENTIVEMENT !

Usage conforme

Ce produit est destiné exclusivement à l'usage domestique, et ne convient pas pour des applications commerciales. Utilisez-le uniquement à l'intérieur. Ce produit n'est pas un jouet pour les enfants. Utilisez-le uniquement conformément aux instructions de montage qui vous sont données ici.

Toute autre utilisation est considérée comme non conforme et peut entraîner des dommages matériels.

Le fabricant ou le commerçant déclinent toute responsabilité pour des dommages engendrés par une utilisation non conforme ou erronée.



Consignes de sécurité

- Risque d'asphyxie / de blessure ! Ne laissez pas jouer les enfants avec l'emballage. Ils risqueraient de s'étouffer avec le film plastique ou de se blesser avec l'emballage.
- Faites attention à ce que les enfants ne mettent pas à la bouche des petites pièces telles des écrous, des couvercles de protection ou d'autres pièces similaires. Ils risqueraient de les avaler et de s'étouffer.
- Risque de détérioration ! Procédez soigneusement au montage du produit et respectez le mode d'emploi.
- Ne heurtez pas les surfaces ou les arêtes avec des objets durs.
- Une utilisation sécurisée du produit est garantie uniquement si toutes les pièces sont bloquées en bonne et due forme.
- Tous les composants doivent être conservés à l'abri de toute source de flammes.

Consignes d'entretien

- Éliminez les impuretés avec un chiffon légèrement humidifié. N'utilisez en aucun cas des détergents agressifs ou contenant des solvants. Ceux-ci risqueraient d'endommager les surfaces.

IT

IMPORTANTE: CONSERVARE QUESTO DOCUMENTO PER LA SUCCESSIVA CONSULTAZIONE! LEGGERE ATTENTAMENTE!

Utilizzo conforme alla destinazione d'uso

Il prodotto è destinato esclusivamente all'uso privato e non è adatto all'utilizzo professionale. Utilizzarlo soltanto in ambienti interni. Il prodotto non è un giocattolo. Utilizzarlo soltanto come descritto nelle presenti istruzioni di montaggio.

Ogni altro utilizzo è da considerarsi come non conforme alla destinazione d'uso e può provocare danni materiali.

Il produttore o il rivenditore declina ogni responsabilità per i danni provocati da utilizzo non conforme alla destinazione d'uso o non corretto.



Avvertenze per la sicurezza

- Pericolo di soffocamento/lesioni! Non lasciare che i bambini giochino con la confezione del prodotto. Potrebbero soffocarsi con la pellicola o ferirsi con l'imballaggio.
- Fare attenzione a che i bambini non mettano in bocca piccole parti come per esempio dadi, tappi di copertura o simili. Potrebbero ingoiarle e soffocare.
- Pericolo di danneggiamento! Procedere con cautela nel montaggio dell'articolo e attenersi alle istruzioni di montaggio.
- Non urtare con oggetti duri le superfici o i bordi del prodotto.
- Soltanto quando tutte le parti sono correttamente fissate può essere garantito un utilizzo sicuro dell'articolo.
- Tutti i componenti devono essere tenuti lontano da fiamme libere.

Istruzioni di manutenzione

- Rimuovere lo sporco con un panno leggermente inumidito. Non utilizzare in nessun caso detergenti aggressivi o contenenti soluzioni. Queste sostanze potrebbero danneggiare le superfici.

GB

IMPORTANT! KEEP THIS DOCUMENT FOR FUTURE REFERENCE! READ CAREFULLY!

Intended use

The product is intended for private use only and not suitable for commercial applications. For indoor use only. The product is not a toy. It must only be used according to these installation instructions. Any other use is considered improper and may lead to damage.

The manufacturer or retailer can assume no liability for any damages that are the result of improper or incorrect use.











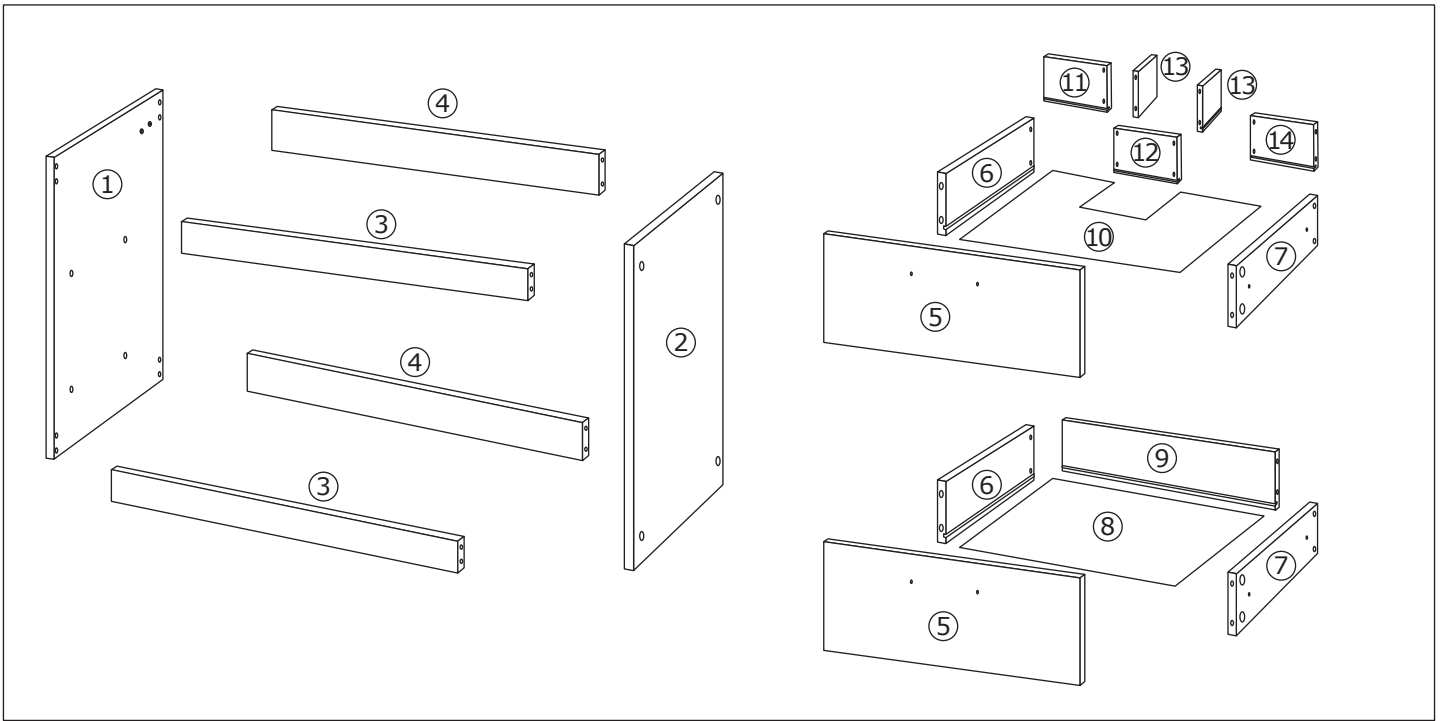

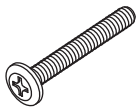

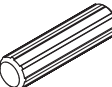
Safety instructions

- Risk of suffocation / injury! Do not allow children to play with the packaging materials. The plastic film may cause suffocation and injuries may be caused by the outer packaging.
- Supervise children to ensure that they will not put any small parts such as nuts, covering caps or similar into their mouth. Otherwise such parts may be swallowed or cause choking.
- Risk of damage! Install the product carefully and observe the installation instructions.
- Avoid impact to the surfaces or edges with hard objects.
- Safe use of the product can only be ensured if all components are properly fixed in place.
- All components must be kept away from open fire.

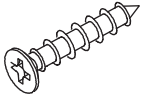
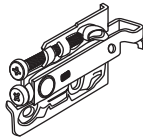
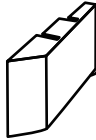
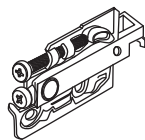
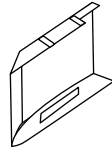
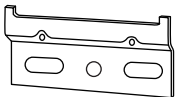
Care instructions

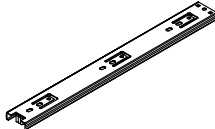
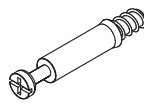
- Use a damp cloth to remove any soiling. Do not use cleaning agents that are aggressive or that contain solvents. These may cause damage to the surfaces.

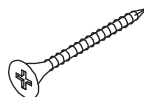

					
A x 8	B x 8	C x 8	D x 2	E x 4	F x 16
					
G x 16	H x 1	I x 1	J x 1	K x 1	L x 2
					
M x 4	N x 4	O x 8	P x 8	Q x 6	R x 6

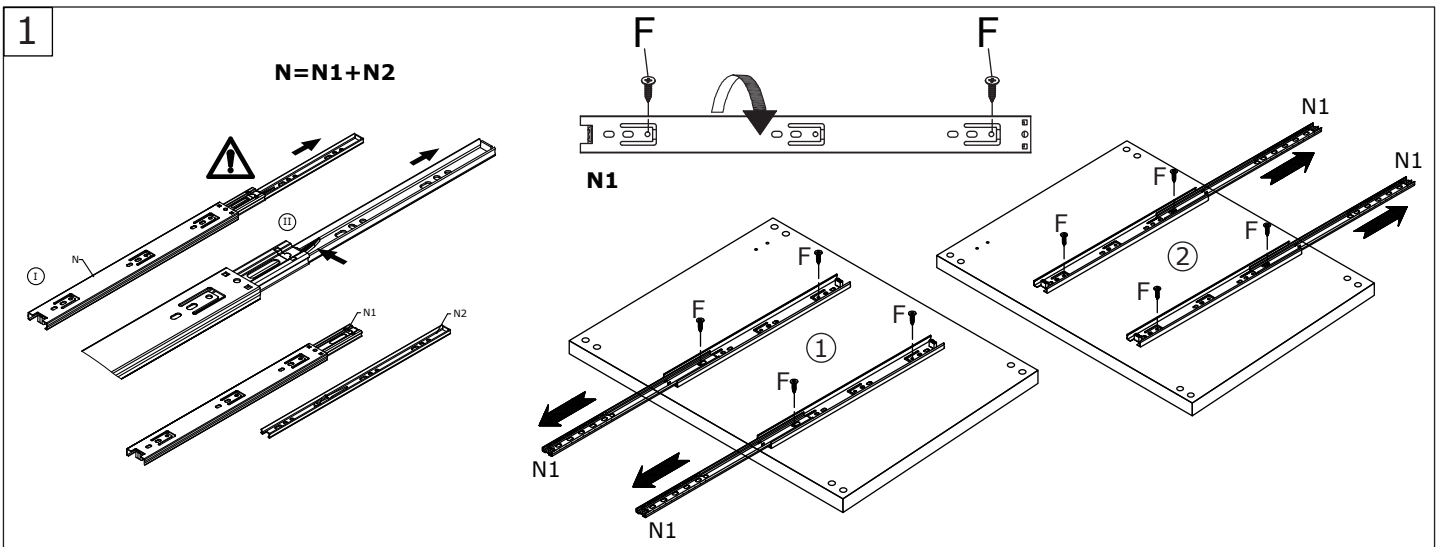

2

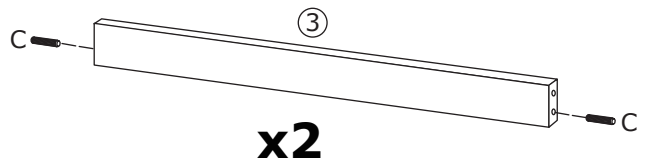
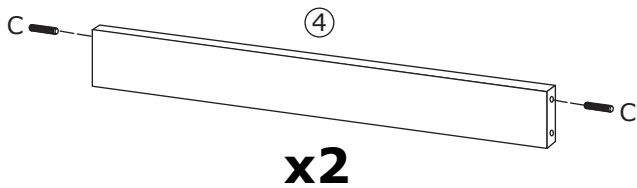

3

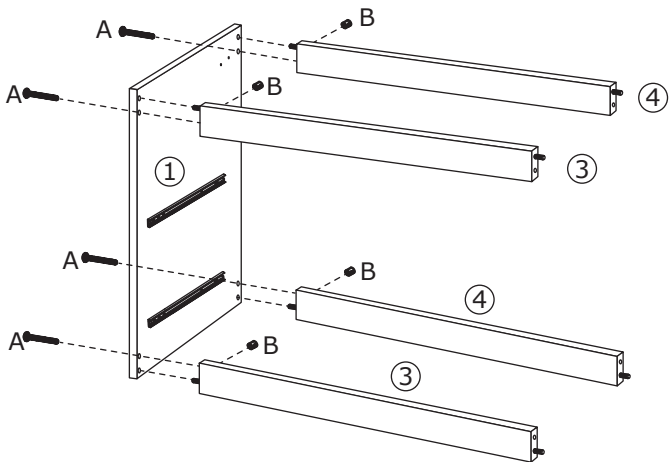

4

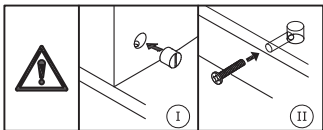
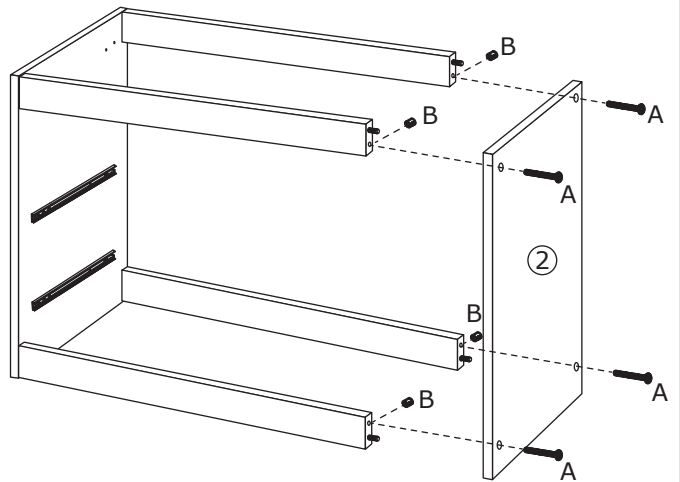

5

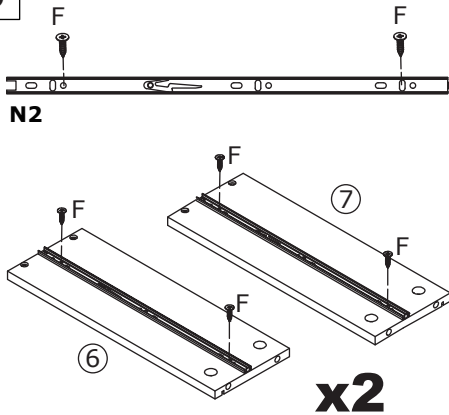

6

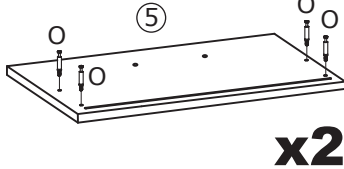

7

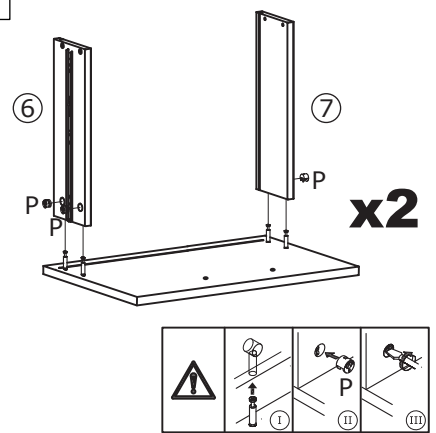

8

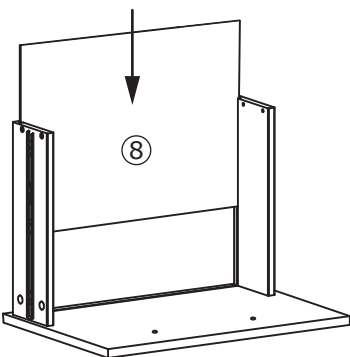

9

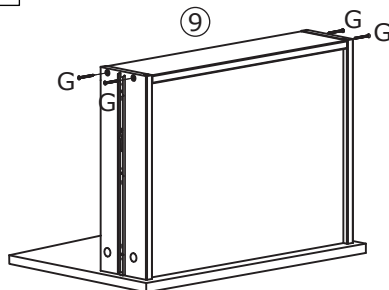

10

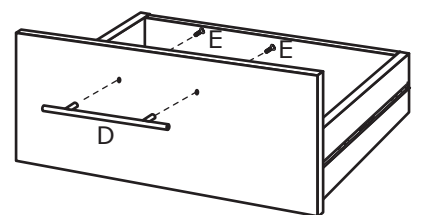

11

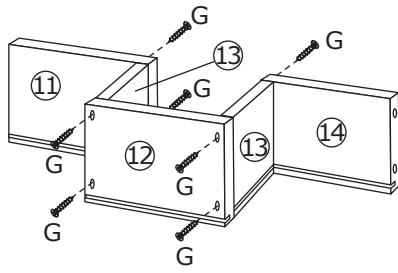

12

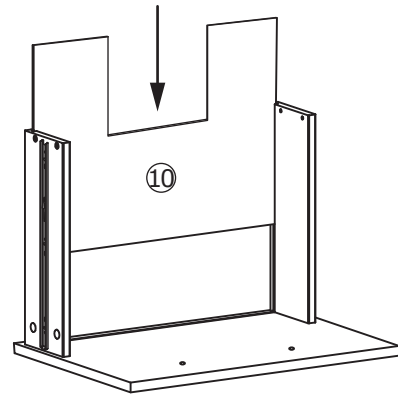

13

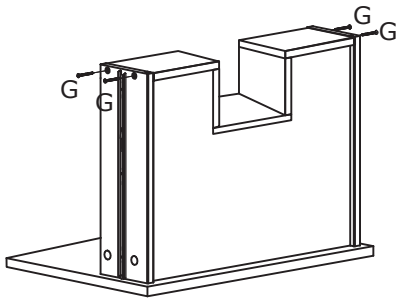

14

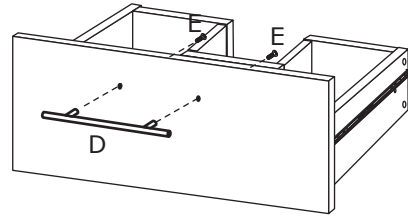

15

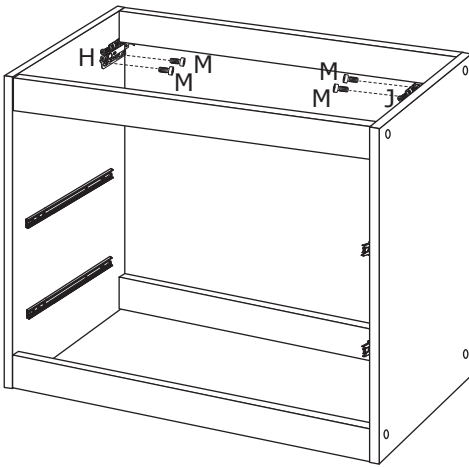

16

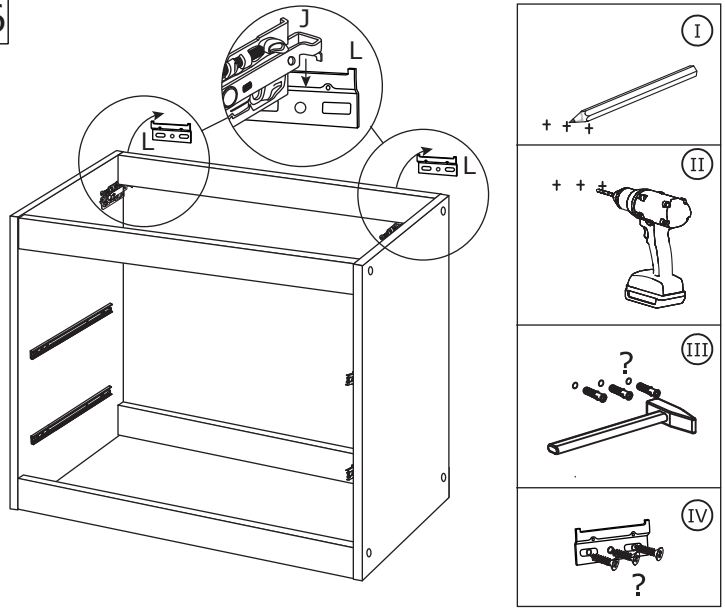

17

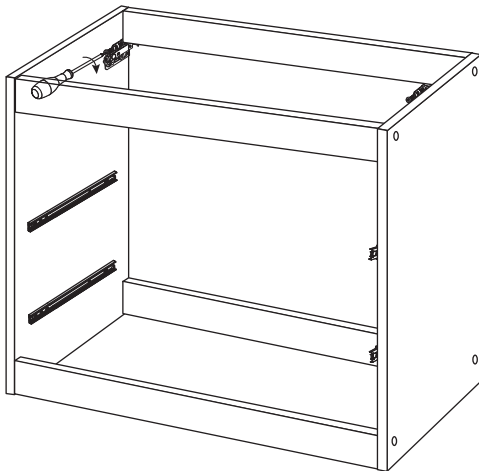

18

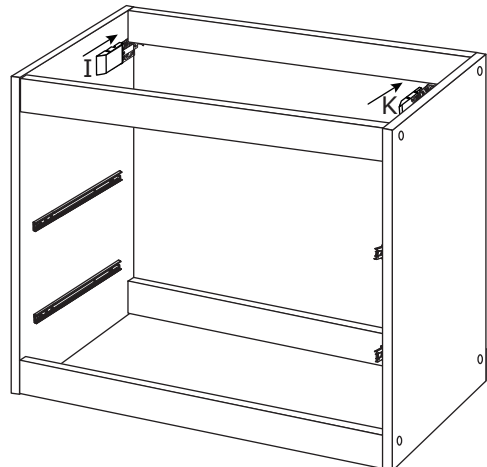

19

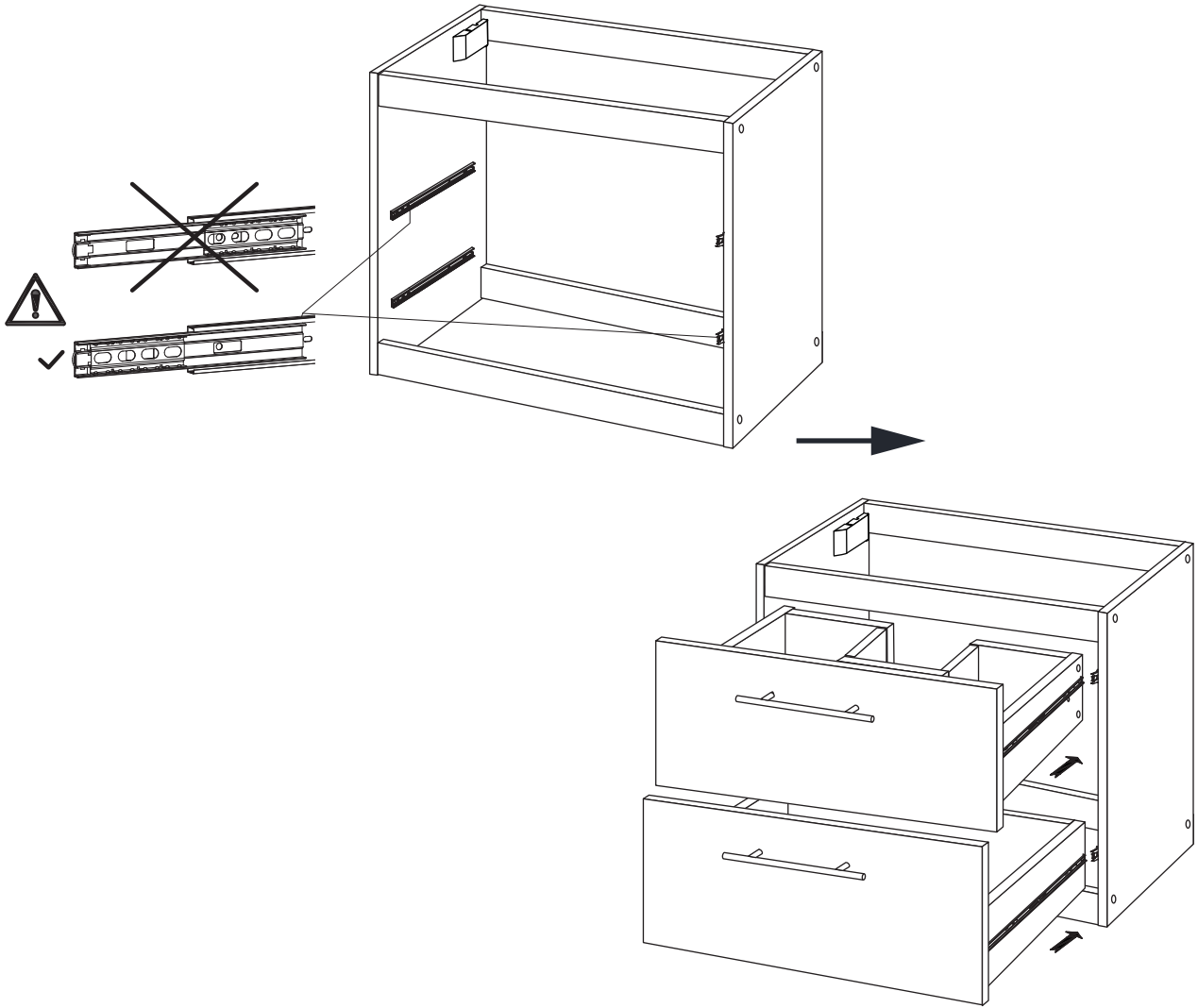

20

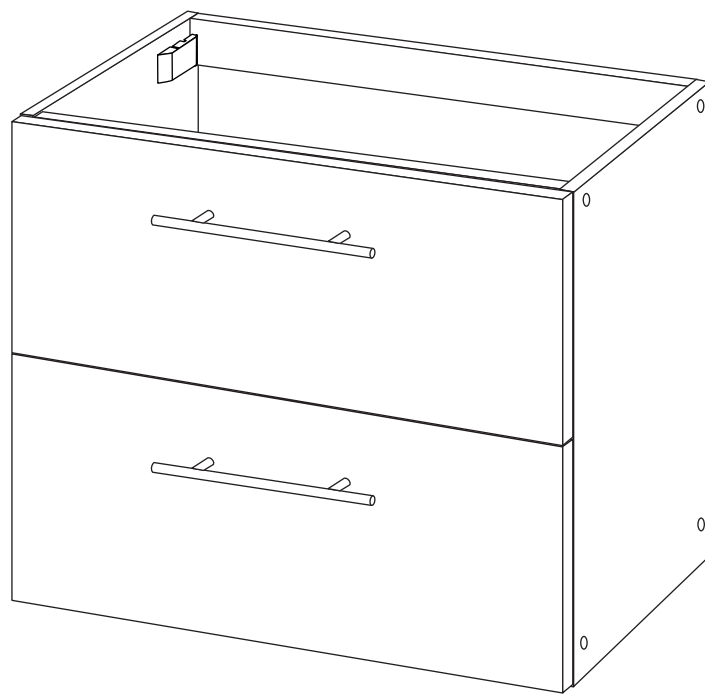

Service

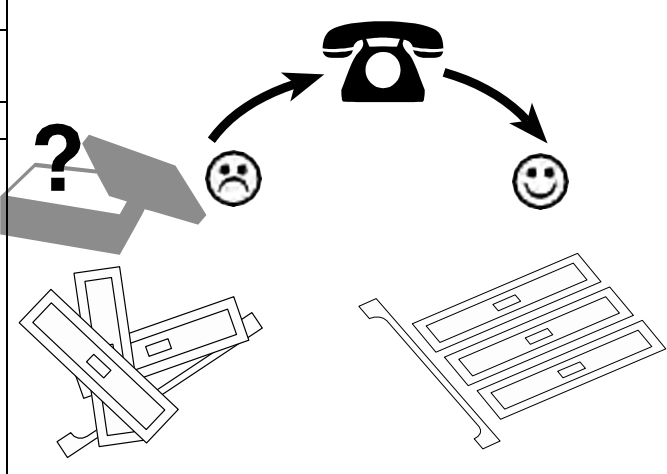
Name	Bambus US 80	
No.	89222958-97664748	
Type		

D

Produktberatung: 01806/ 63 06 30 Festnetz 20 Cent/Anruf, Mobilfunk max. 60 Cent/Anruf Quelle D
Fachberatung: 01806/111 100 Festnetz 20 Cent/Anruf, Mobilfunk max. 60 Cent/Anruf

NL

call center telefoonnummer 0900-1901 15 ct/min

A

Universal: 0043/662/4485 59 Fachberatung Heimwerken (zum Festnetztarif – je nach Betreiber) Otto:
0043/316/606 888 Beratung Heimwerken (zum Festnetztarif – je nach Betreiber)
Quelle: 0043/662/9005 59 Fachberatung Heimwerken (zum Festnetztarif – je nach Betreiber)

CH

Bei Problemen oder Fragen wenden Sie sich bitte an unsere Servicehotline!
Quelle CH: 0848 85 85 00 Ackermann CH: 0848 85 85 11, Jelmoli Technik: 0848 840 300

F

Si vous avez des problèmes ou des questions, contactez notre service en ligne!
Quelle CH: 0848 85 85 01 Ackermann CH: 0848 85 85 21, Jelmoli Technik: 0848 840 300

I

Se ha problemi o domande si rivolge al nostro servizio di assistenza!
Quelle CH: 0848 85 85 02 Ackermann CH: 0848 85 85 31, Jelmoli Technik: 0848 840 300

**Imported by AproductZ GmbH Werner-Otto-Str.
1-7 22179, Hamburg, Germany**