

- | | | | |
|------|-----------------------------|------|-------------------------|
| (D) | Montageanleitung | (FR) | Notice de montage |
| (NL) | Handleiding voor de montage | (CZ) | Montážní návod |
| (HU) | Szerelési útmutató | (TR) | Montaj talimatı |
| (GB) | Assembly instructions | (IT) | Istruzioni di montaggio |
| (PL) | Instrukcja montażu | (SK) | Návod na montáž |
| (RO) | Instrucțiuni de montaj | (RU) | Инструкция по монтажу |

Service • Assistenza • Dienstverlening • Serwis Servis • Szerviz • Сервисная служба

Name • Nom • Nome • Naam •
Nazwa • Jméno • Názov • Név •
Denumire • Ísim • Название

Nr. • No. • N° • Номер • Č • Sz

Tур • Type • Tip • Típus • Típo •
Тип

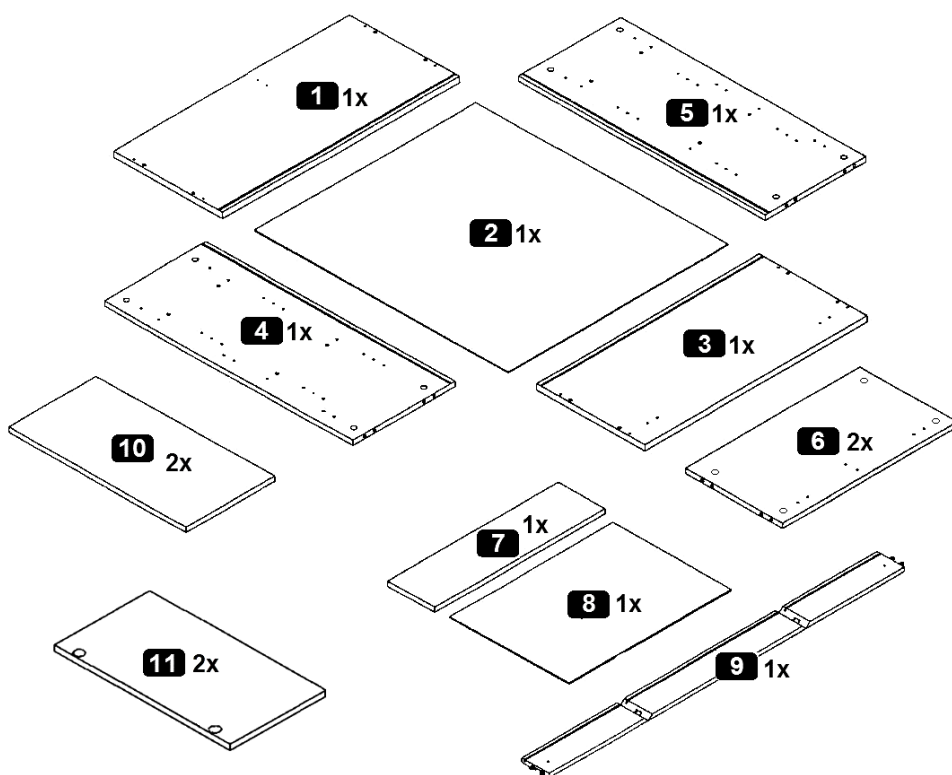
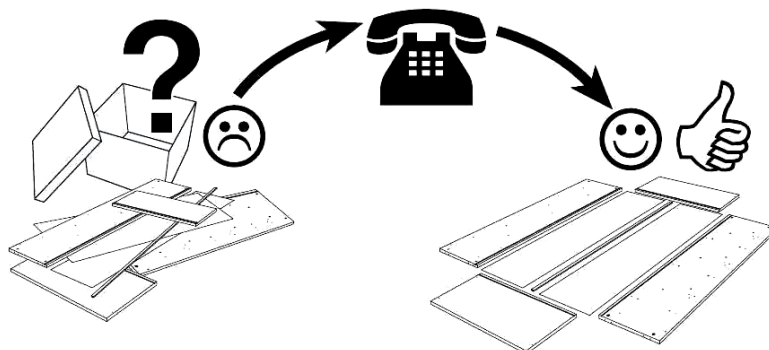
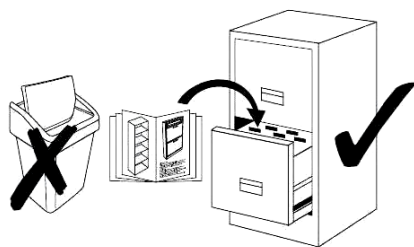



1	1x	ca. 885 x 350 mm
2	1x	ca. 864 x 864 mm
3	1x	ca. 885 x 350 mm
4	1x	ca. 850 x 330 mm
5	1x	ca. 850 x 330 mm
6	2x	ca. 854 x 315 mm
7	1x	ca. 880 x 120 mm
8	1x	ca. 833 x 307 mm
9	1x	ca. 1486 x 89 mm
10	2x	ca. 854 x 300 mm
11	2x	ca. 880 x 359 mm





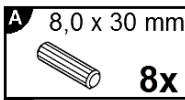
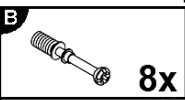

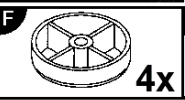
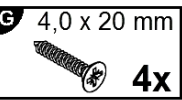
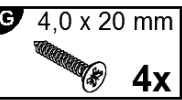
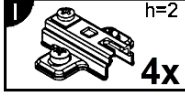
A 8,0 x 30 mm 16x	B 16x	C 16x	D 3x	E 3,9 x 9,5 mm 6x	F 4x	G 4,0 x 20 mm 4x
H 4x Ø35 Kr.15 3,5x13 mm	I 4x h=2	J 8x	K 2,7 x 20 mm 6x	L 17 x 310 mm 2x	M 6,3 x 13 mm 4x	N M4,0 x 9 mm 2x
O 2x 200 mm	P 1x	Q 3,5 x 13 mm 12x	R 4x			

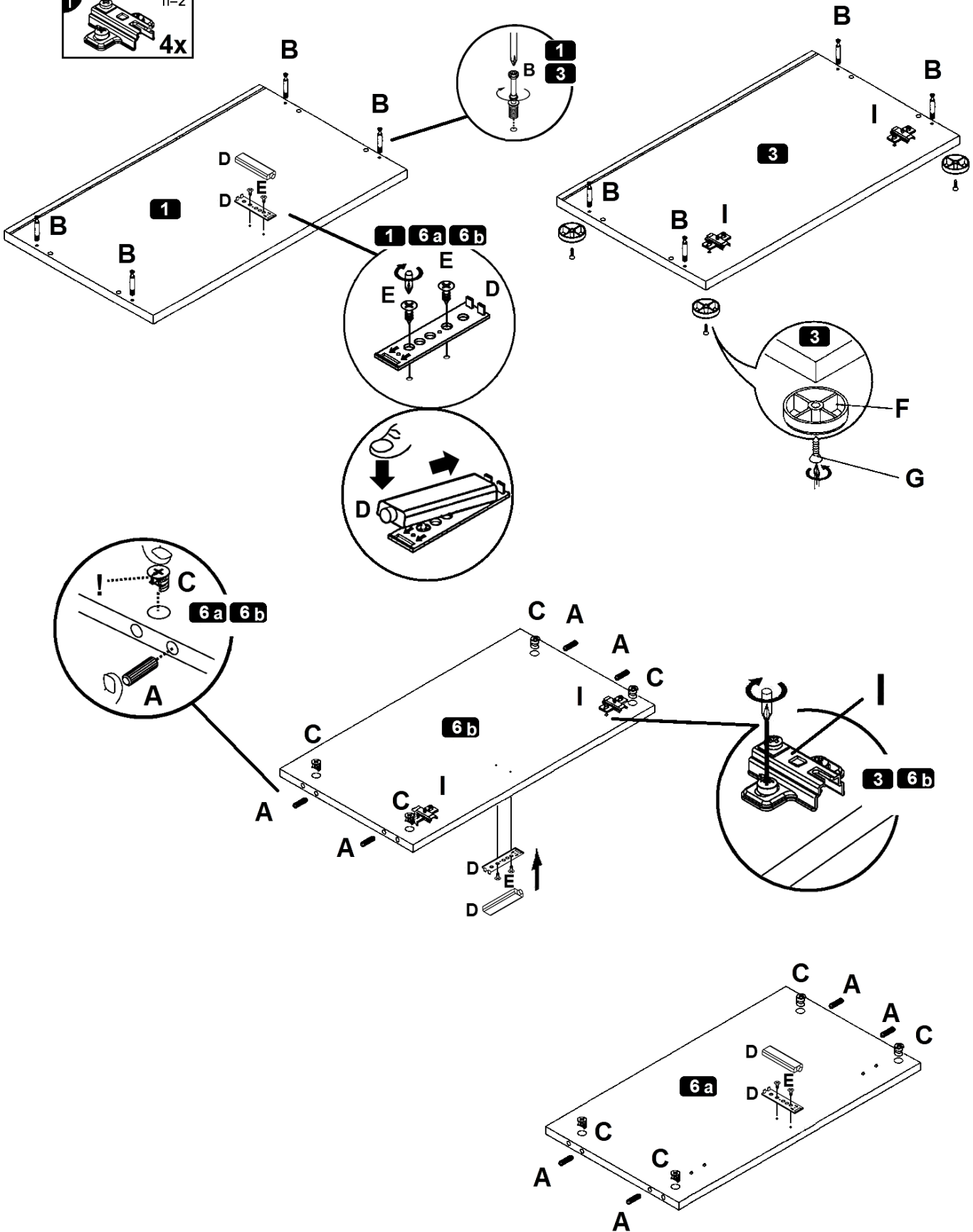
1

- | | | | | | |
|--|---|---|---|--|---|
| A 8,0 x 30 mm
 8x | B  8x | D  3x | E 3,9 x 9,5 mm
 6x | F  4x | G 4,0 x 20 mm
 4x |
| I  4x
h=2 | | | | | |

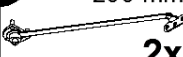
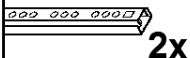

2

A 8,0 x 30 mm  8x	B  8x	C  8x	Q 3,5 x 13 mm  6x	M 6,3 x 13 mm  4x	O 200 mm  2x
L 17 x 310 mm  2x					

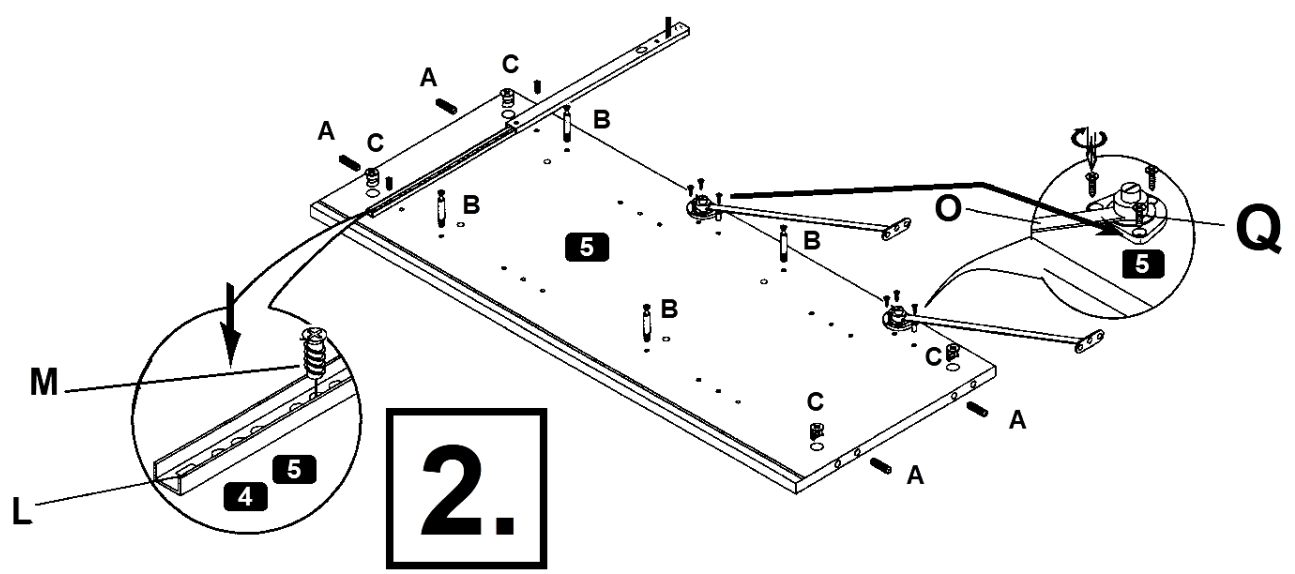
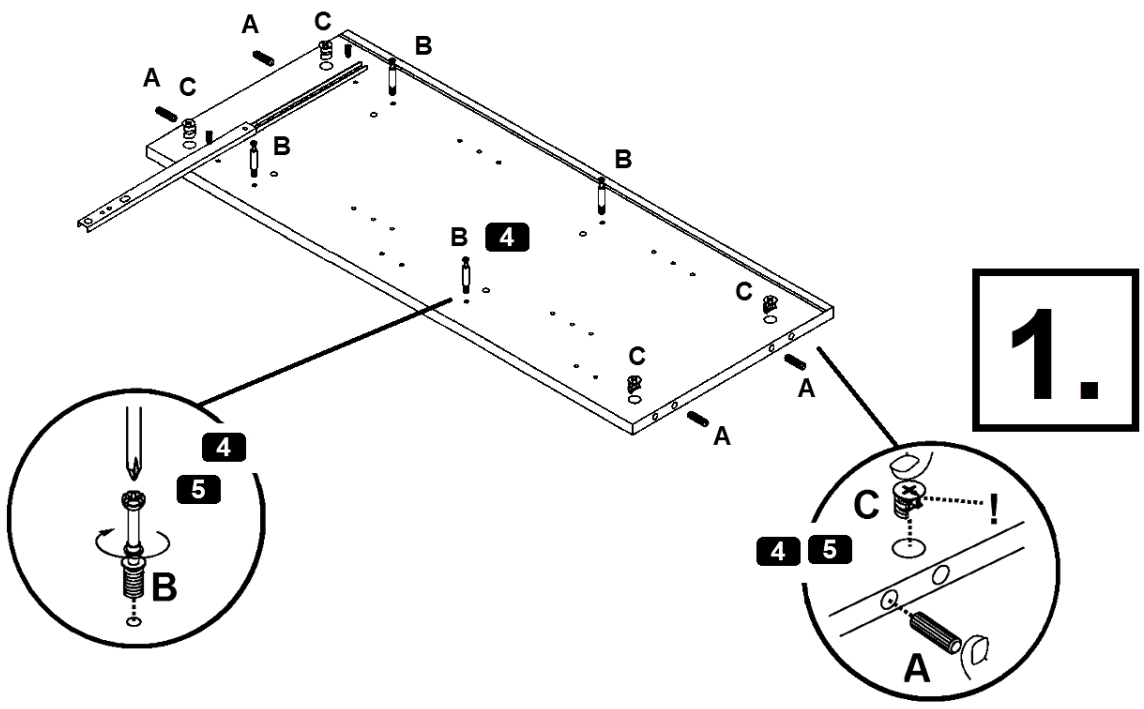

3

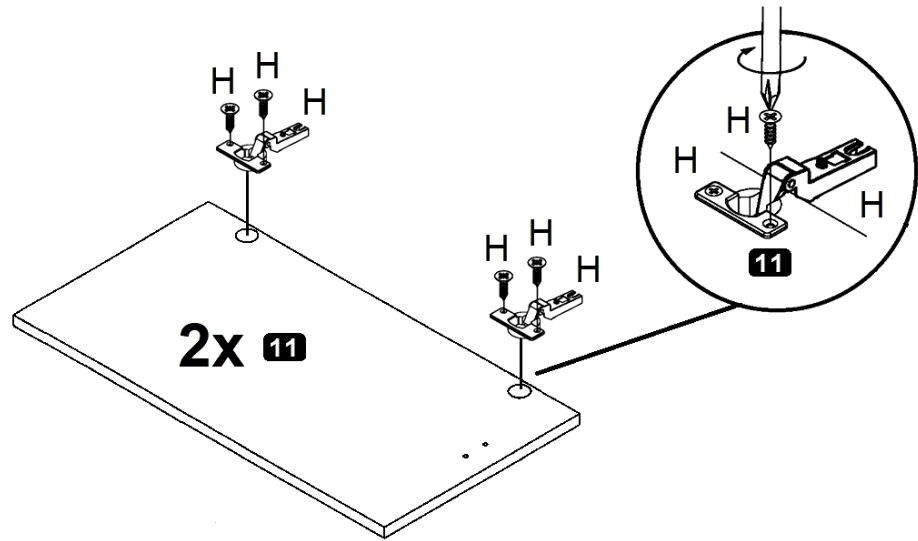

4

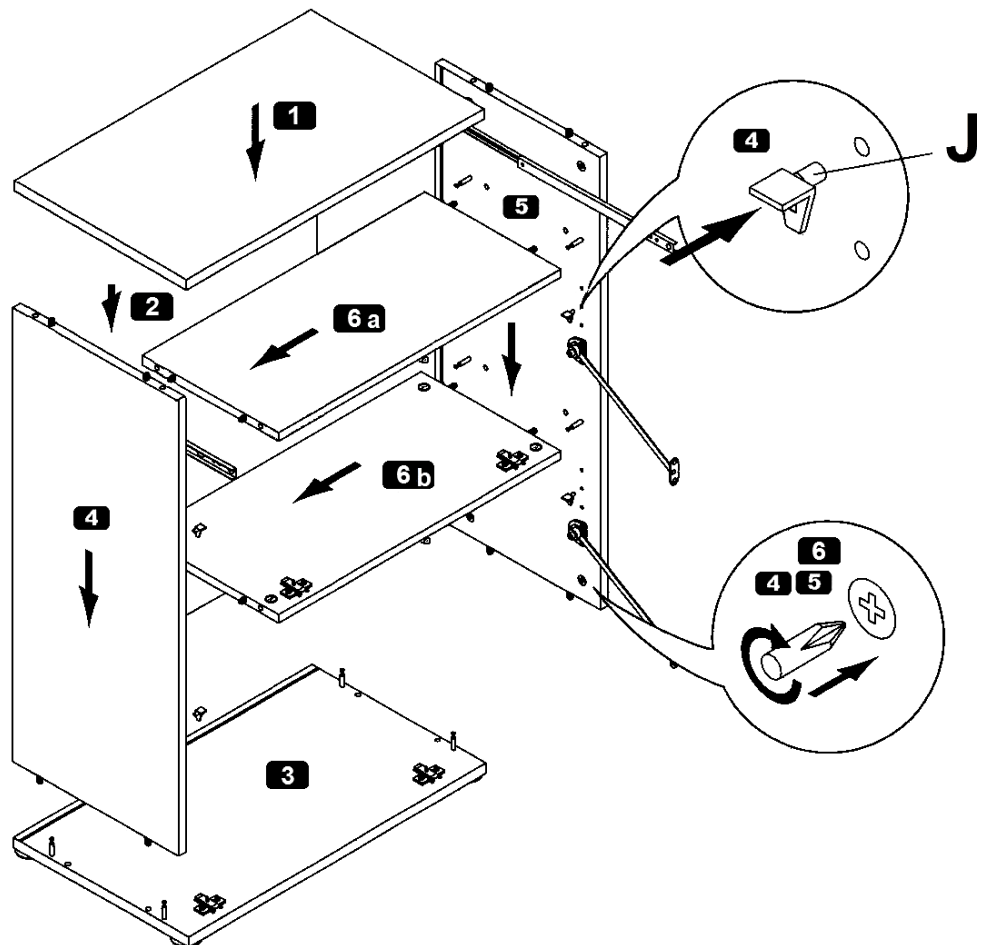
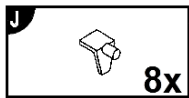

5

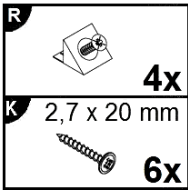

- (D) Wichtig! Bitte genau hier anbringen!
- (GB) Important! Please attach right here!
- (FR) Important! Veuillez joindre ici!
- (RU) Важно! Пожалуйста, прикрепите прямо здесь!
- (TR) Önemli! Lütfen buraya ekleyin!
- (IT) ! importante Si prega di allegare proprio qui!
- (NL) Belangrijk! Voeg hier toe!
- (PL) Ważne! Dołącz tutaj!
- (CZ) Důležité! Připojte se prosím zde!
- (RO) Important! Vă rugăm să atașați chiar aici!
- (HU) Fontos! Kérjük, csatolja ide!
- (SK) Dôležité! Pripojte, prosím, tu!

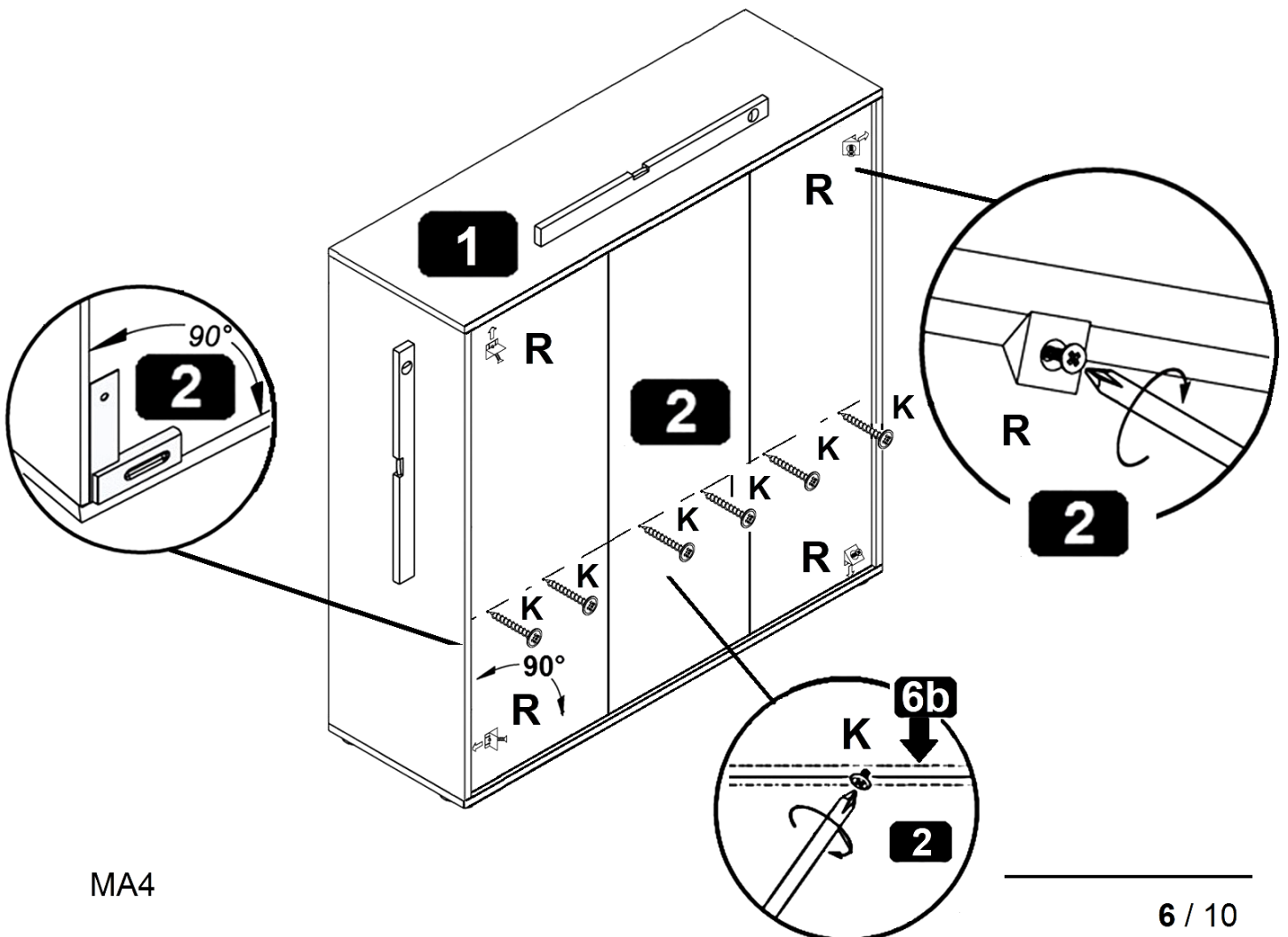

6

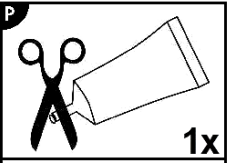

- D Leim
- GB Glue
- FR Colle
- IT Colla
- NL Lijm
- PL Klej
- CZ Lepidlo
- SK Glej
- HU Enyv
- RO Adeziv
- TR Tutkal
- RU Клей

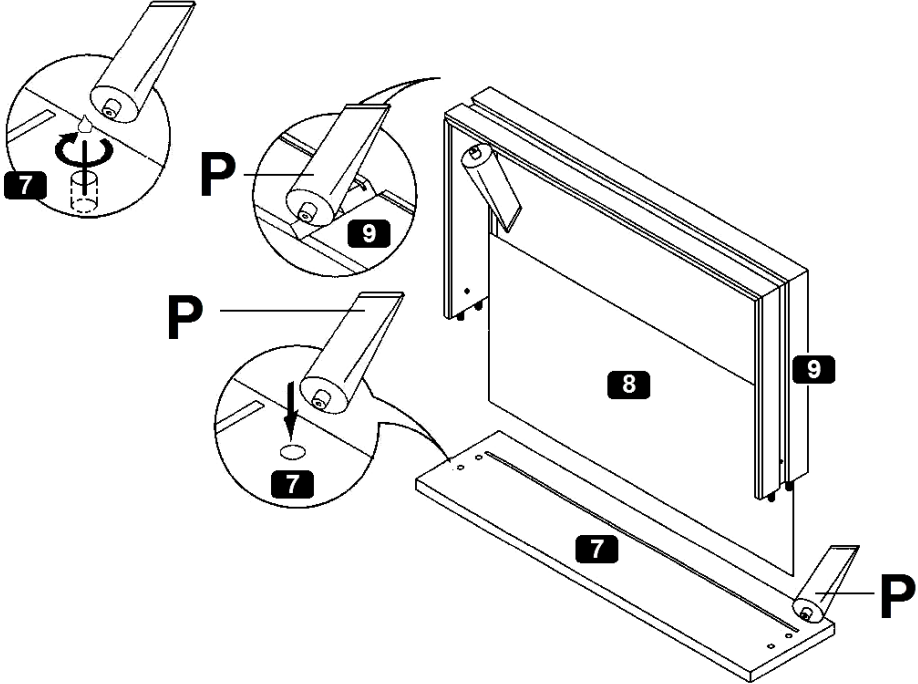

7

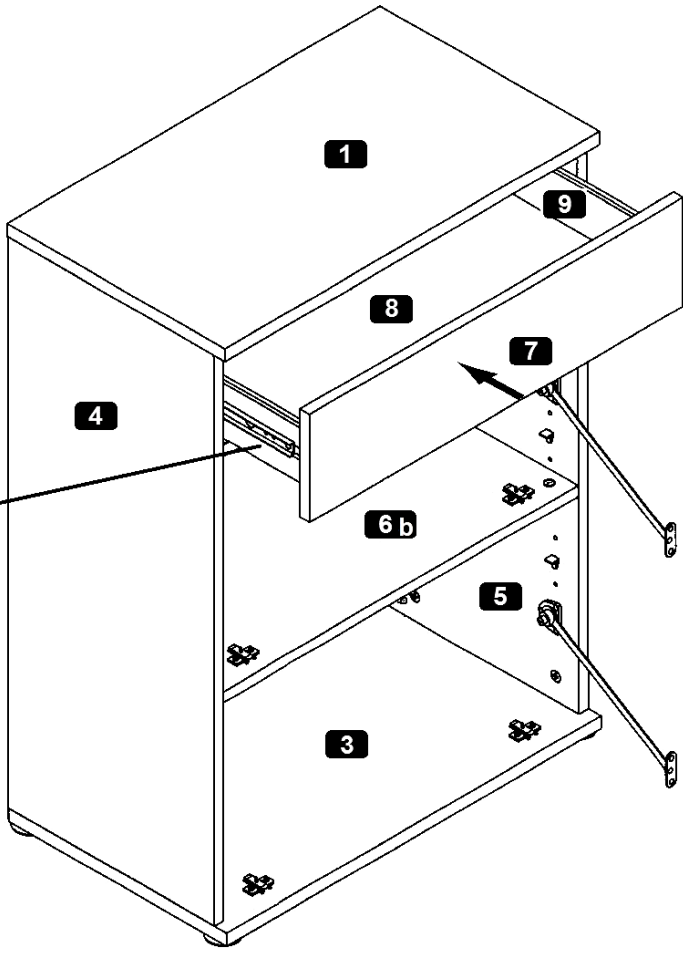
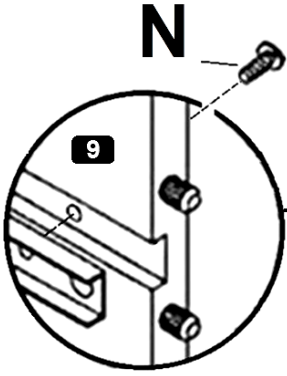
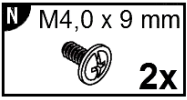

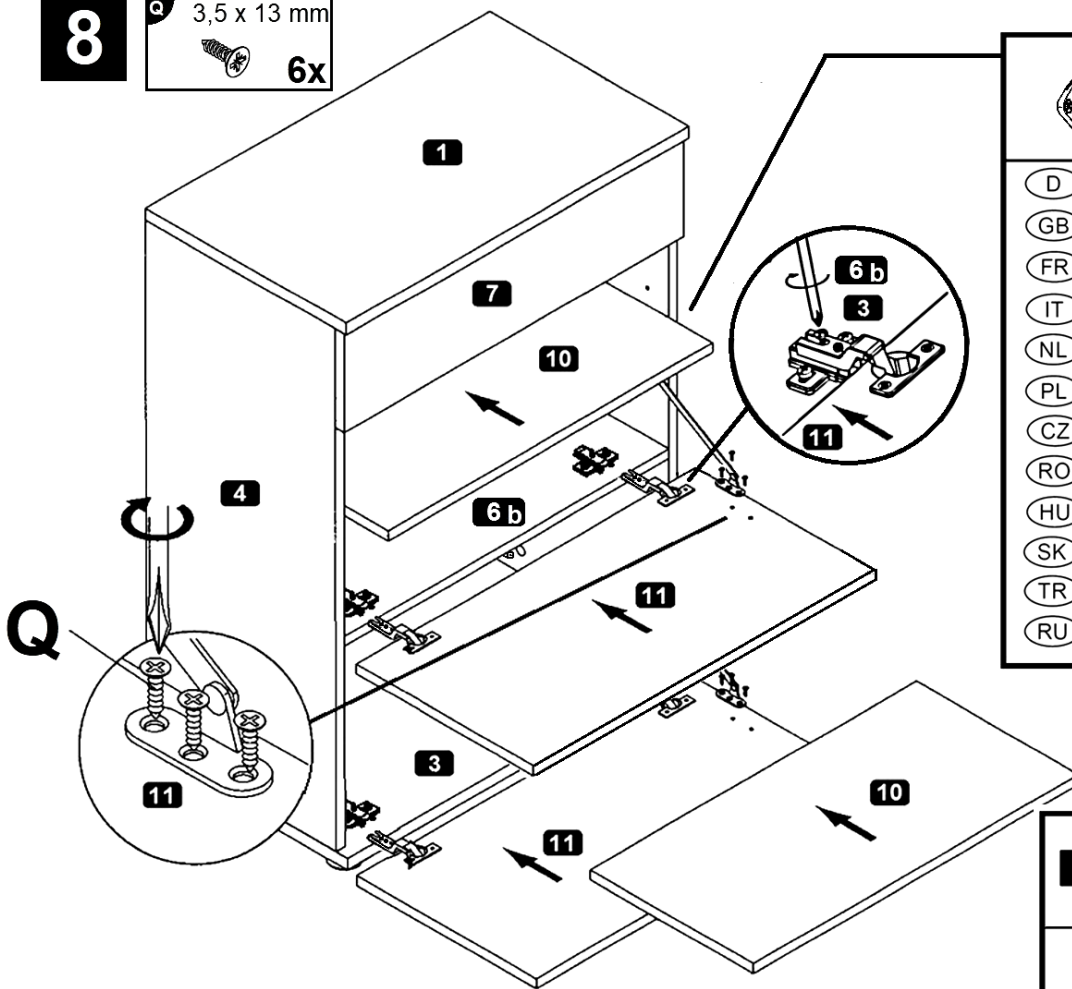

8 3,5 x 13 mm
6x





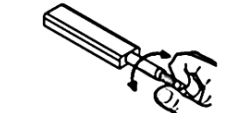

(D) Bremskraft einstellen
(GB) Adjust braking force
(FR) Ajuster la force de freinage
(IT) Regolare la forza frenante
(NL) Remkracht aanpassen:
(PL) Dostosuj siłę hamowania
(CZ) Seřid'te brzdnou sílu
(RO) Reglați forța de frânare
(HU) Állítsa be a fékerőt
(SK) Nastavte brzdnú silu
(TR) Fren kuvvetini ayarlayın
(RU) Отрегулируйте тормозное усилие

➔ **9 / 10** 

(D) Push-To-Open einstellen
(GB) Adjusting the Push-To-Open
(FR) Régler les Push-To-Open
(IT) Sistemare Push-To-Open
(NL) Push-To-Open instellen
(PL) Nastawić Push-To-Open
(CZ) Vyrovnajte Push-To-Open
(RO) Nastavenie Push-To-Open
(HU) Állítsa be az Push-To-Open
(SK) Reglare Push-To-Open
(TR) Push-To-Open ayarlanması
(RU) Регулировка Push-To-Open

➔ **10 / 10** 

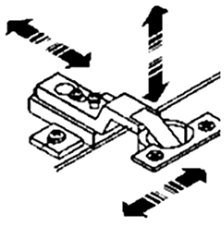
(NL) Deuren instellen (scharnieren afstellen)
(PL) Nastawić drzwi (wyregulować zawiasy)
(CZ) Vyrovnajte dvířka (seřid'te závěsy)
(RO) Nastavenie dverí (nastavenie závesov)
(HU) Állítsa be az ajtókat (állítsa be a zsanérokot)
(TR) Reglare uși (ajustare balamale)
(SK) Kapíların ayarlanması (menteşelerin seviye ayarı)
(RU) Регулировка дверей (регулировка шарнира)

(D) Türen einstellen (Scharniere justieren)
(GB) Adjusting the doors (adjusting the hinges)
(FR) Régler les portes (ajuster les charnières)
(IT) Sistemare le porte (regolare le cerniere)

9

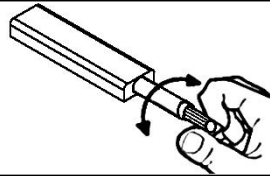

(D) Push-To-Open einstellen

(GB) Adjusting the Push-To-Open

(FR) Régler les Push-To-Open

(IT) Sistemare Push-To-Open

(NL) Push-To-Open instellen

(PL) Nastawić Push-To-Open

(CZ) Vyrovnajte Push-To-Open

(RO) Nastavenie Push-To-Open

(HU) Állítsa be az Push-To-Open

(SK) Reglare Push-To-Open

(TR) Push-To-Open ayarlanması

(RU) Регулировка Push-To-Open

1.

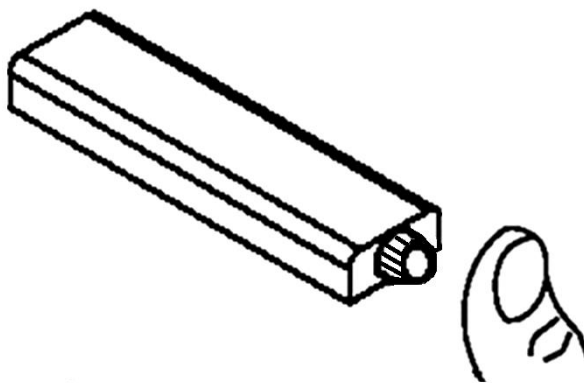

2.

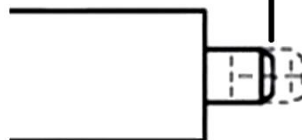
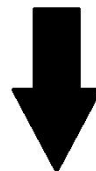
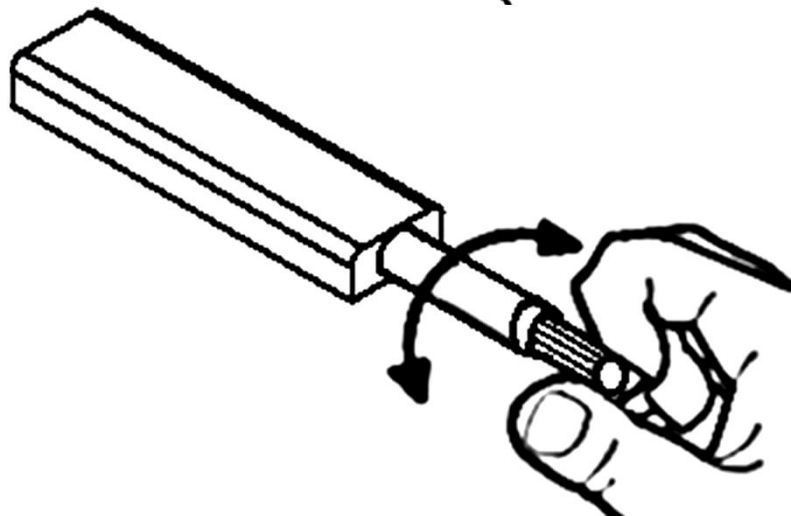

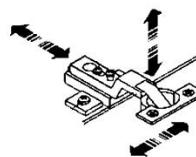

(D) Türen einstellen
(Scharniere justieren)

(GB) Adjusting the doors
(adjusting the hinges)

(FR) Régler les portes
(ajuster les charnières)

(IT) Sistemare le porte
(regolare le cerniere)

(NL) Deuren instellen
(scharnieren afstellen)

(PL) Nastawić drzwi
(wyregulować zawiasy)

(CZ) Vyrovnajte dvířka
(seřid'ťe závěsy)

(RO) Nastavenie dverí
(nastavenie závesov)

(HU) Állítsa be az ajtókat
(állítsa be a zsanérokat)

(SK) Reglare uši
(ajustare balamale)

(TR) Kapıların ayarlanması
(mentşelerin seviye ayarı)

(RU) Регулировка дверей
(регулировка шарнира)

