

Z	J	B	Y
8x	4x	12x	12x

»BANDOS«



06/15

- | | |
|---|-------------------------------------|
| (D) Montageanleitung | (GB) Assembly instructions |
| (NL) Handleiding voor de montage | (PL) Instrukcja montażu |
| (TR) Montaj talimat | (RU) Инструкция по монтажу |
| (RO) Instrucțiuni de instalare | (IT) Istruzioni di montaggio |
| (FR) Notice de montage | (SK) Montážny návod |
| (CZ) Montážní návod | (HU) Szerelési útmutató |

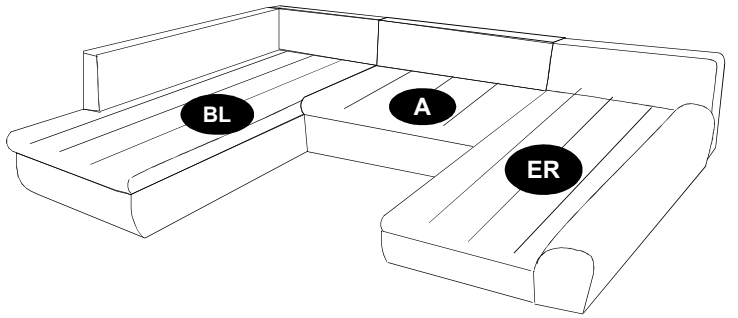
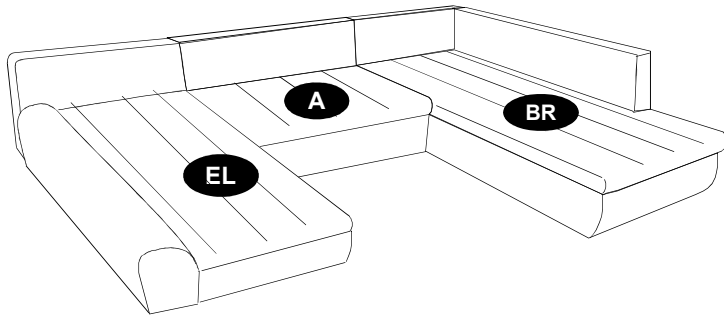

1

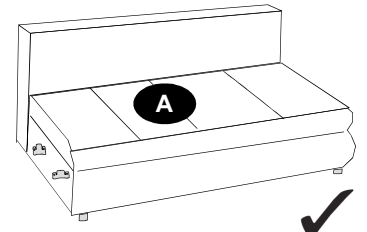
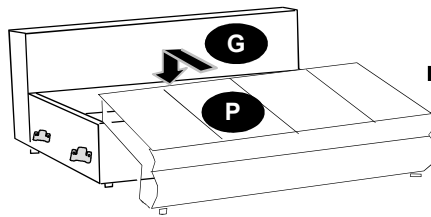
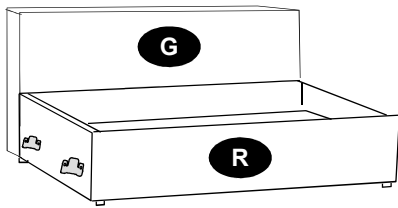

2

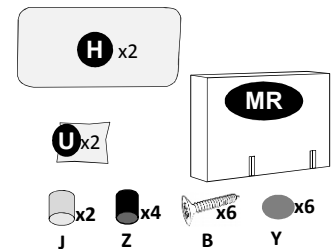
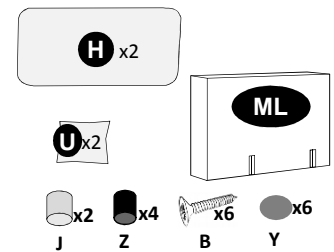
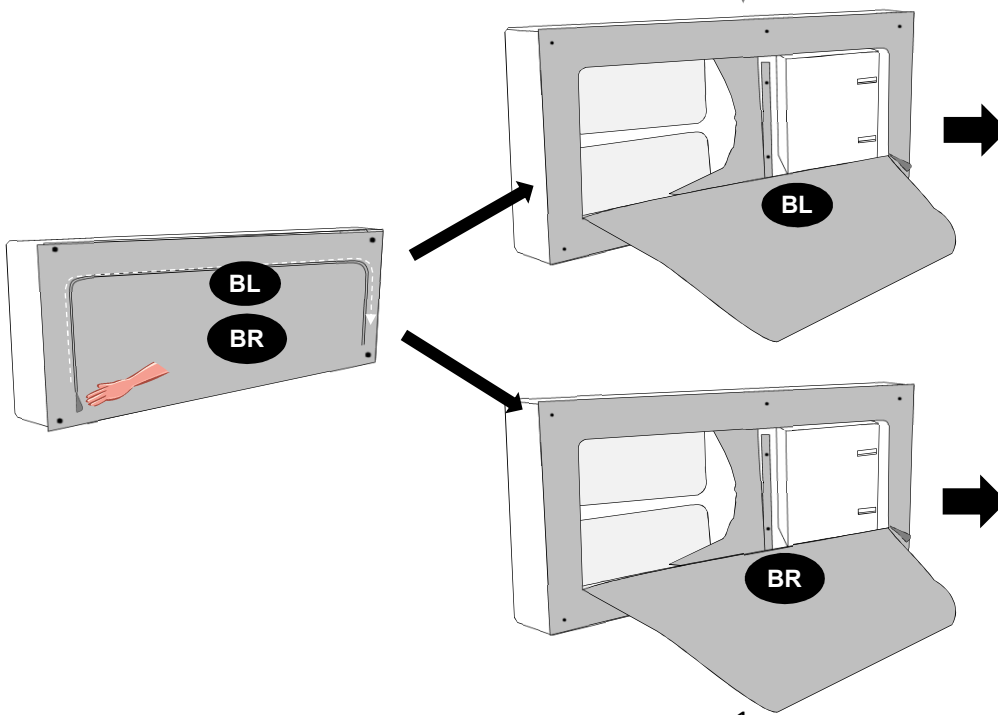

1



3

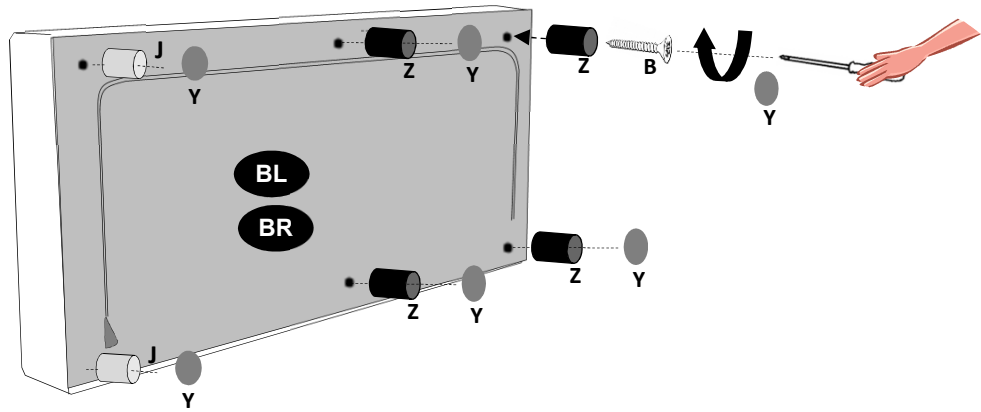

4

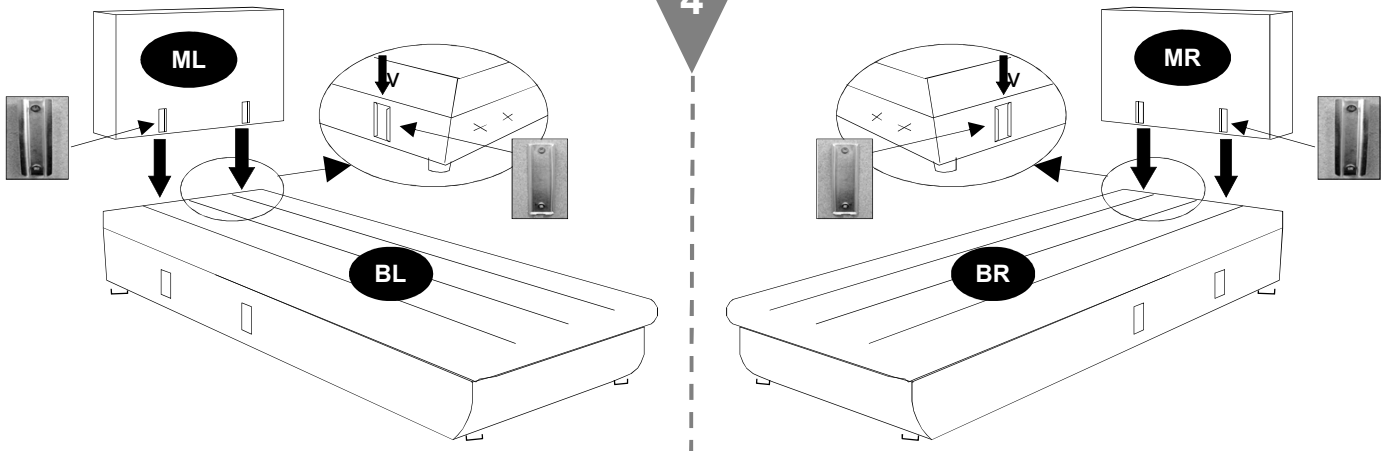

5

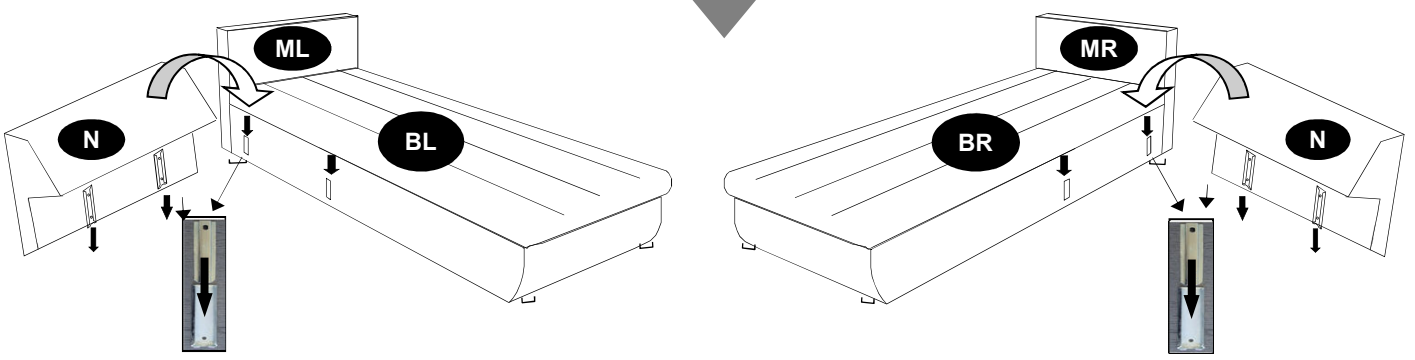

6

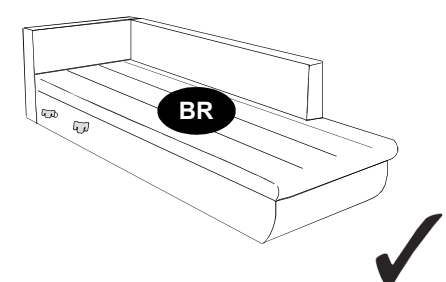
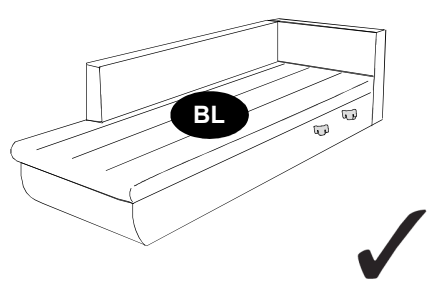



7

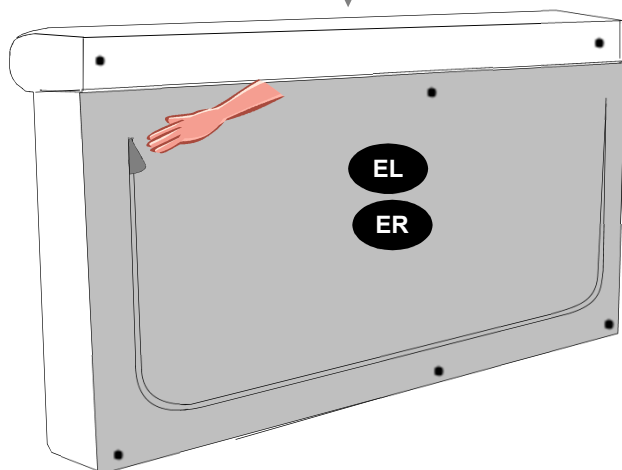

8

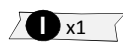
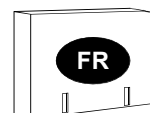
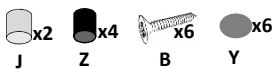
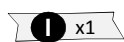
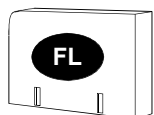
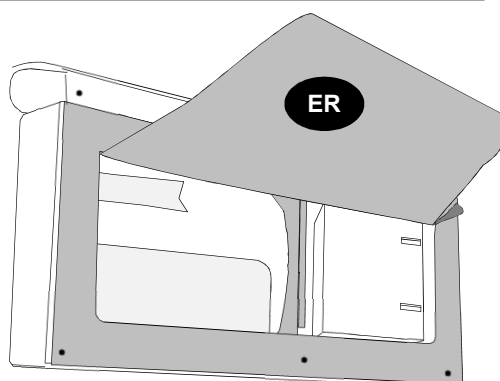
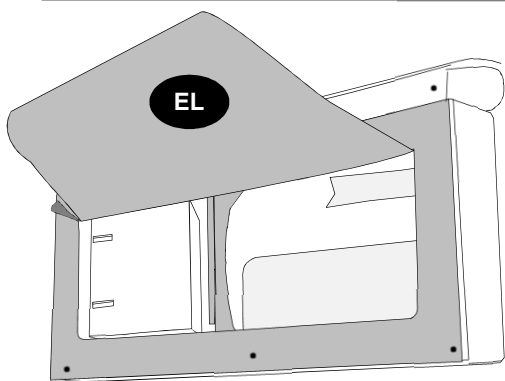

9

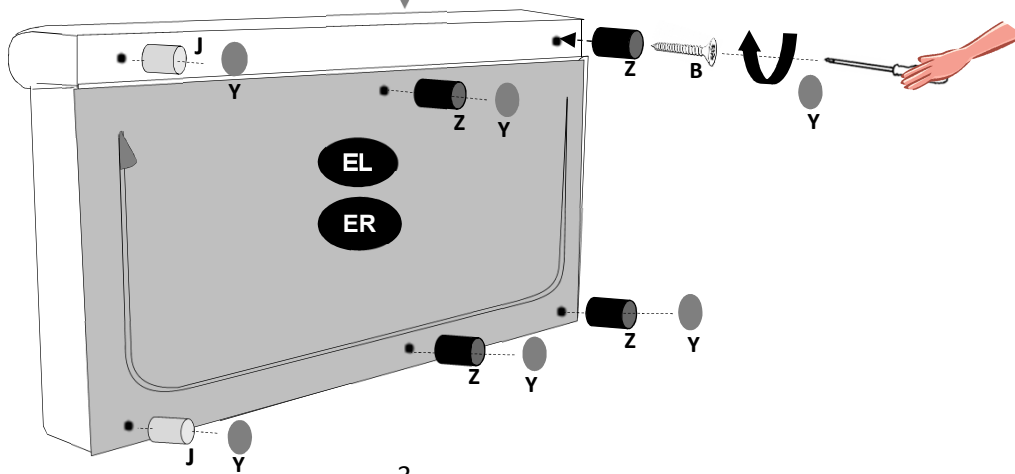



10

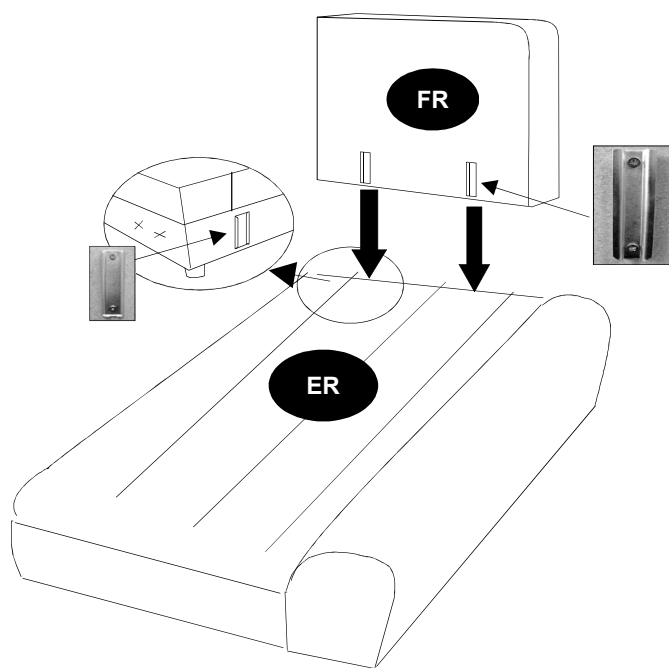
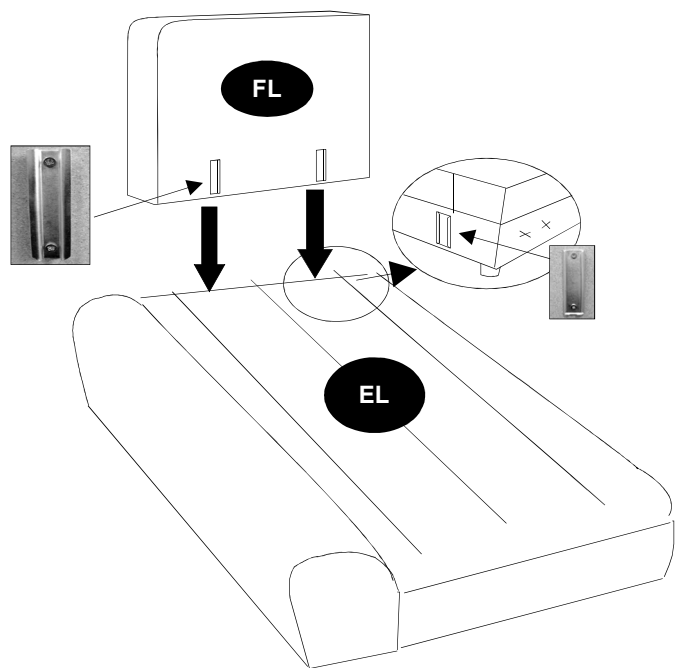

11

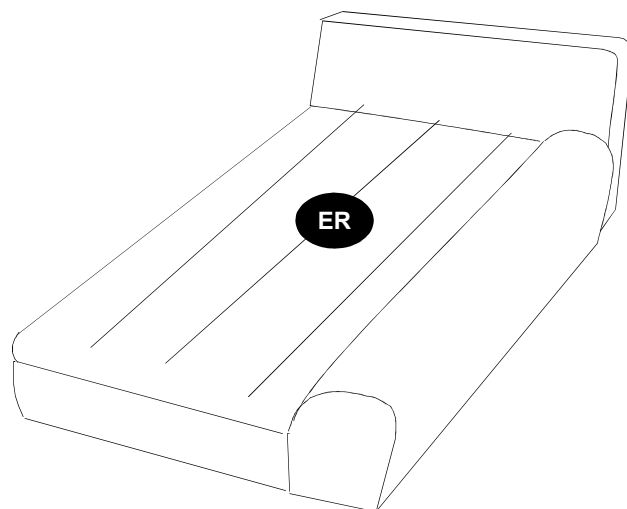
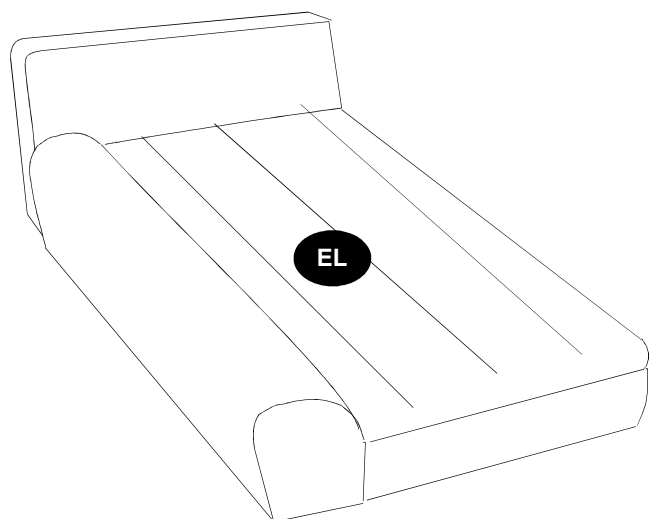

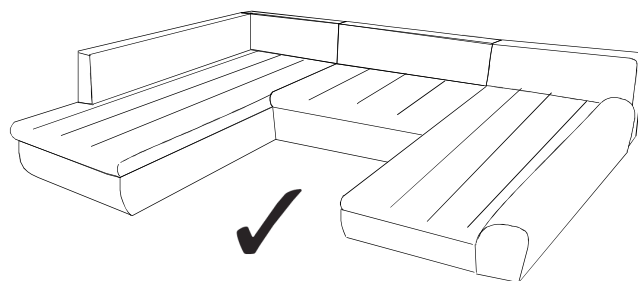
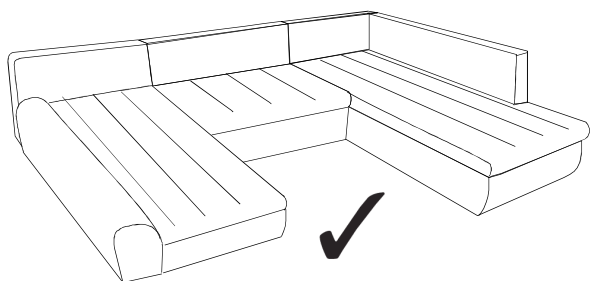
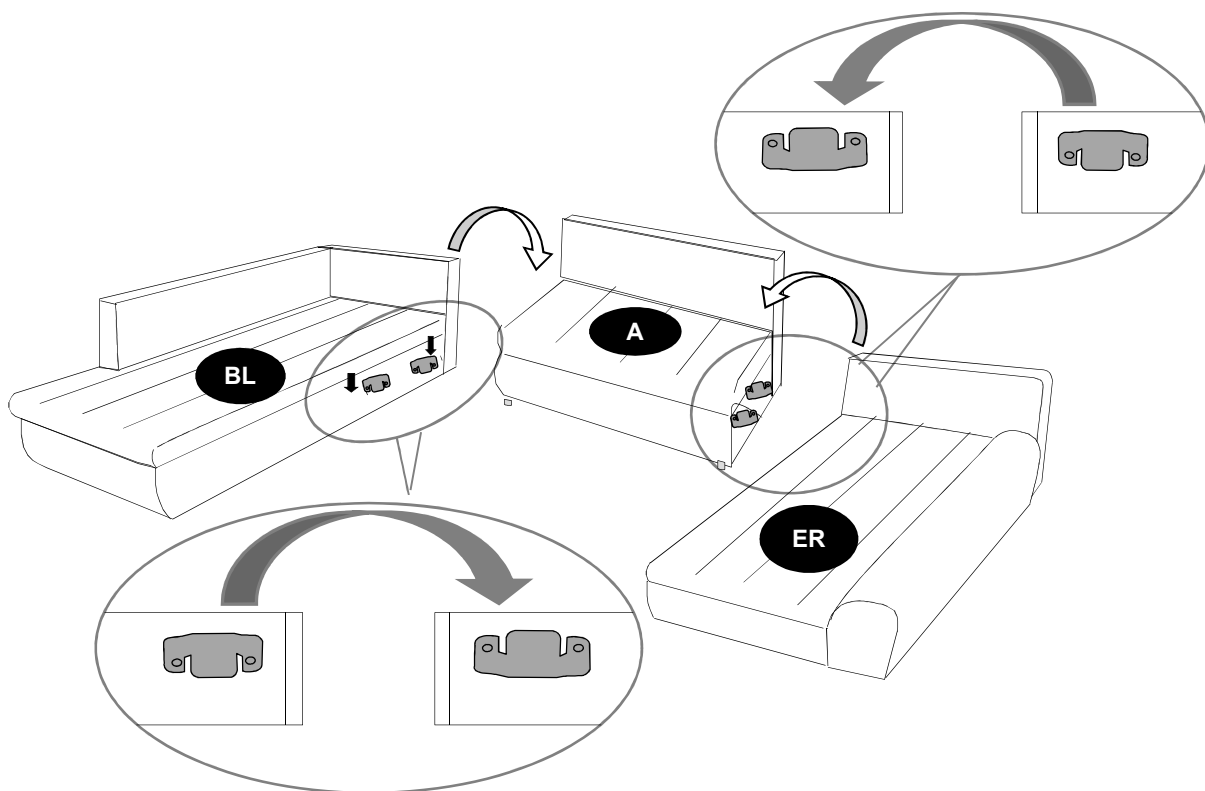
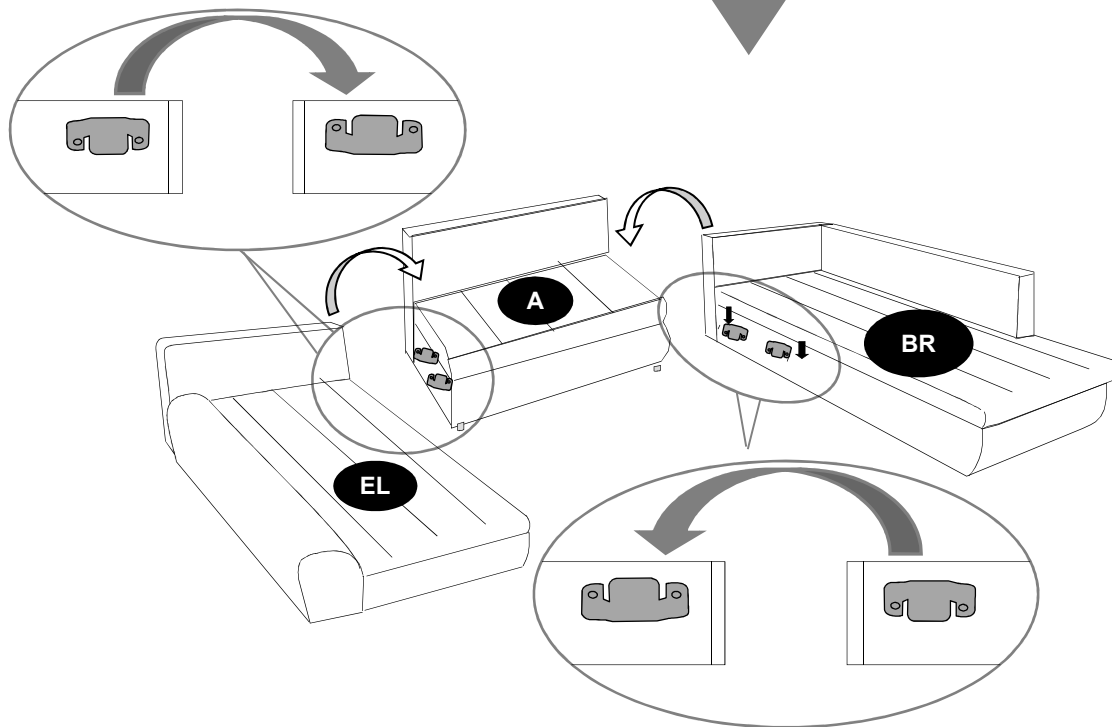

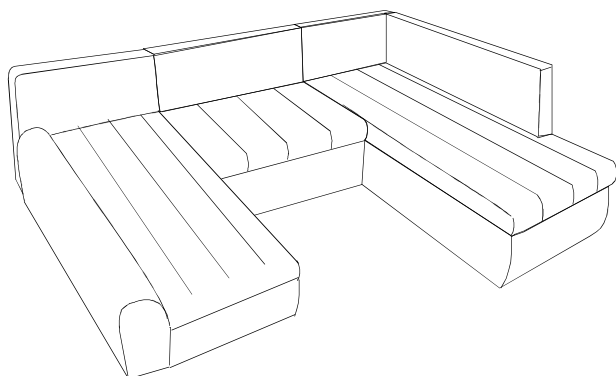
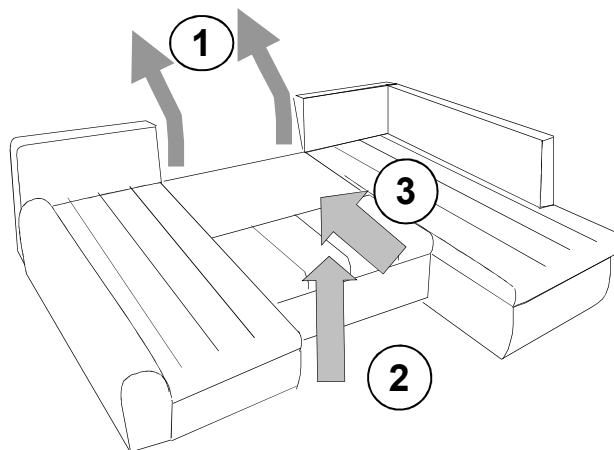
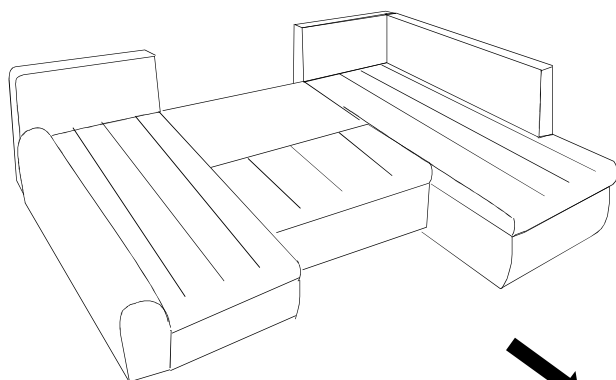
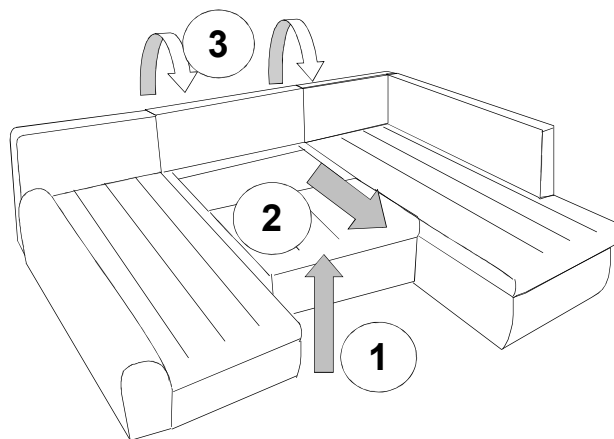
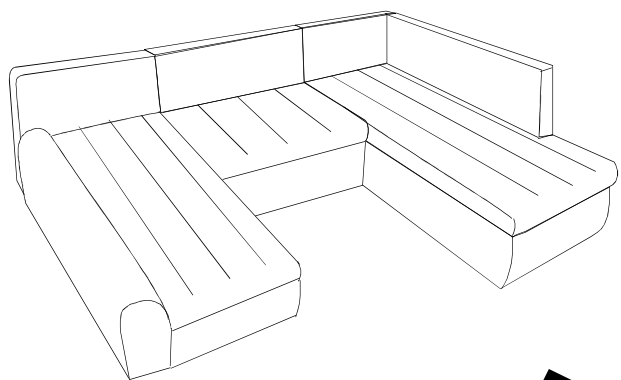

Service · Dienstverlening · Serwis · Servis · Сервисная служба · Serviciu · Servizio
 · Služby · Szolgáltatás

Name · Naam · Nazwa · İsim · Название · Nume · Nome ·
 Názov · Název · Neve

BANDOS U-form

Nr. · No · Номер · Nu · Nombre · Číslo · Száma

Typ · Type · Tip · Тип · Tipo · Típus

xyz

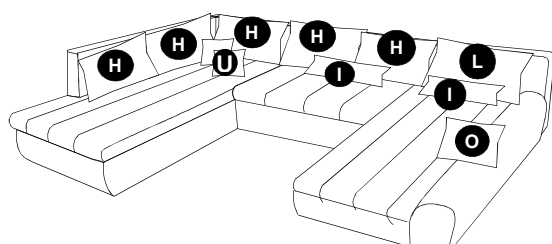
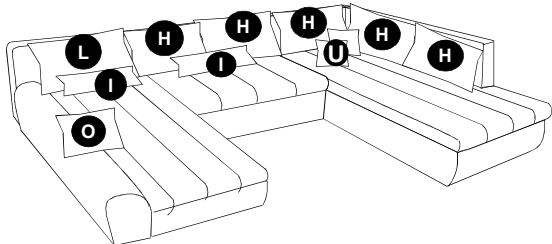
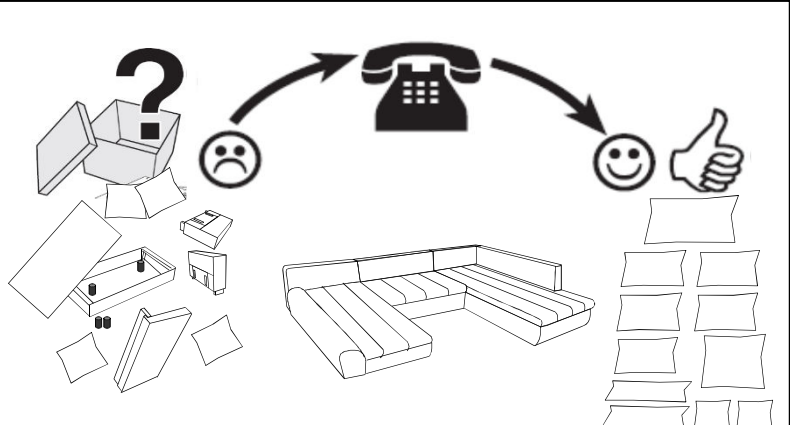

Z	J	B	Y
12x	6x	18x	18x

- L x1
- H x5
- O x1
- I x2
- U x2

