

Mirco



D Montageanleitung

GB Assembly instructions

FR Notice de montage

NL Handleiding voor de montage

CZ Montážní návod

IT Istruzioni di montaggio

RO Instrucțiuni de montaj

RU инструкция по сборке

PL Instrukcja montażu

SK Návod na montáž

HU Szerelési útmutató

TR Montaj talimatı

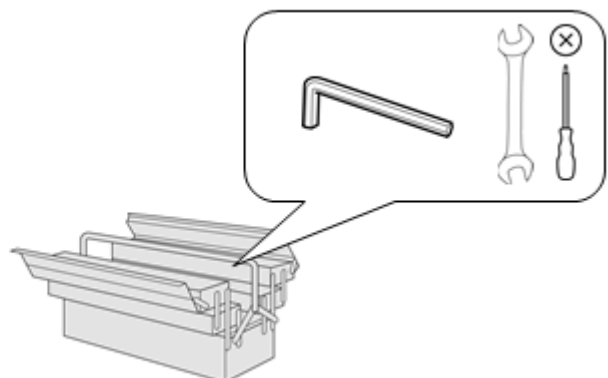
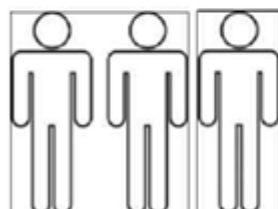

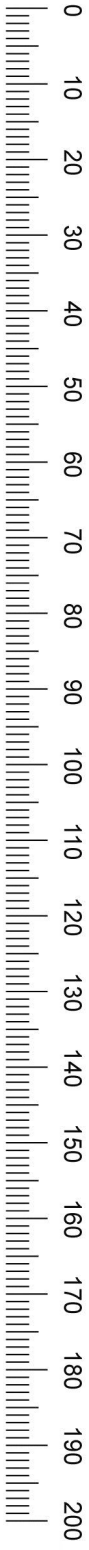

**Service • Assistenza • Dienstverlening • Serwis
Servis • Szerviz • Сервисная служба**

Name • Nom • Nome • Naam Nazwa • Jméno • Názov • Név Denumire • İsim • Название	Mirco zerl.
Nr. • No. • N° • Номер • Č • Sz	
Typ • Type • Tip • Típus • Тип	FEPO

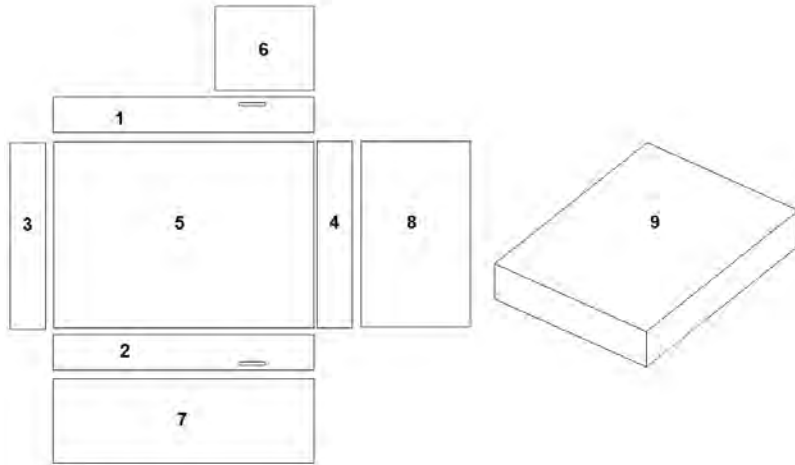
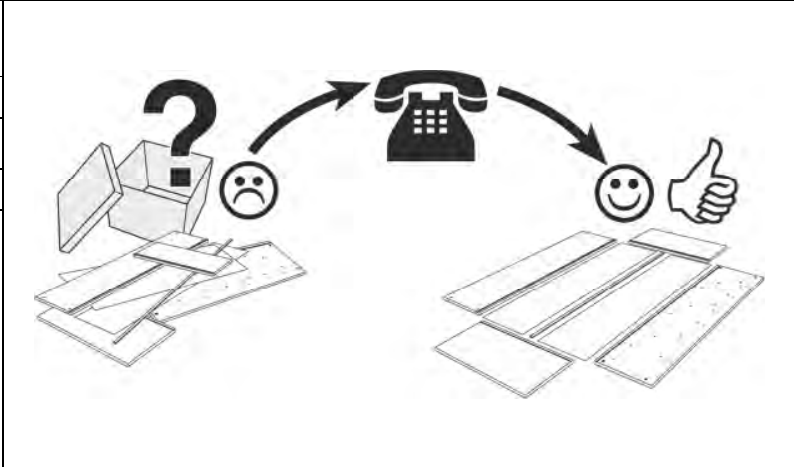
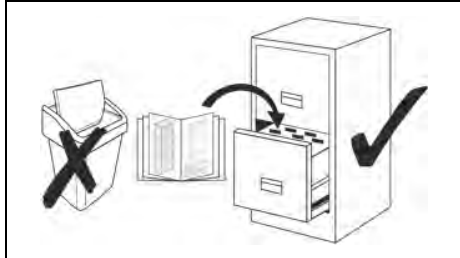

A	B	C	D	E	F	G	H
4x	16x 6x20	4x	4x 6x35	4x	4x 6x35	4x M6	4x M6
I	J	K	L	M	N	O	P
4x M6	2x	2x 5x16	2x M5	2x M5	2x 4,5x20	1 Paar	2x
			T				
			4x 6x20				

1. Montage Bettseiten(1+2)

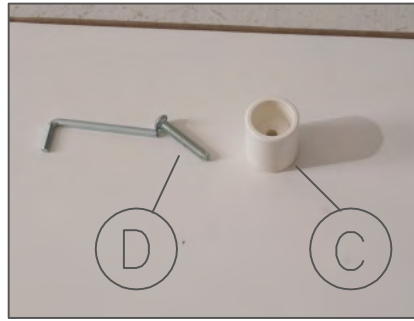
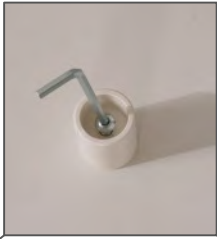

1

Links

2

Rechts

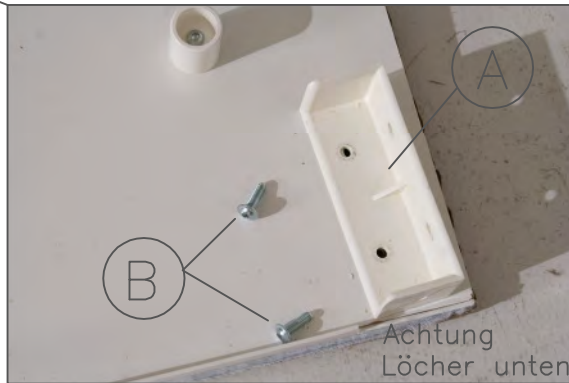

!!! HANDFEST MONTIEREN !!!

Fertig montiert

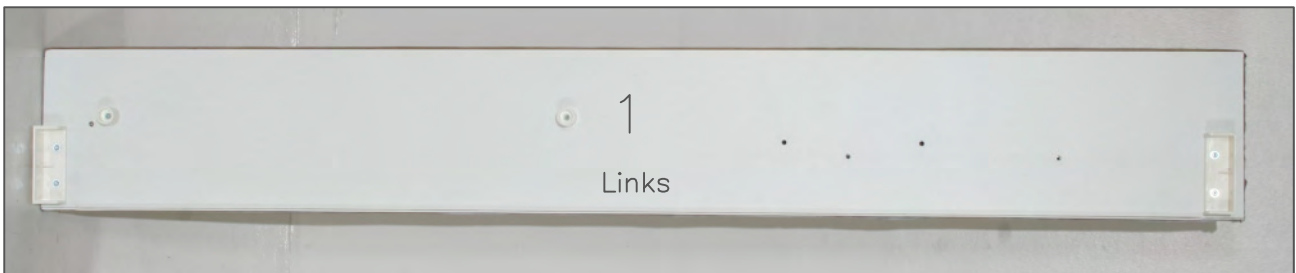

2. Bettkopfteil(4) mit Bettseiten(1+2) verbinden



3. Bodenplatte(5) einschieben



6. Fußteil(3) montieren



7. Bodenplatte fixieren

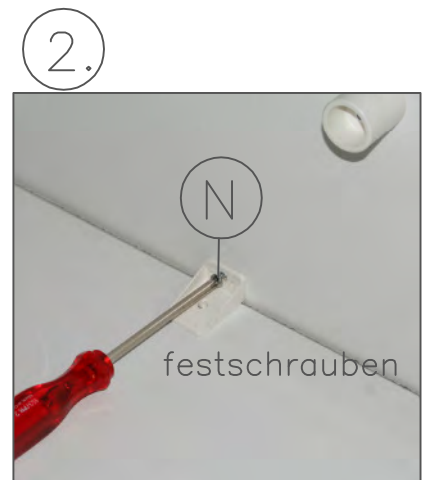
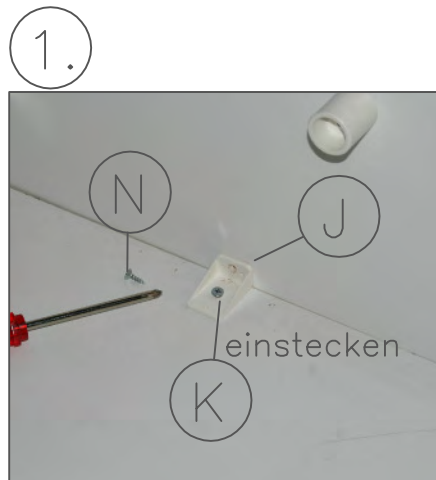

3. Bettkasten auf Seite stellen

Ansicht:
Unten

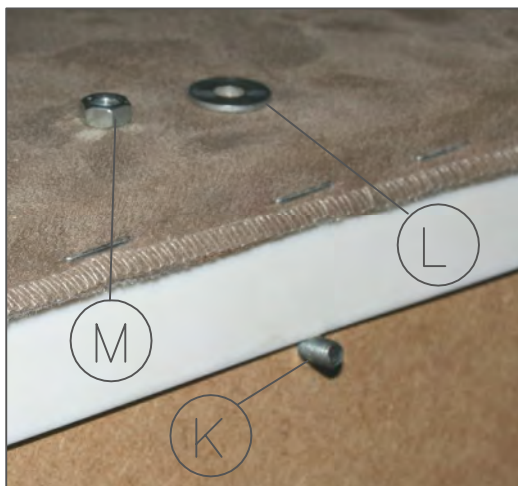

6. FüÙe(E) montieren



1.

Außen

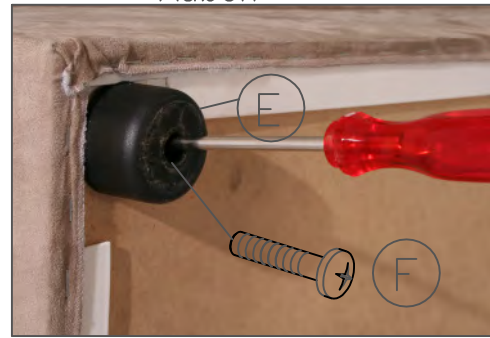

Innen



2.

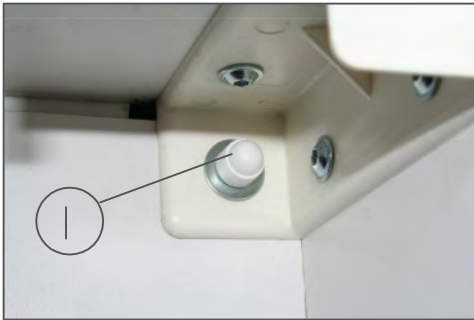

7. BeschläÙe(0) an LiegefläÙe(7) schrauben

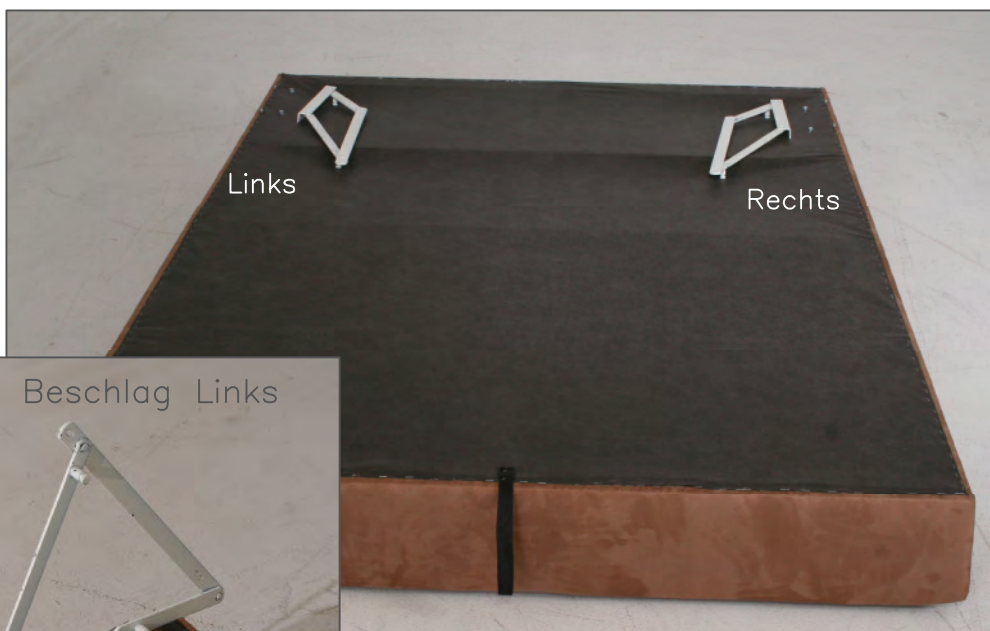

8. Liegefläche an Bettkasten montieren



9. Bett schließen und auf FüÙe stellen

1.



2.



10. Federn(P) in Beschlage(O) einhangen

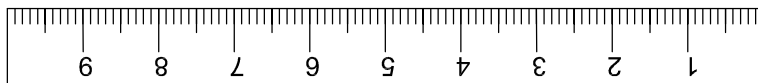
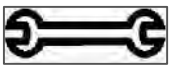

Montageanleitung
 Assembling Instruction
 Montageaanwijzing



Die Formen der Bauteile können von dieser Zeichnung abweichen.

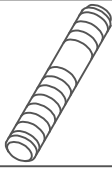

Shapes of individual parts may vary from drawing.

De vormen van bouwdeelen kunnen van deze tekening afwijken.

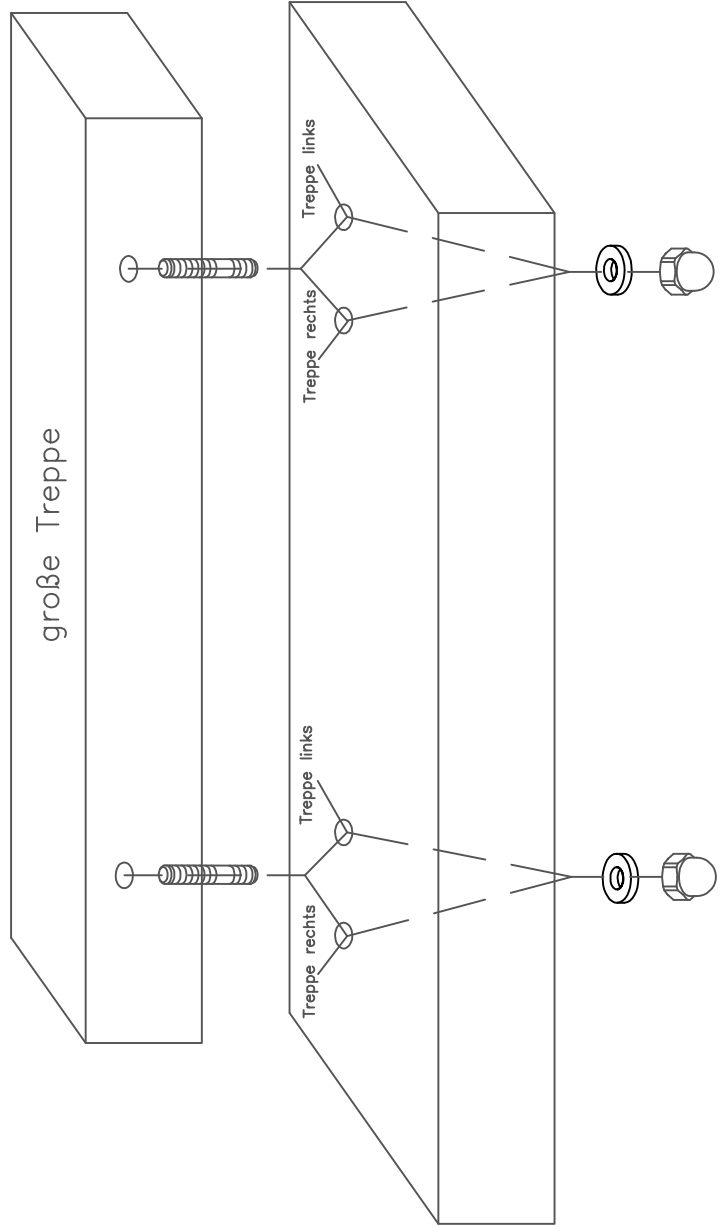
A		B		C	
	2x M8x45		2x M8		2x M8

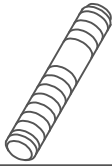
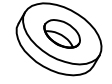

Montageanleitung
Assembling Instruction
Montageaanwijzing

A	B	C
		
*4x M8x60 8x M8x45	12x M8	12x M8

Die Formen der Bauteile können von dieser Zeichnung abweichen.



Shapes of individual parts may vary from drawing.

De vormen van bouwdelen kunnen van deze tekening afwijken.

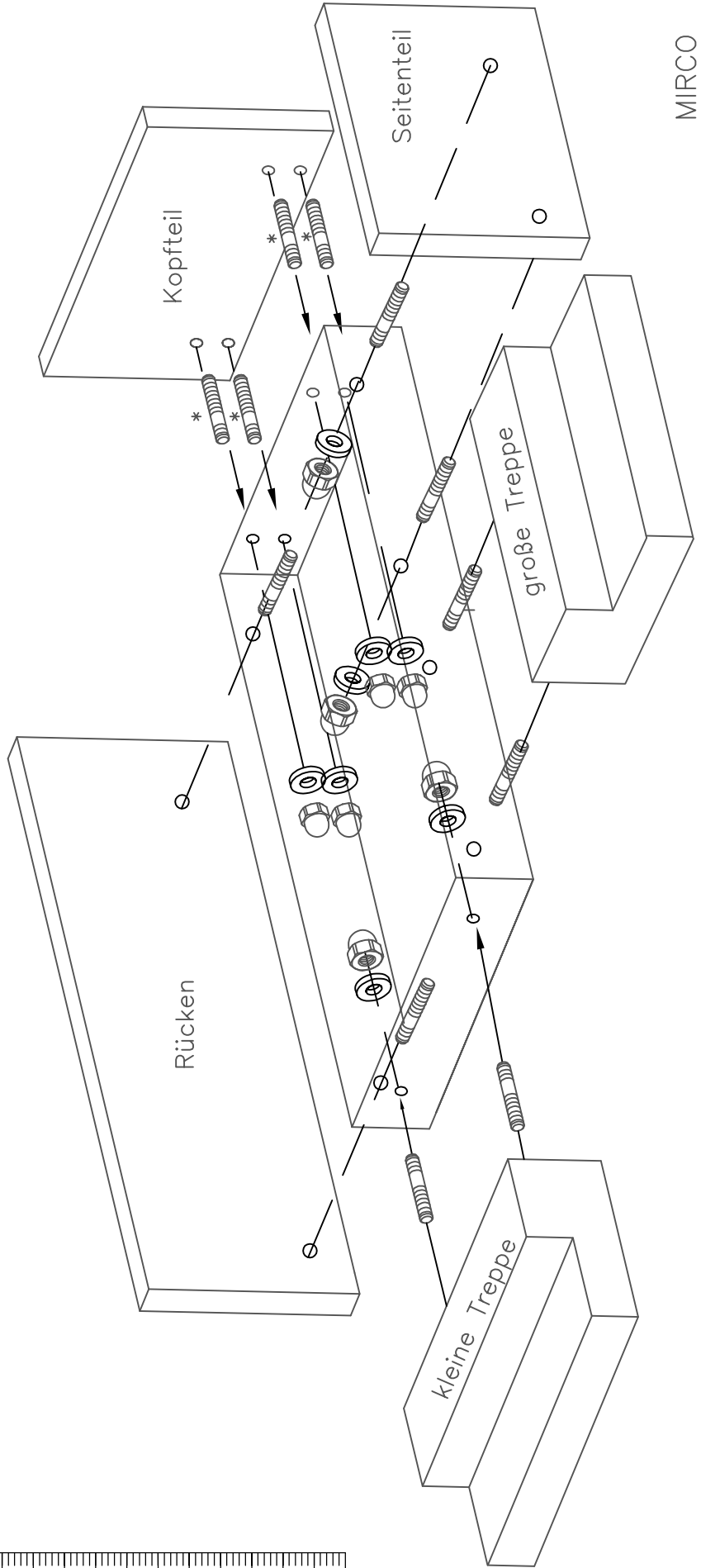
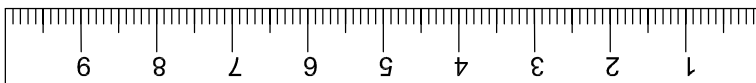
Treppe LINKS

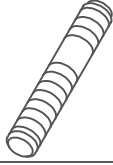

Montageanleitung
 Assembling Instruction
 Montageaanwijzing

A	B	C
		
*4x M8x60 8x M8x45	12x M8	12x M8

Die Formen der Bauteile können von dieser Zeichnung abweichen.

Shapes of individual parts may vary from drawing.

De vormen van bouwdelen kunnen van deze tekening afwijken.

Treppe RECHTS

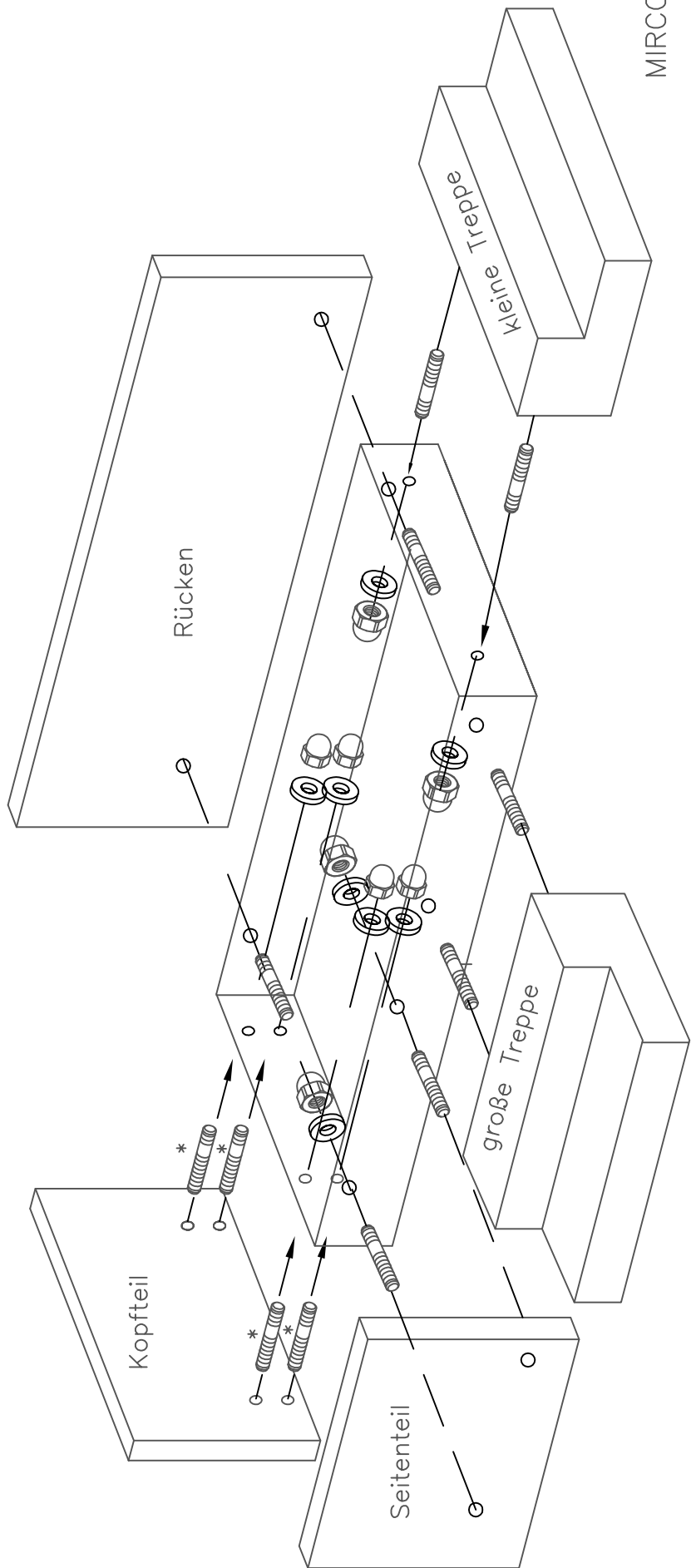
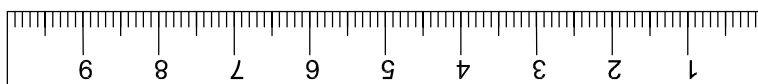

Montageschritte

1. Liegefläche öffnen



2. kleine Treppe montieren

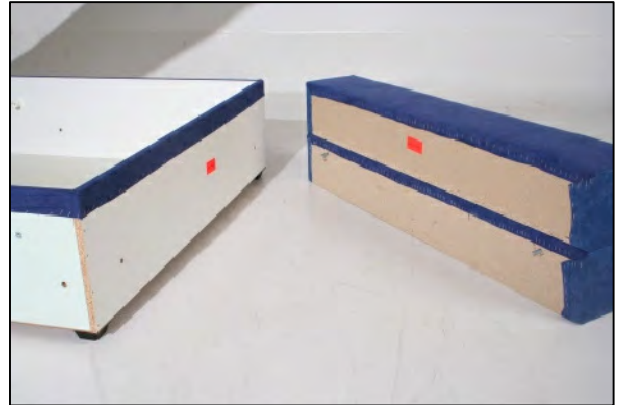

zu Schritt 2

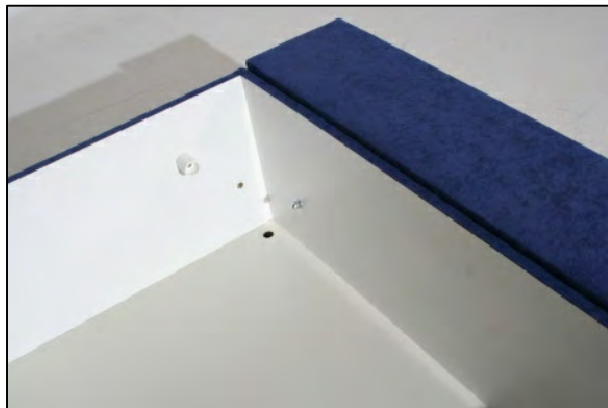

3. Kopfteil montieren



Treppe links

Treppe rechts

Rücken montieren



Seitenteil montieren



Treppe für Einstieg links oder rechts montieren

