

Montageanleitung

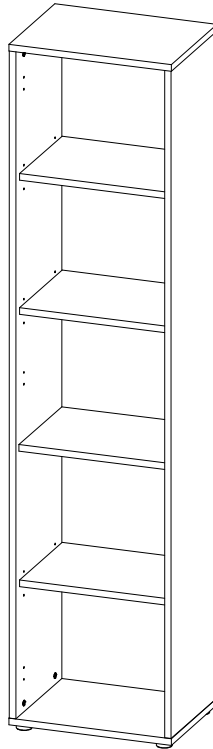

Sehr geehrte Kundin, sehr geehrter Kunde,
wir gratulieren Ihnen zum Erwerb Ihres neuen Möbelstückes.
Trotz größter Sorgfalt kann es aber vorkommen, dass in einem
Beschlagbeutel oder an einem Fertigungsteil ein Mangel ist.
Sollte dies bei Ihrem Möbelstück der Fall sein, kennzeichnen
Sie dieses deutlich auf der Skizze und geben Sie bitte die
fehlende Stückzahl an.

Für evtl. auftretende Rückfragen zum Artikel oder zur Montage
senden Sie uns bitte eine E-Mail:

support@bmg-moebel.de

Bitte lesen Sie diese Montageanleitung gut durch, da wir für
Fehler, die durch falsche Montage entstehen keine Haftung
übernehmen!

Office

Regal hoch - schmal

Für die Montage dieser Type benötigen Sie:

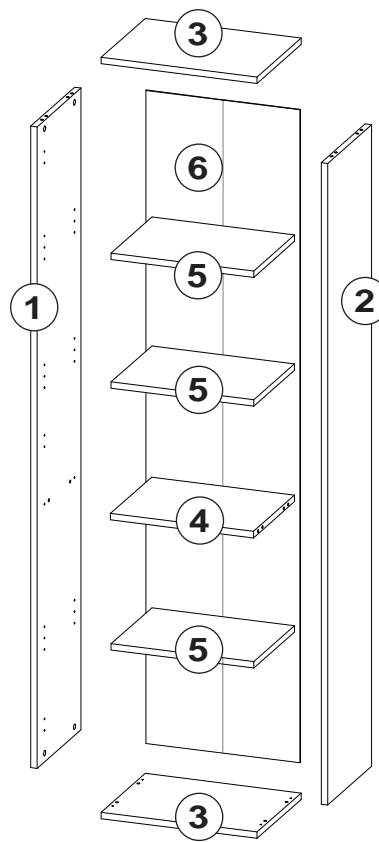
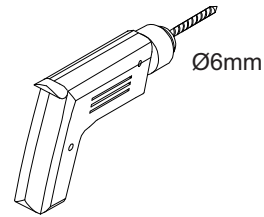
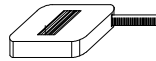
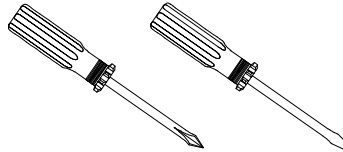
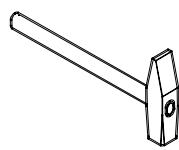
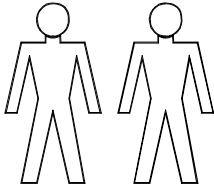

AA 12 Stück
Excenter

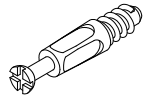

BD 12 Stück
Spannbolzen

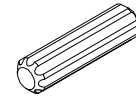

DA 12 Stück
Holzdübel 30mm



C 12 Stück
Bodenträger



H 50 Stück
Nagel



FU 4 Stück
Gleitfuß

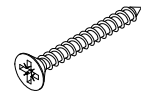

SB 4 Stück
Schraube 4,0x30



AK 12 Stück
Abdeckkappe

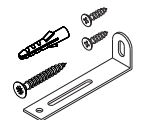

ZA 1 Stück
Befestigungssatz

Name

.....

Straße

.....

PLZ, Ort

.....

Telefon für Rückfragen

.....

E-Mail für Rückfragen

.....

Gekauft bei

.....

Datum

.....

1

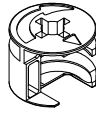
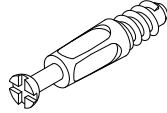
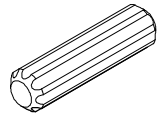
		
AA 12 Stück Excenter	BD 12 Stück Spannbolzen	DA 12 Stück Holzdübel 30mm

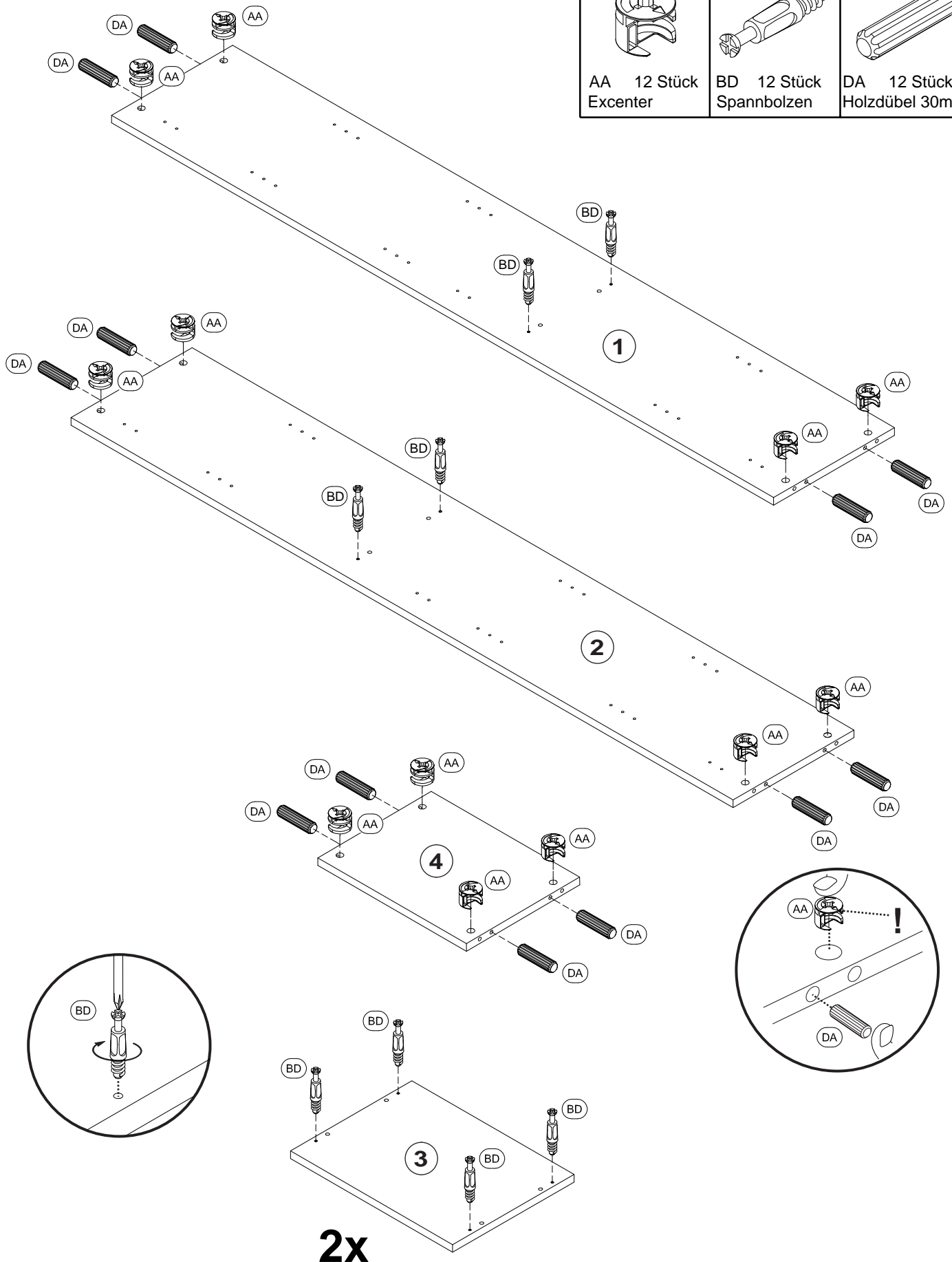

2

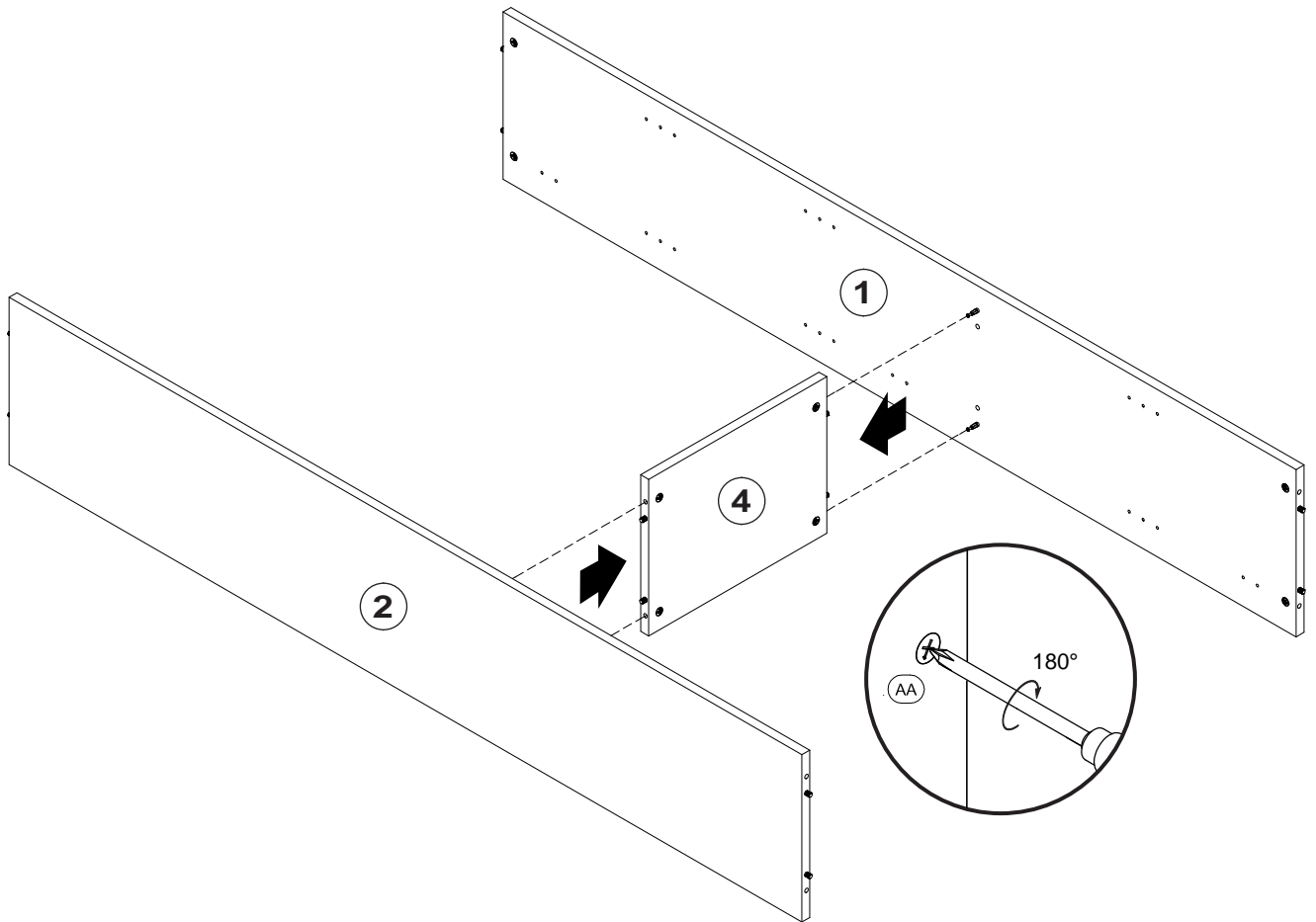

3

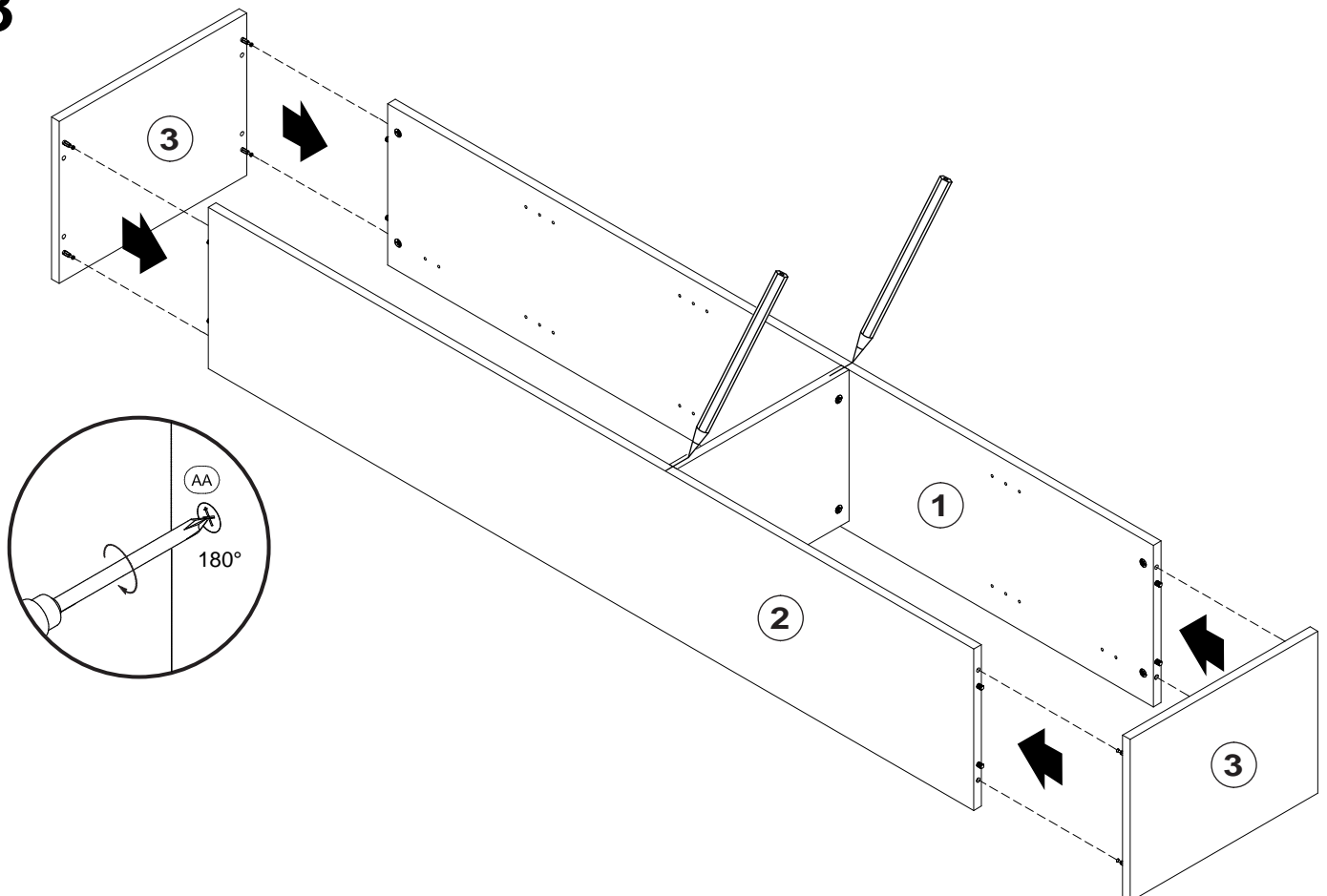

4

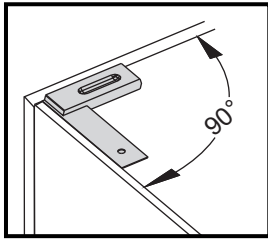

H 50 Stück Nagel	FU 4 Stück Gleitfuss	SB 4 Stück Schraube 4,0x30

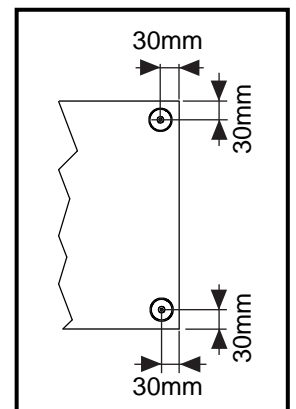
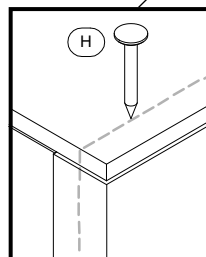
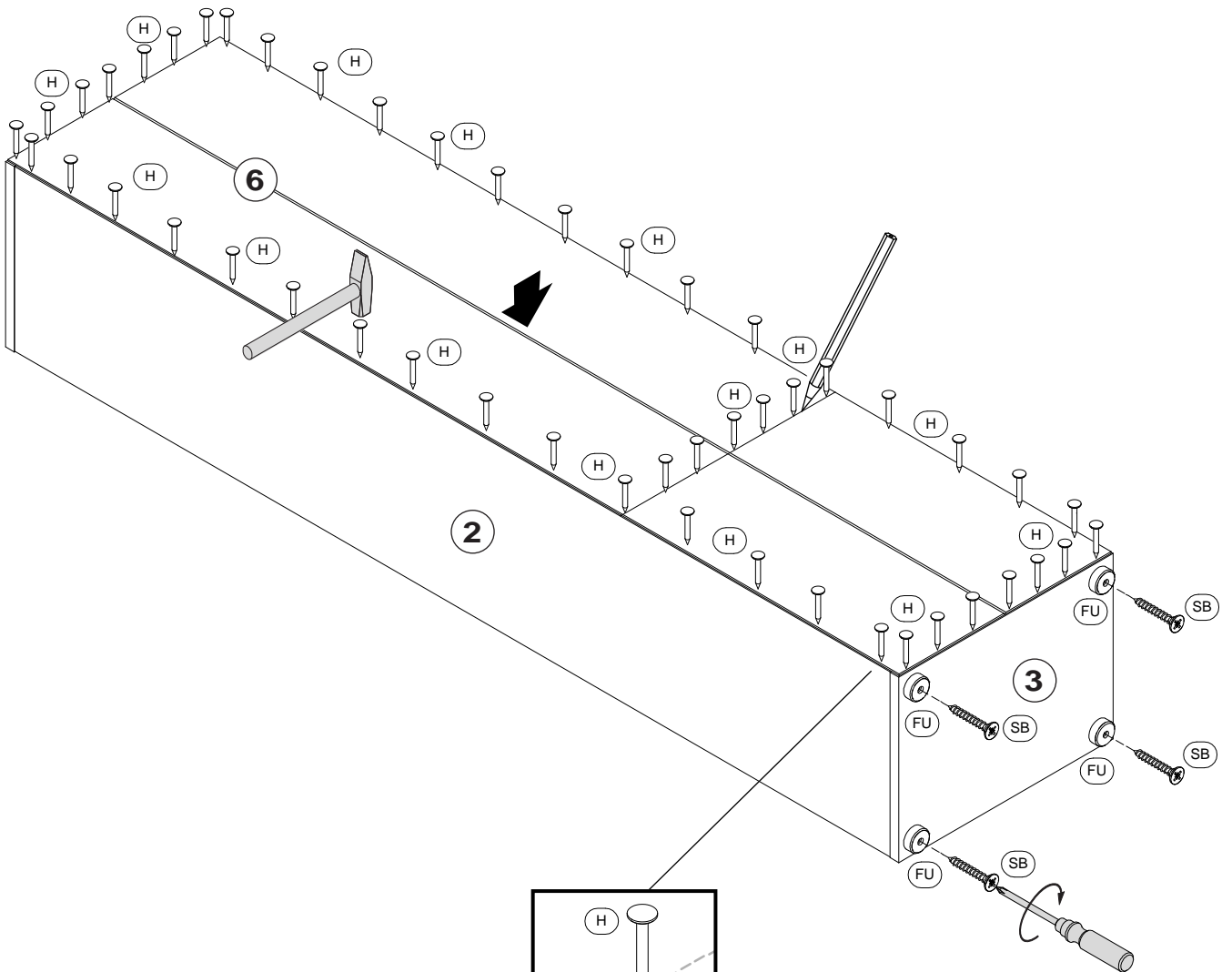

Office

Regal hoch - schmal

5



Achtung!
Wandbefestigung
zwingend erforderlich.

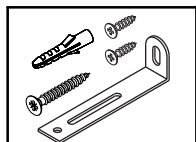

ZA 1 Stück
Befestigungssatz

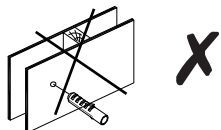
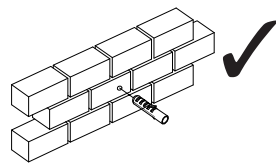

Ø6mm

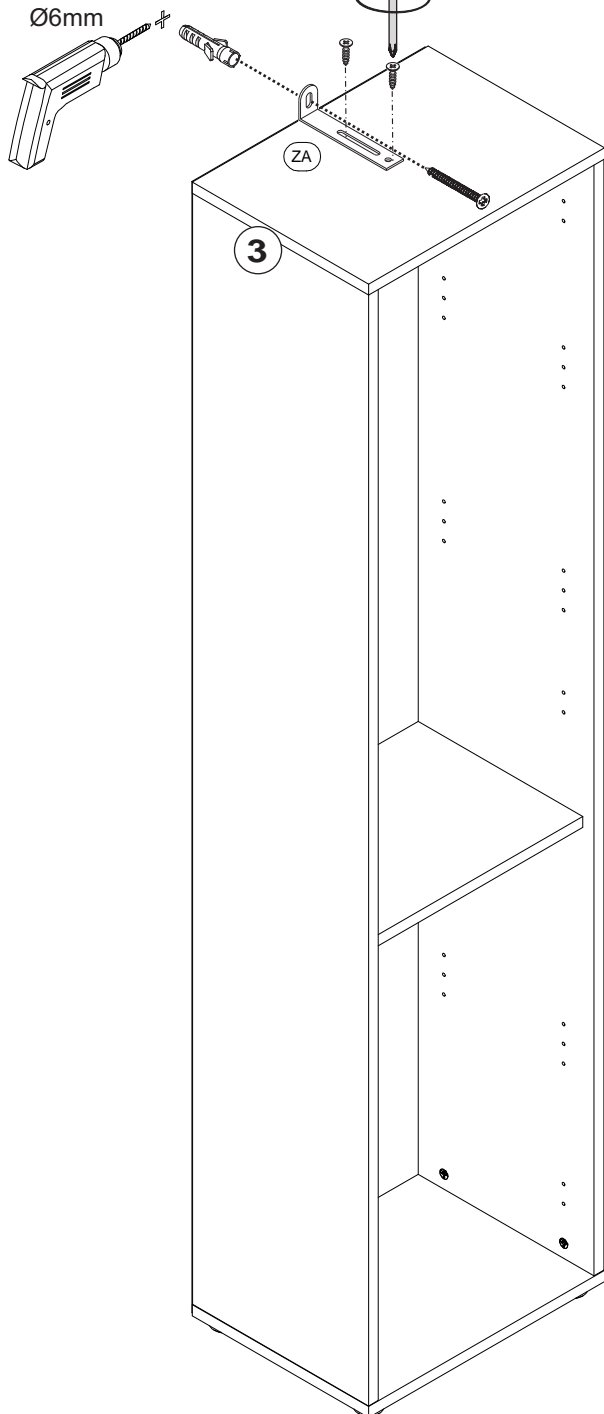

6



C 12 Stück
Bodenträger



AK 12 Stück
Abdeckkappe

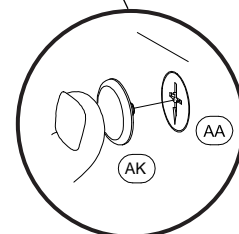
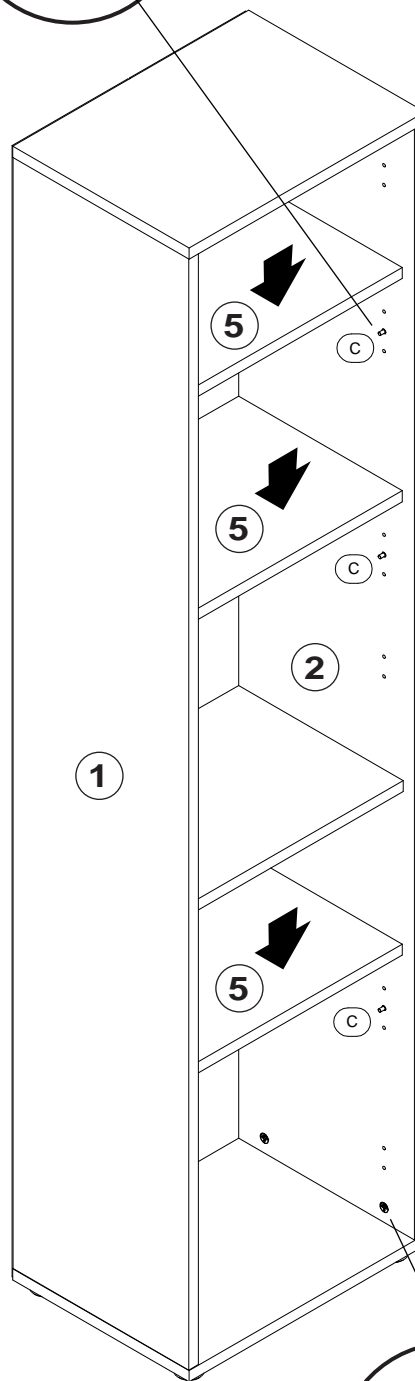
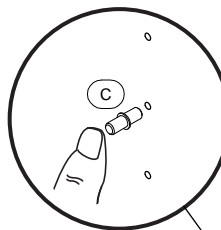

Montageanleitung

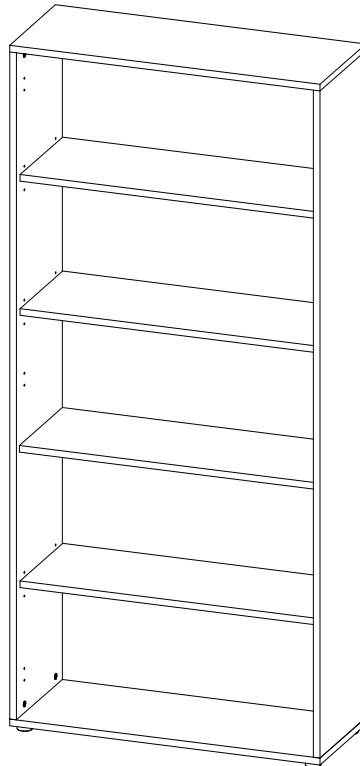

Sehr geehrte Kundin, sehr geehrter Kunde,
wir gratulieren Ihnen zum Erwerb Ihres neuen Möbelstückes.
Trotz größter Sorgfalt kann es aber vorkommen, dass in einem
Beschlagbeutel oder an einem Fertigungsteil ein Mangel ist.
Sollte dies bei Ihrem Möbelstück der Fall sein, kennzeichnen
Sie dieses deutlich auf der Skizze und geben Sie bitte die
fehlende Stückzahl an.

Für evtl. auftretende Rückfragen zum Artikel oder zur Montage
senden Sie uns bitte eine E-Mail:

support@bmg-moebel.de





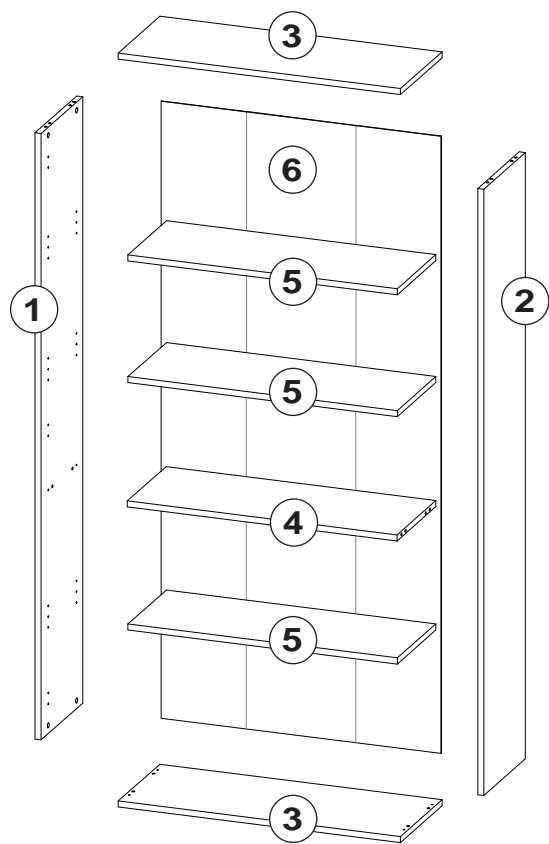
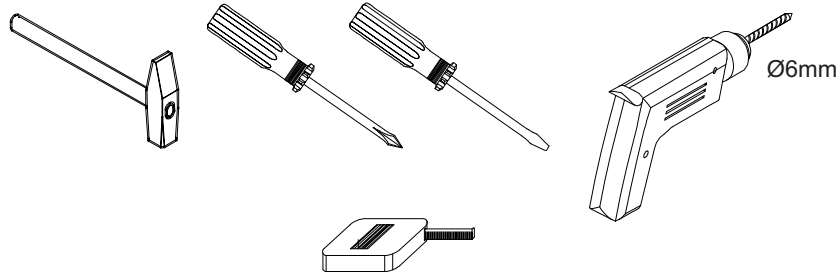
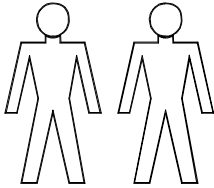

Bitte lesen Sie diese Montageanleitung gut durch, da wir für
Fehler, die durch falsche Montage entstehen keine Haftung
übernehmen!

Office

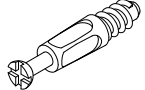
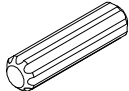
Regal hoch - breit

Für die Montage dieser Type benötigen Sie:

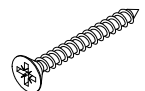

 AA 12 Stück Excenter	 BD 12 Stück Spannbolzen
 DA 12 Stück Holzdübel 30mm	 C 12 Stück Bodenträger
 H 50 Stück Nagel	 FU 4 Stück Gleitfuß
 SB 4 Stück Schraube 4,0x30	 AK 12 Stück Abdeckkappe
 ZA 1 Stück Befestigungssatz	

Name

Straße

PLZ, Ort

Telefon für Rückfragen

E-Mail für Rückfragen

Gekauft bei

Datum

1

AA 12 Stück Excenter	BD 12 Stück Spannbolzen	DA 12 Stück Holzdübel 30mm

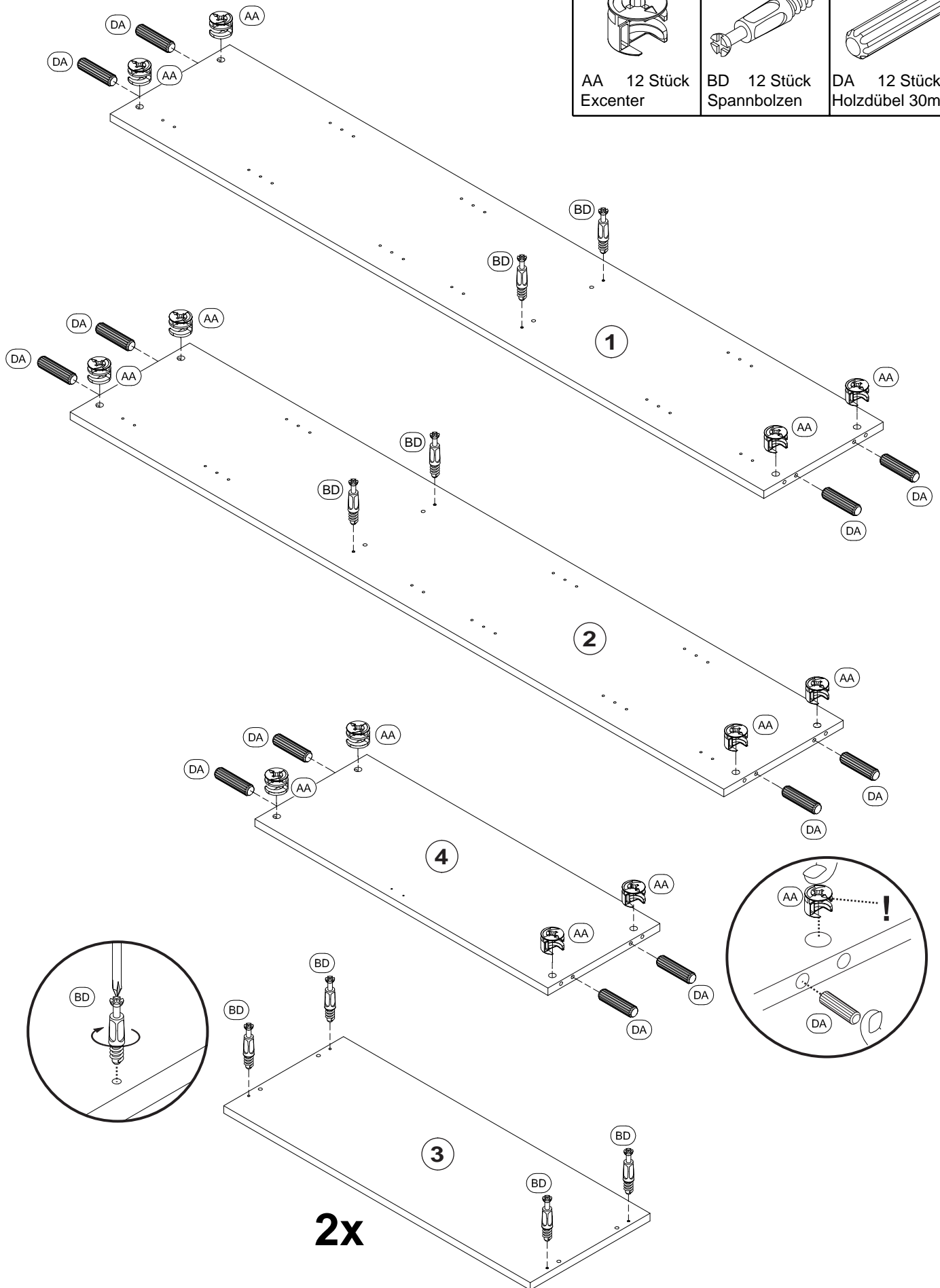

2

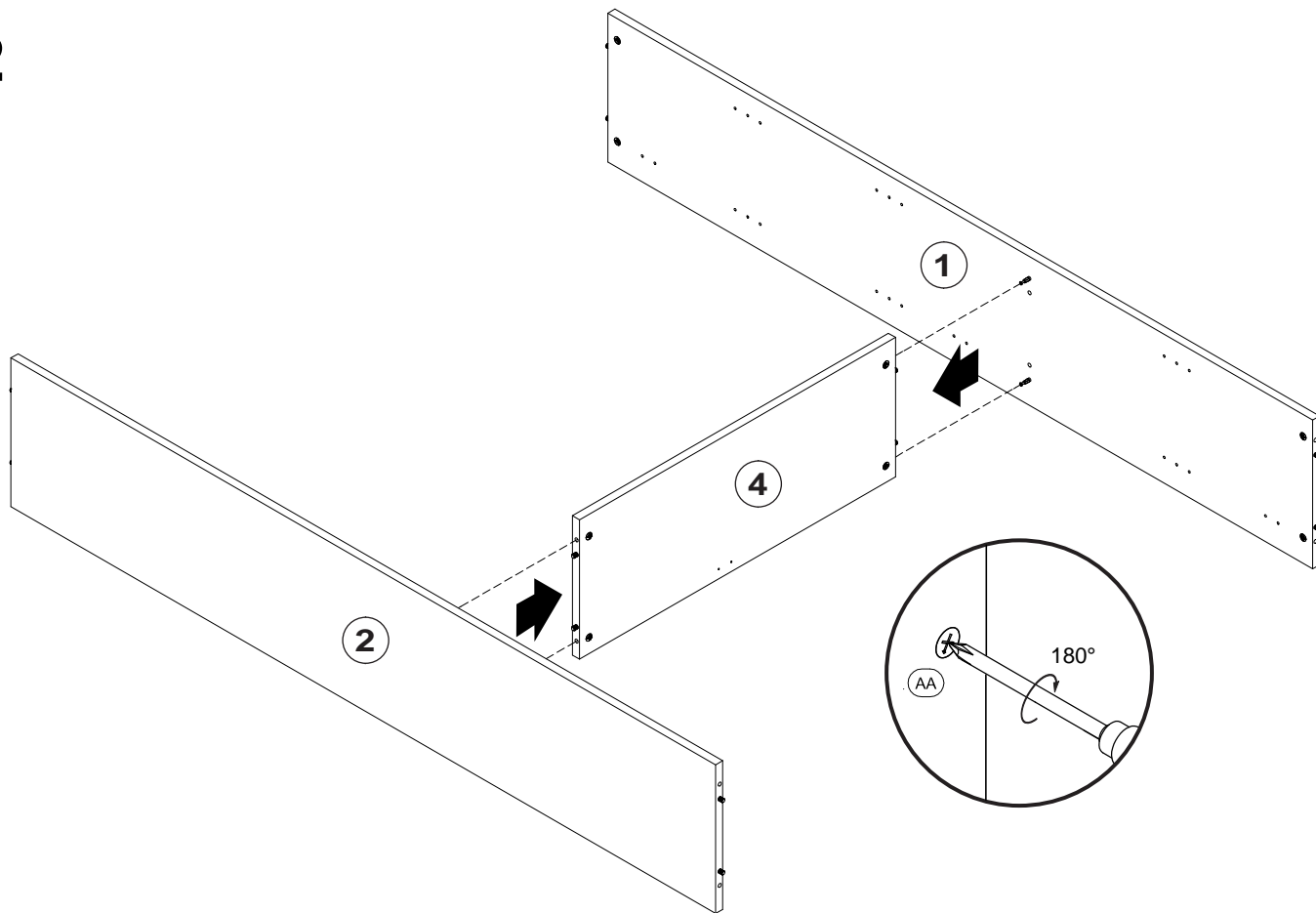

3

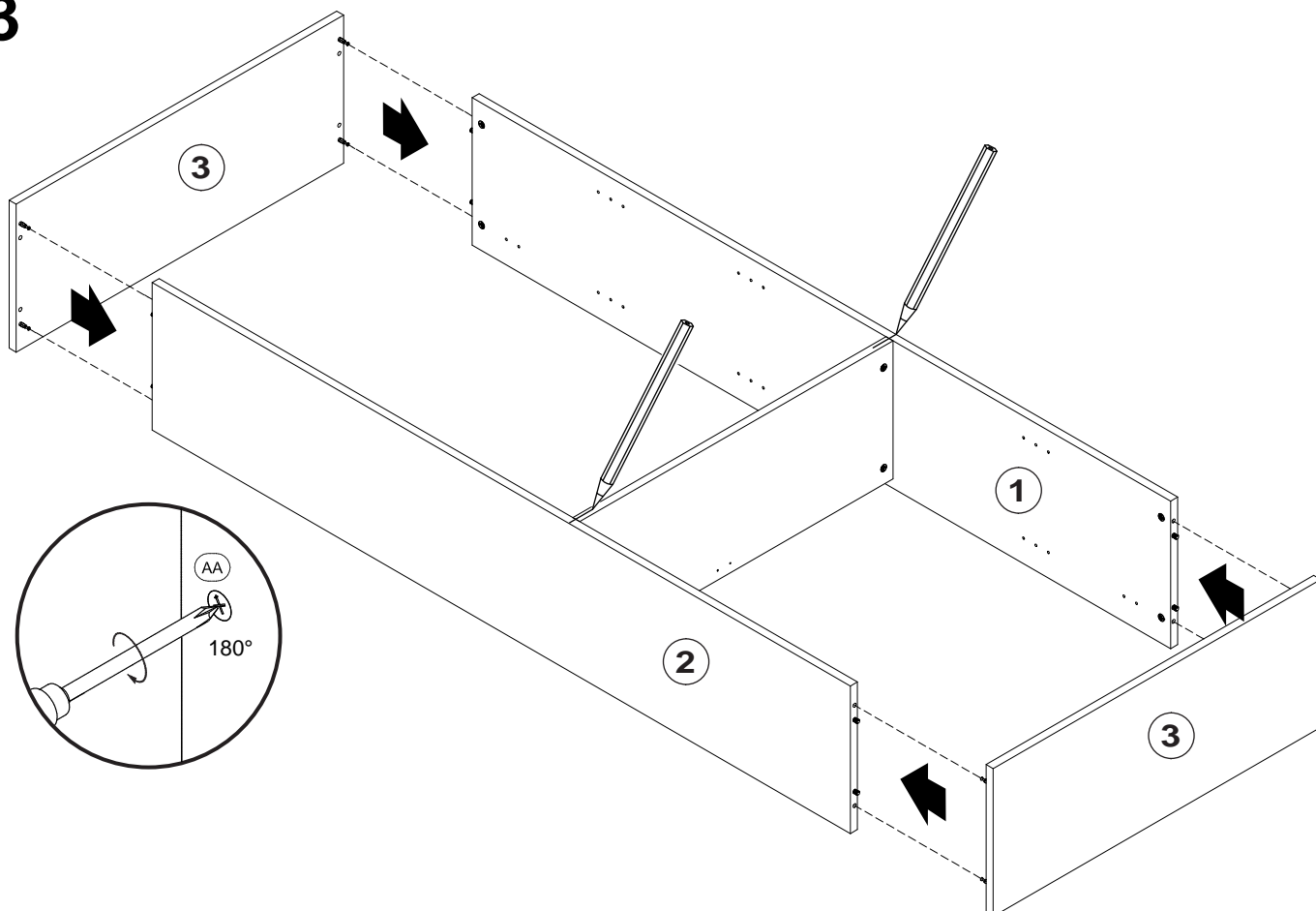

4

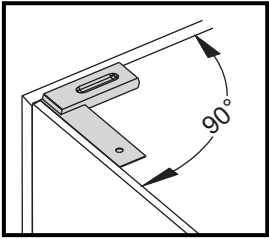

H 50 Stück Nagel	FU 4 Stück Gleitfuss	SB 4 Stück Schraube 4,0x30

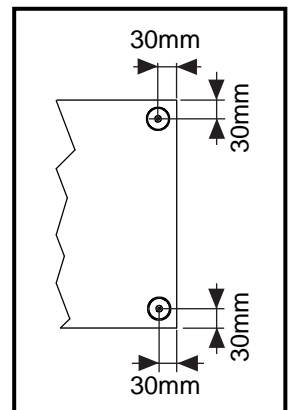
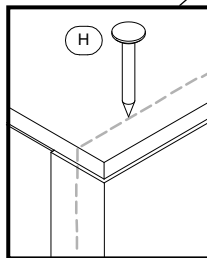
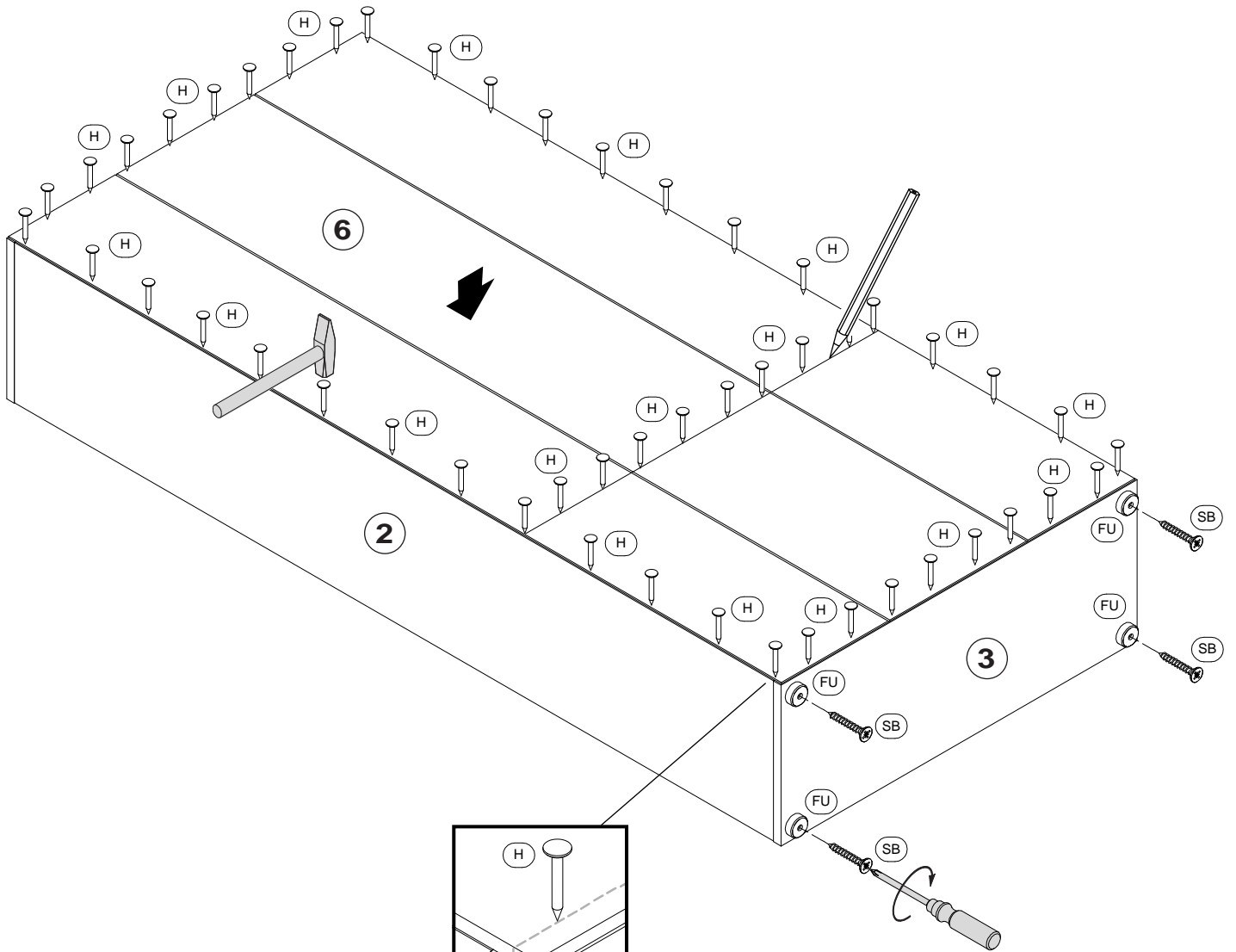

Office

Regal hoch - breit

5



Achtung!
Wandbefestigung
zwingend erforderlich.

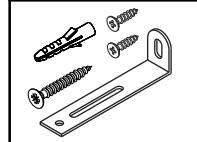

ZA 1 Stück
Befestigungssatz

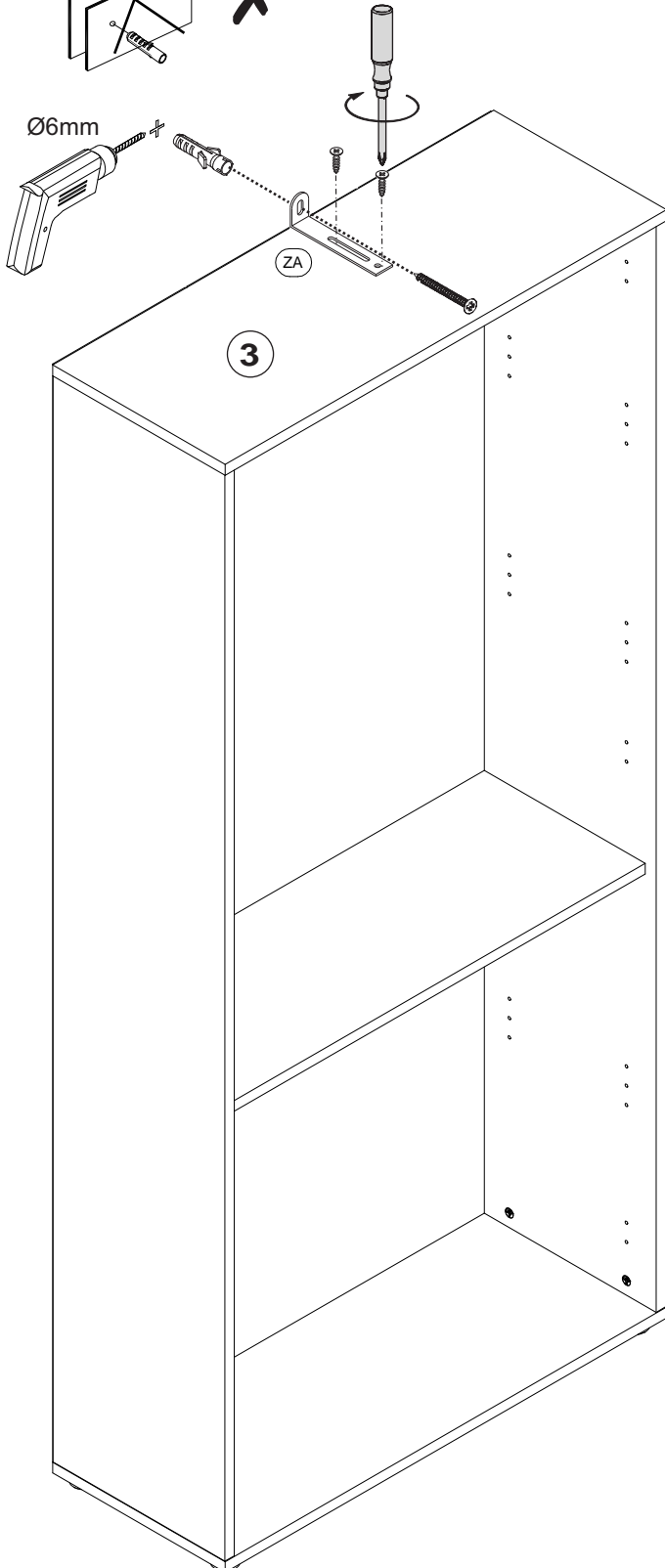
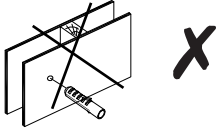
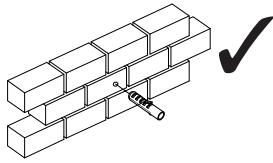

6

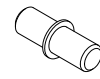

C 12 Stück
Bodenträger

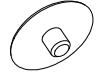

AK 12 Stück
Abdeckkappe

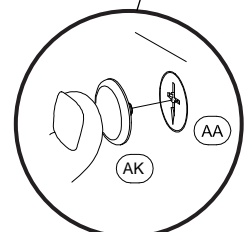
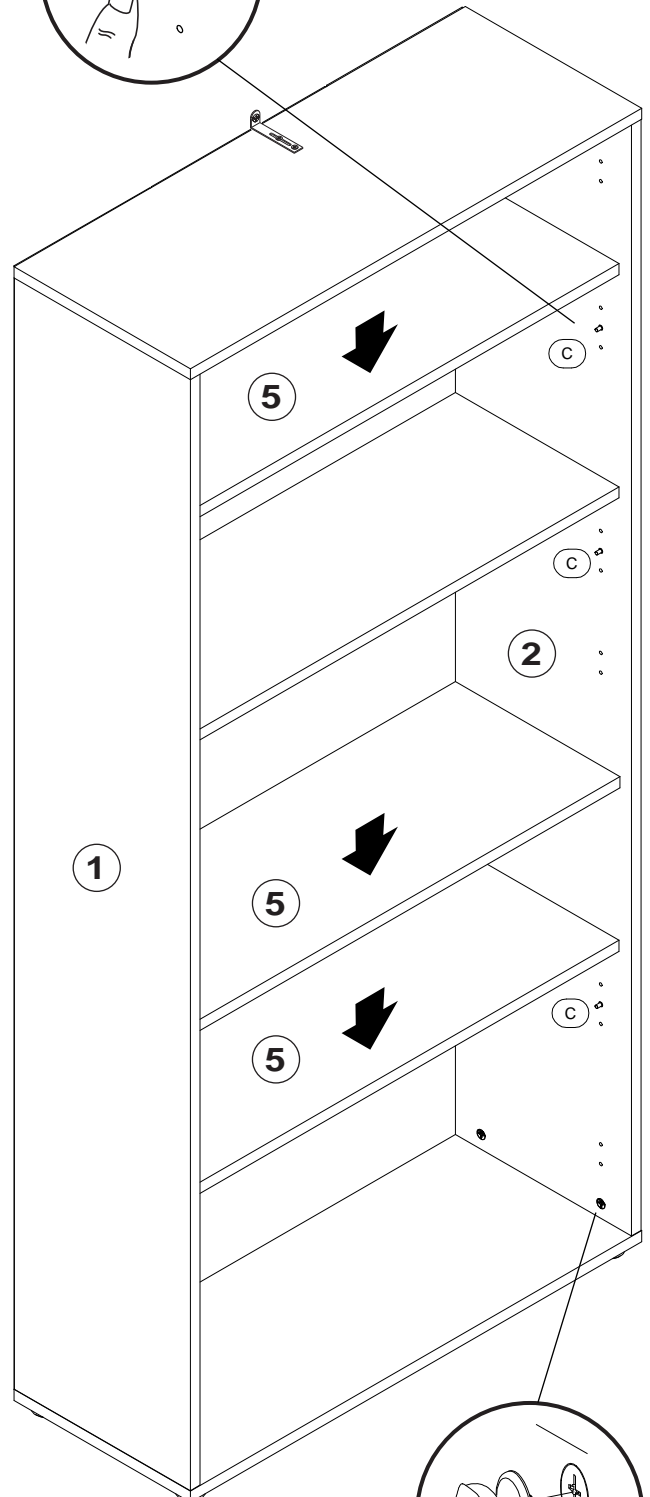
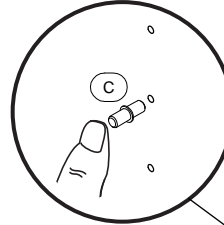

Montageanleitung

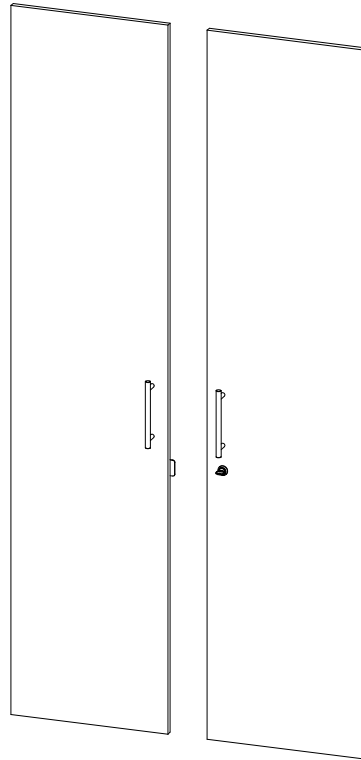

Sehr geehrte Kundin, sehr geehrter Kunde,
wir gratulieren Ihnen zum Erwerb Ihres neuen Möbelstückes.
Trotz größter Sorgfalt kann es aber vorkommen, dass in einem
Beschlagbeutel oder an einem Fertigungsteil ein Mangel ist.
Sollte dies bei Ihrem Möbelstück der Fall sein, kennzeichnen
Sie dieses deutlich auf der Skizze und geben Sie bitte die
fehlende Stückzahl an.

Für evtl. auftretende Rückfragen zum Artikel oder zur Montage
senden Sie uns bitte eine E-Mail:

support@bmg-moebel.de

Bitte lesen Sie diese Montageanleitung gut durch, da wir für
Fehler, die durch falsche Montage entstehen keine Haftung
übernehmen!

Office

Türen hoch

Für die Montage dieser Type benötigen Sie:

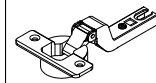
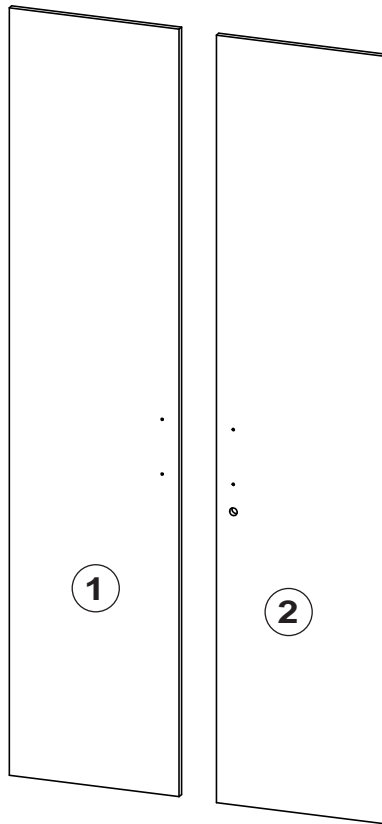
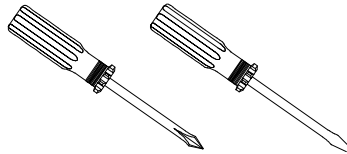
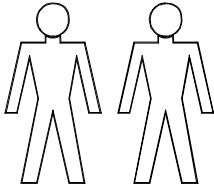

TF 6 Stück
Scharnier

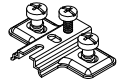

TD 6 Stück
Montageplatte



SA 16 Stück
Schraube 3,5x15

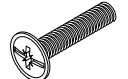

VR 4 Stück
Schraube 4,0x22

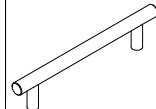

GF 2 Stück
Griff



ZS 1 Stück
Zylinderschloss

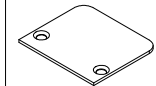

AG 1 Stück
Anschlag

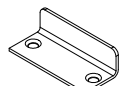

AW 1 Stück
Anschlagwinkel

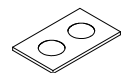

PU 1x2 Stück
Puffer

Name

.....

Straße

.....

PLZ, Ort

.....

Telefon für Rückfragen

.....

E-Mail für Rückfragen

.....

Gekauft bei

.....

Datum

.....

Office

Türen hoch

1

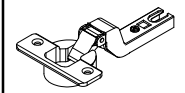
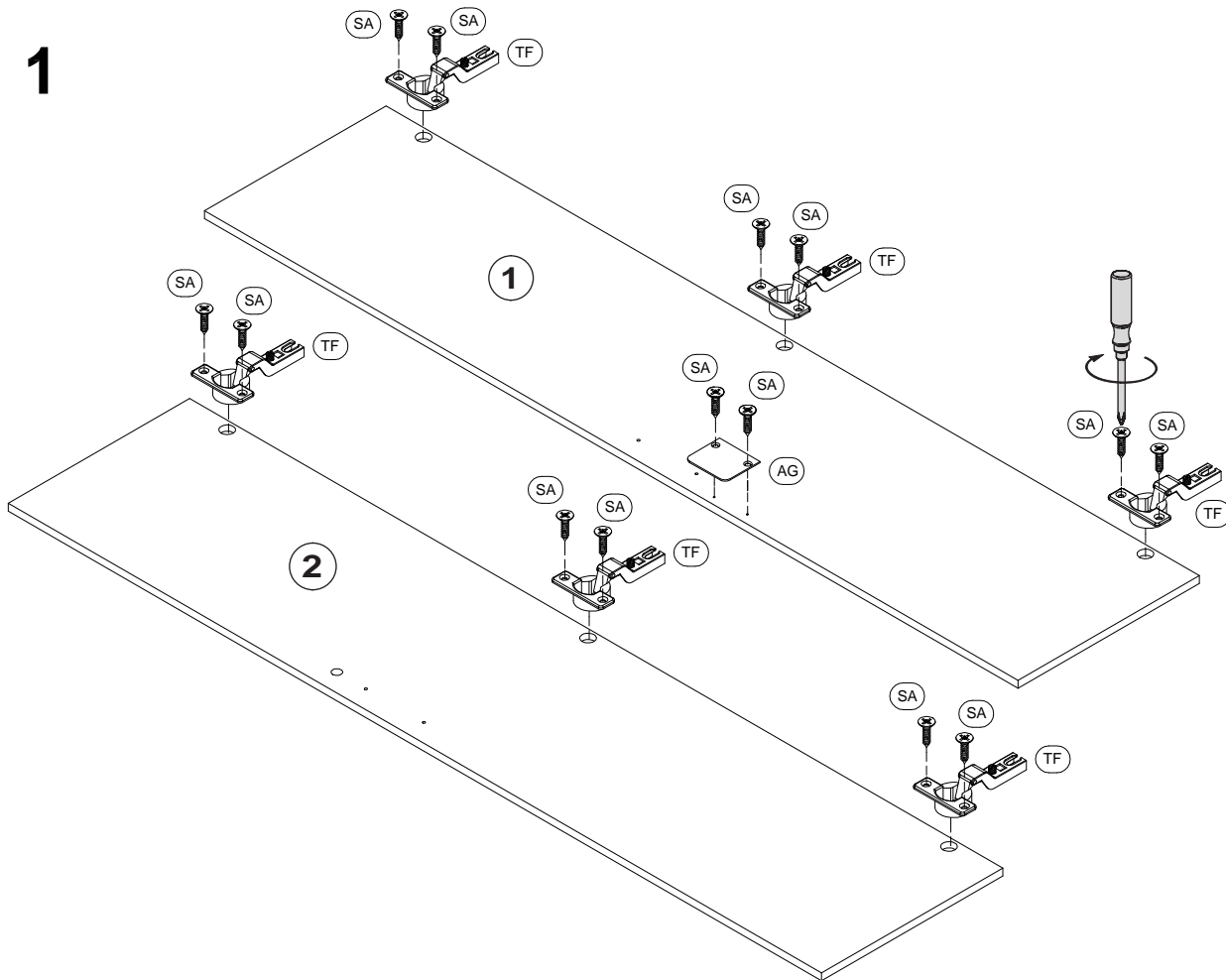

TF 6 Stück
Scharnier

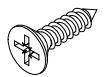

SA 14 Stück
Schraube 3,5x15

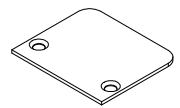

AG 1 Stück
Anschlag

2

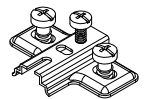
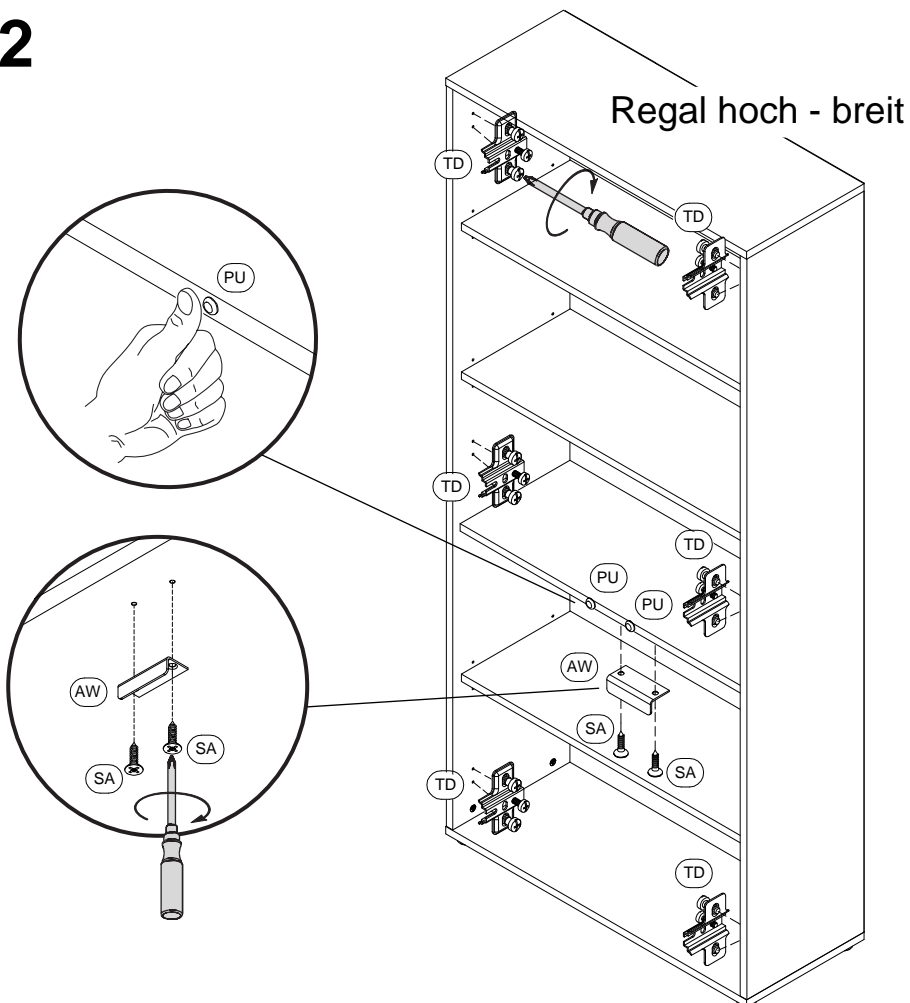

TD 6 Stück
Montageplatte

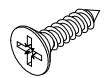

SA 2 Stück
Schraube 3,5x15

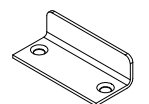

AW 1 Stück
Anschlagwinkel

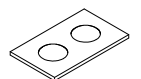

PU 1x2 Stück
Puffer

3

