

980100

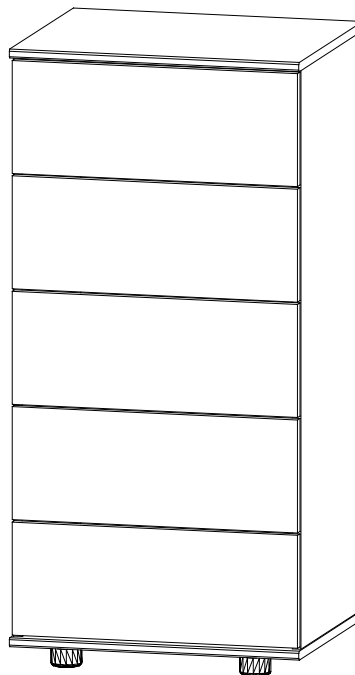

700

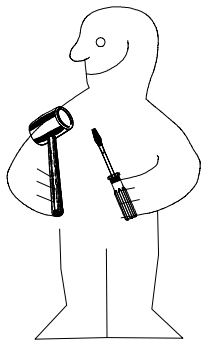

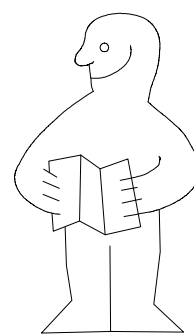
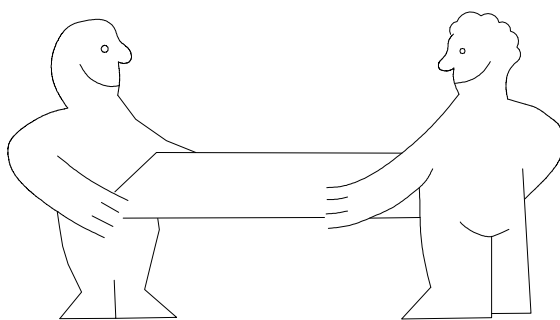
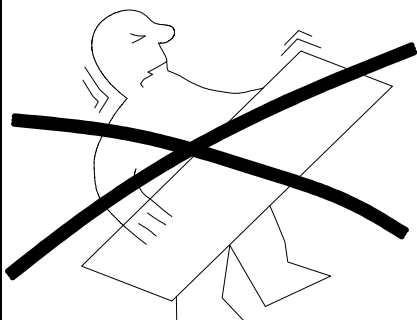

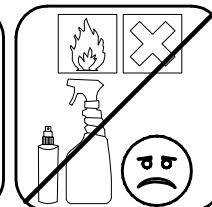
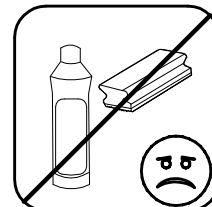
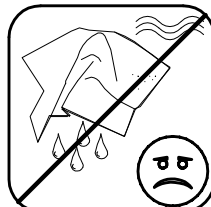
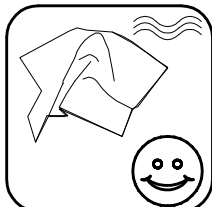
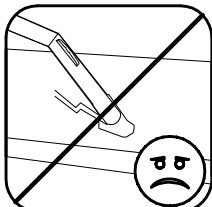
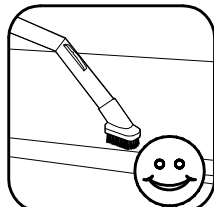
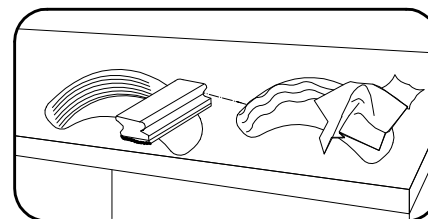
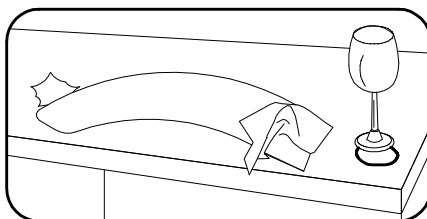
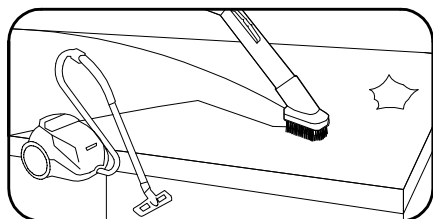
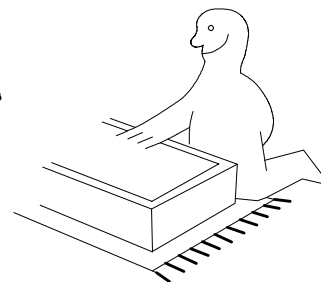
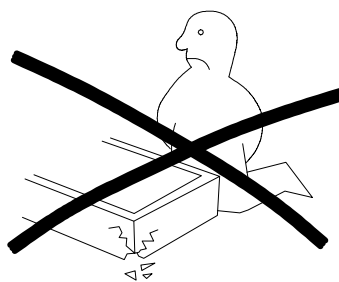
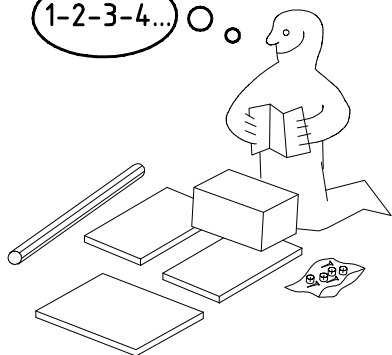

1-2-3-4... ○ ○



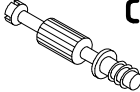

980100

17.03.14 / 24.04.24 04 24 1/7

	A	8x
	D	8x
	C	8x

	Z	2x
	SBV	4x

	Y20	10x
	G8	10x
	T3	20x

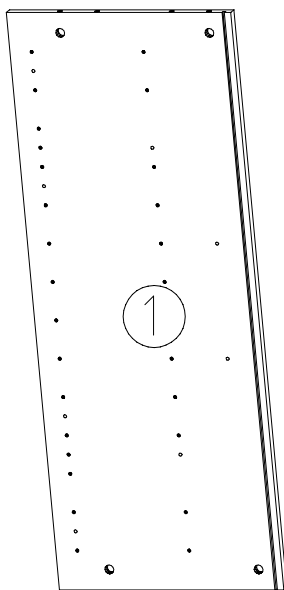
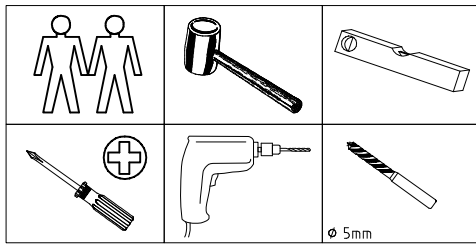
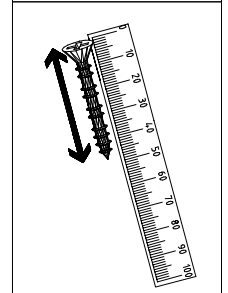
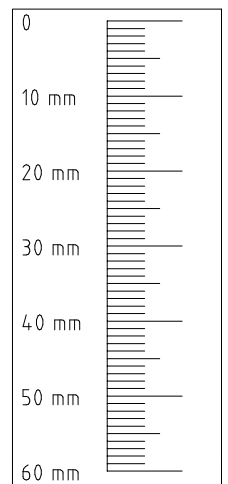
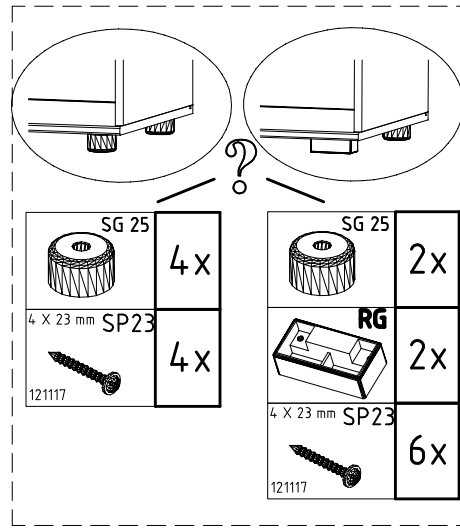

962x385x15

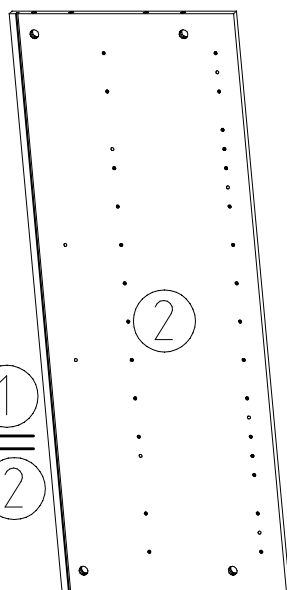

962x385x15

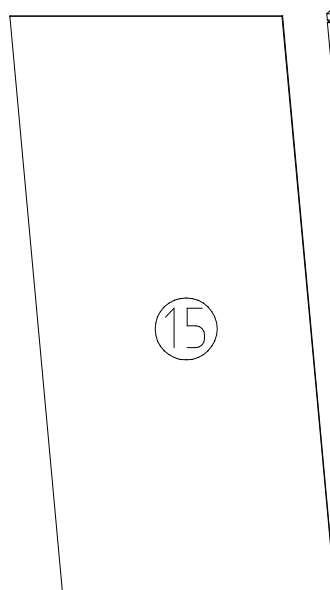

971x467x2,5

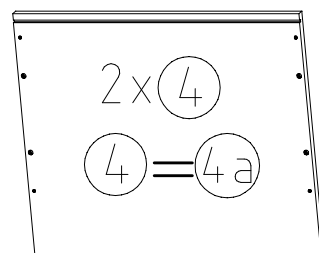

491x405x15

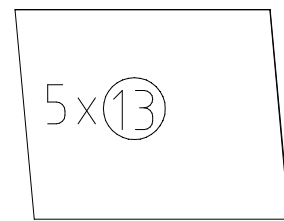

437x349x2,5

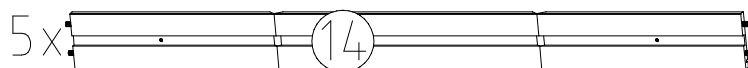

350/451/350x92x12,4

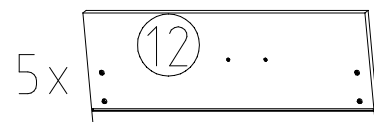

484x188x15

1

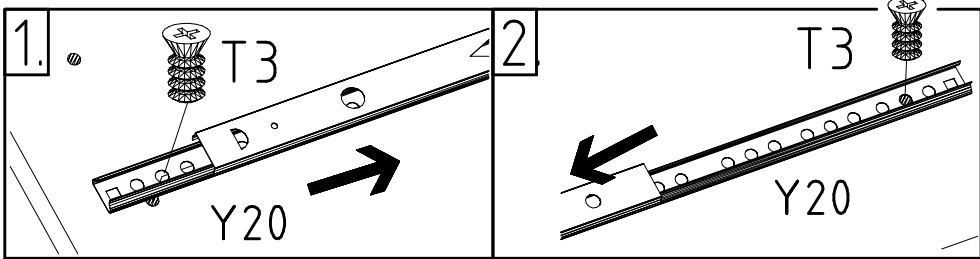
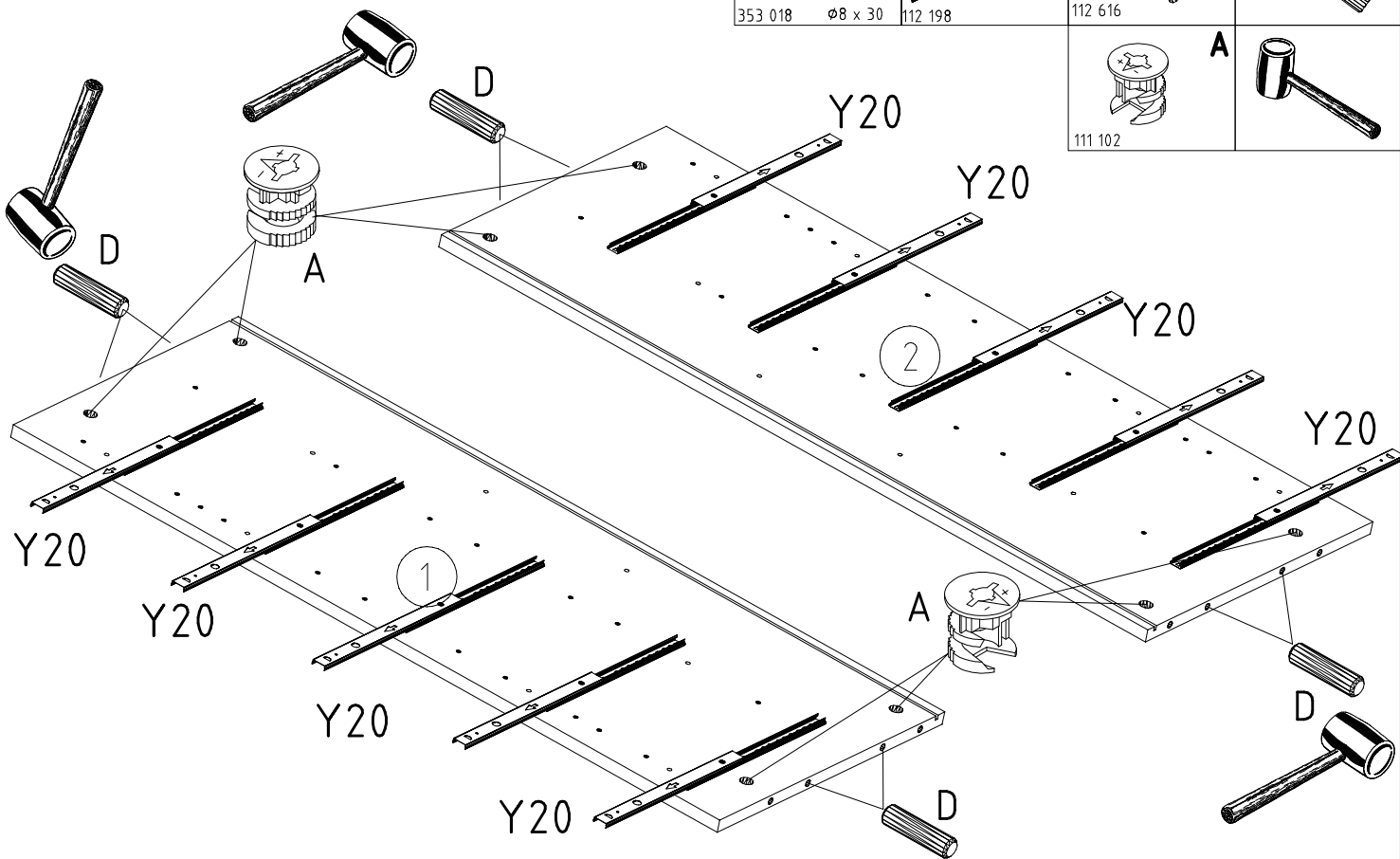
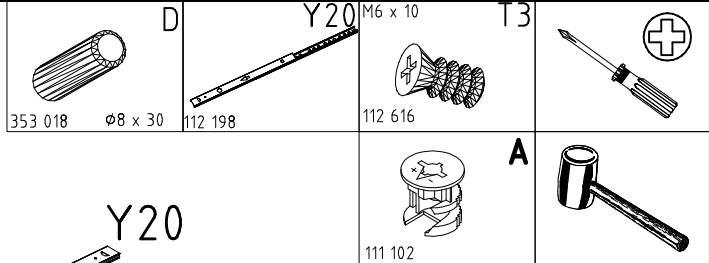

2

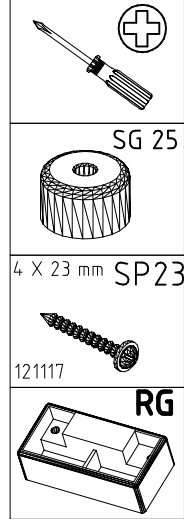
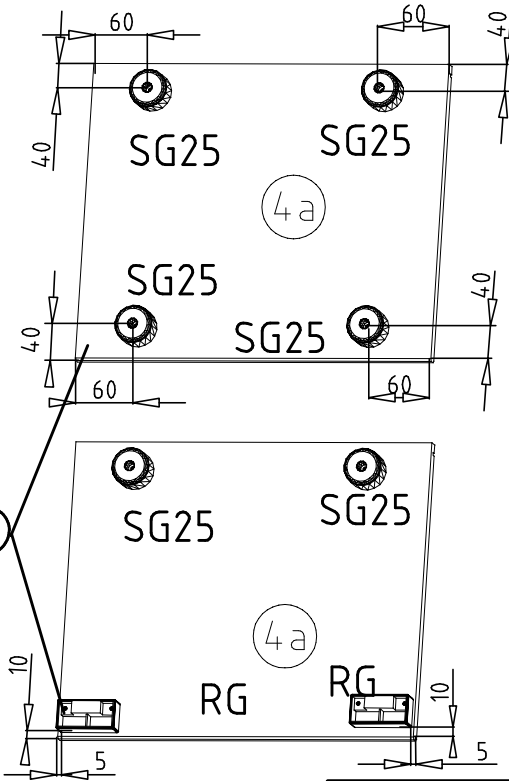
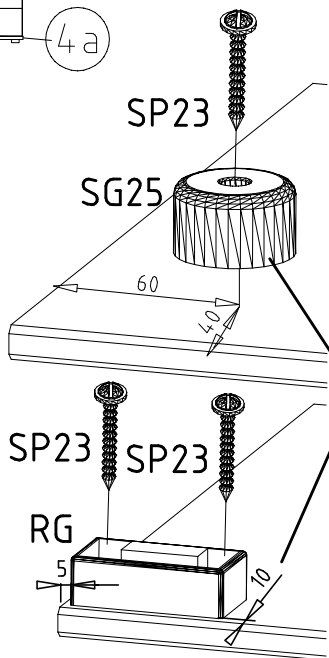
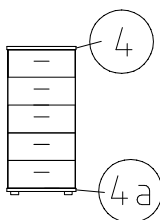

3

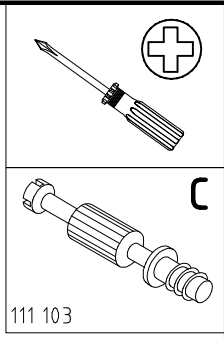
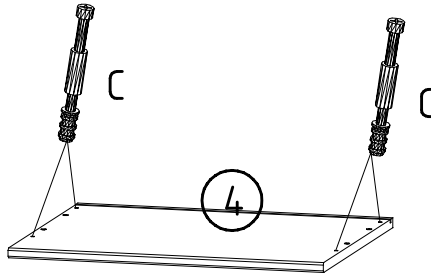
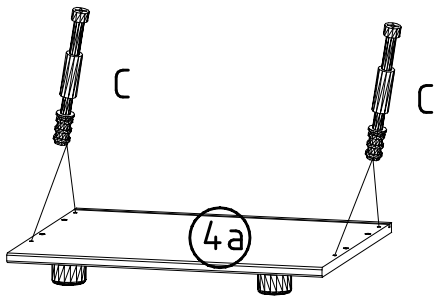

4

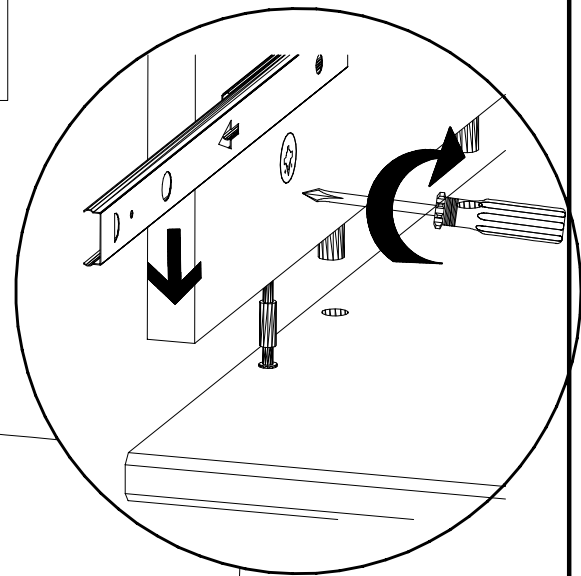
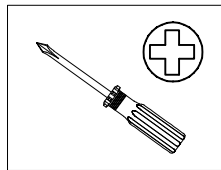
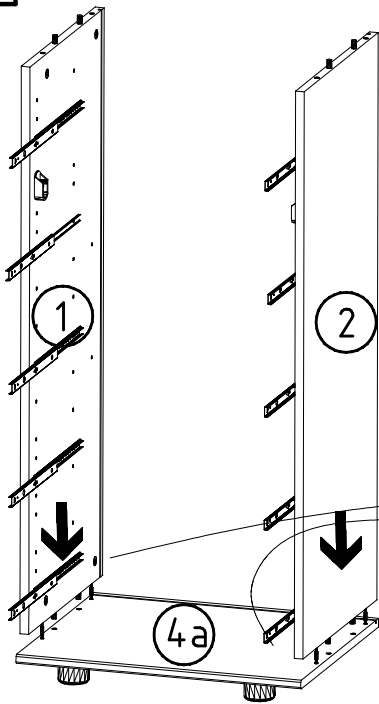

5

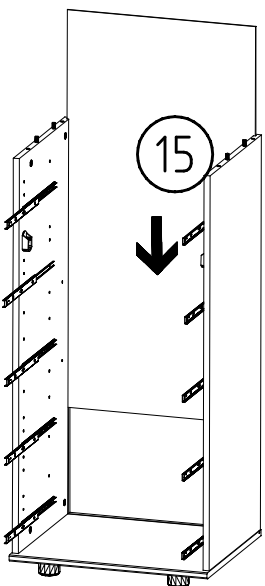

6

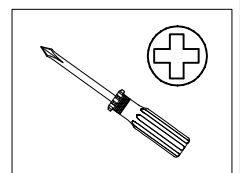
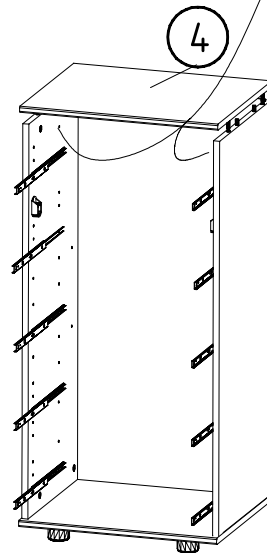

7

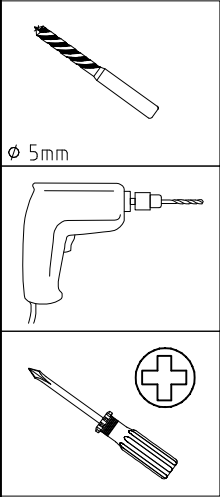

∅ 5mm

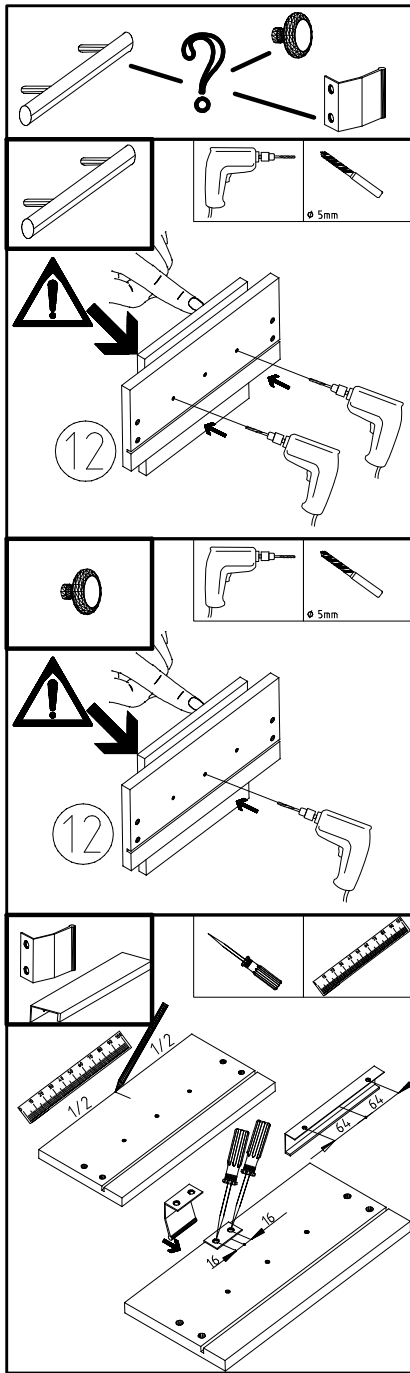

8

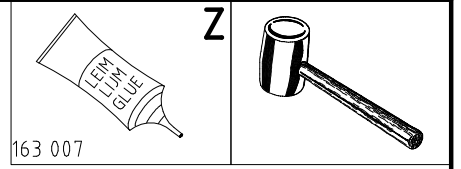

163 007

Z

A

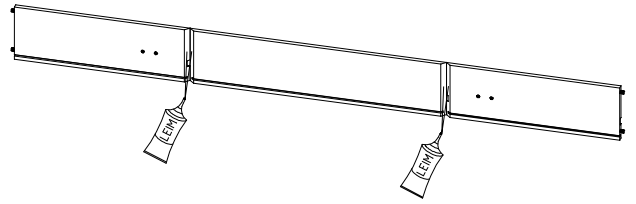

B

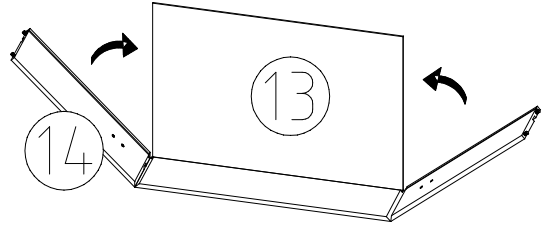

C

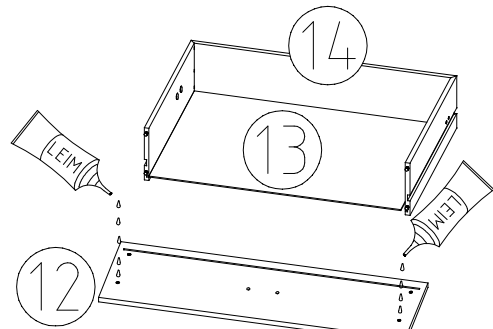

D

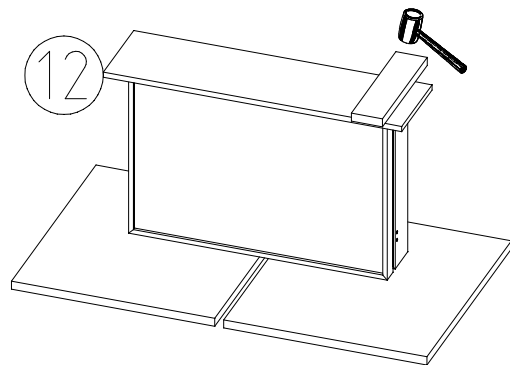

9

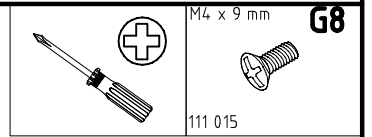
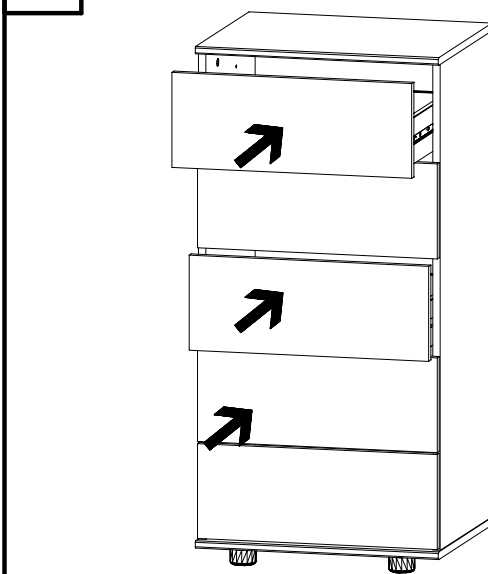

M4 x 9 mm

G8

111 015

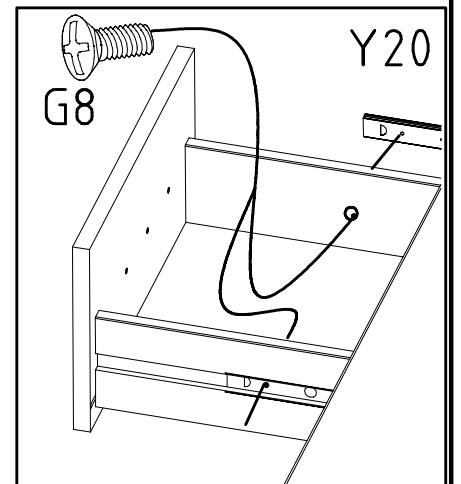

Y20

G8

980100

17.03.14 / 24.04.24 04 24 5/7

10

SBV

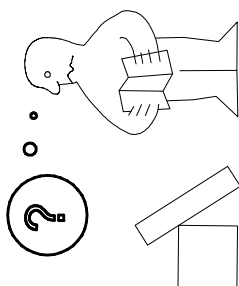
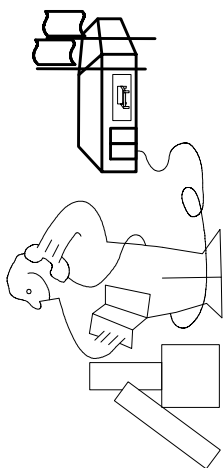
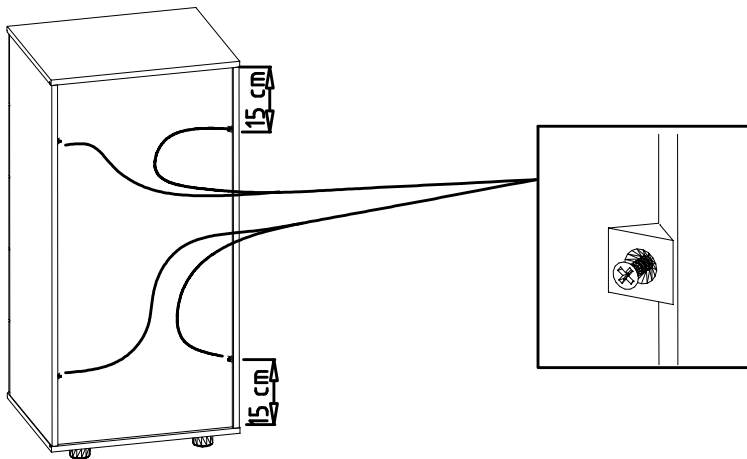
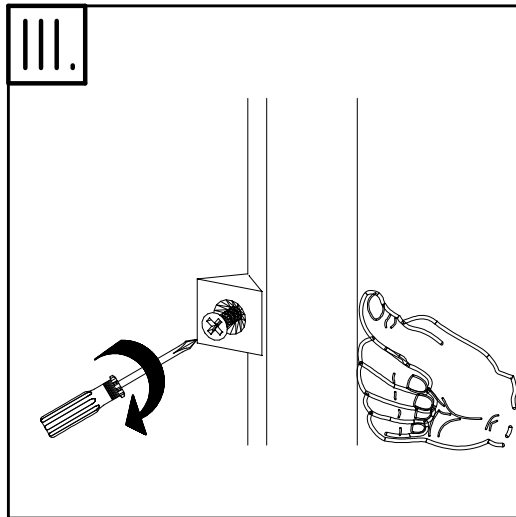
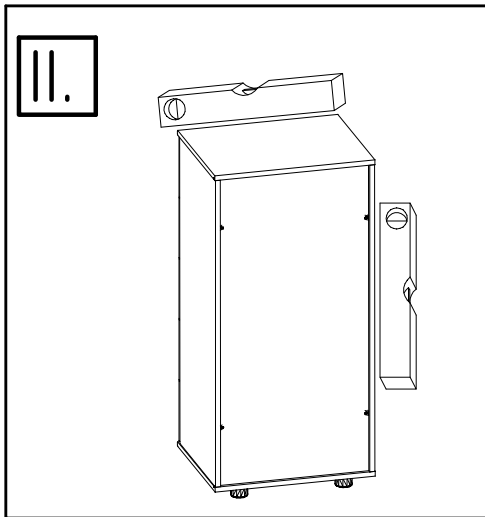
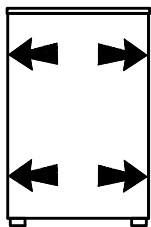
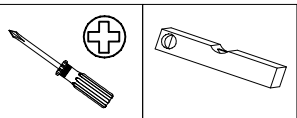
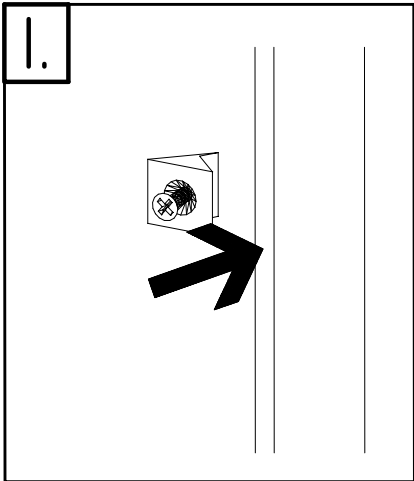
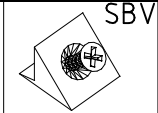

Modell/Model/Modèle

--	--	--	--	--	--

5

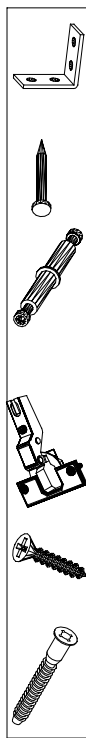

<121 370>	< G 1 >	<4x>

Anderungen die dem technischen Fortschritt geschuldet sind, behalten wir uns vor!
 Bei nicht vorschriftsmäßiger und/ oder nicht fachmännischer Montage wird bei Personen-
 und/ oder Sachschäden keinerlei Haftung übernommen.

TOUF-NR. / TOUF-NO.	BOX-NR. / BOX-NO.	AUFLAG / UZDF-NO. / NO. DE L'ARTICLAGE
23203	30110XY	
Kunde / Customer / Client MAX MUSTERMANN		
Kommission / your order reference / votre reference 3377 MINDEN		
Dekor / Decor / Décor / Modell / Model / Modèle F99 SAMPLE		
F99842 SCHWEBTÜRENSCHRANK 250 CM H 216CM PLANKENEICHE NB + RAU STEEL PLANKENEICHE NACHBILDUNG		
Barcode: 202320301107241476000001		
Paket / Package / Paquet 414760 SOCKEL		
Paket / von	8	colli Kommission 10
HSP-SWIT BOD 50 TEXT/TEX SOCKEL 32 FRESH TV / LIT SO-BOD TEXT RASTEX/ ZNBOD D18MM 1X KLSTA 104		
Montage - Anleitung	KS-64	Laenge 520,0 Breite 568,0
SOCKEL32 KLEB		



104
 OBEN
 5
 30/19
 HAUT
 23.08.19
 SOFFEN / 1.
 ABOVE
 OBEN

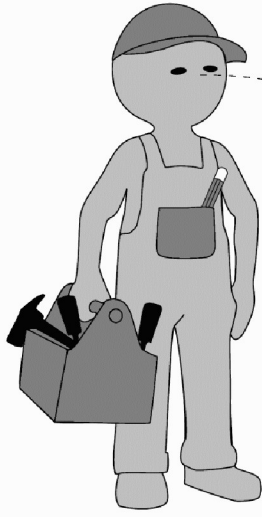

WIMEX Wohnbedarf
 Import Export Handelsges mbH & Co. KG
 Werner-von-Siemens-Str. 35
 D-49124 Georgsmarienhütte - Germany

SAMPLE **23.08.19**
 Modellname Produktionsdatum
 Model Date of manufacture

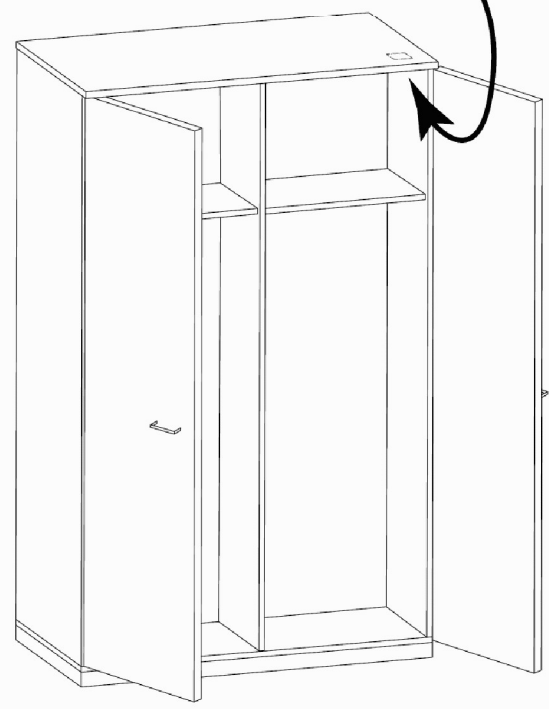
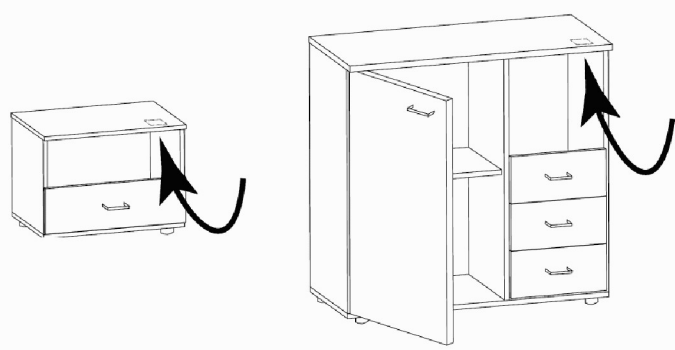
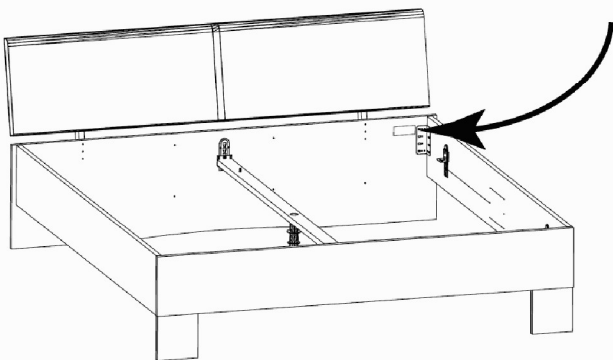

980134

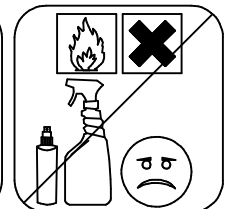
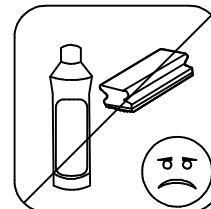
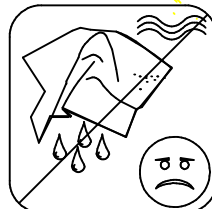
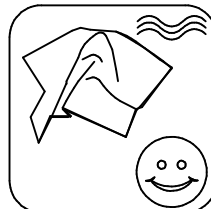
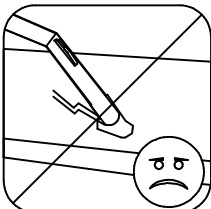
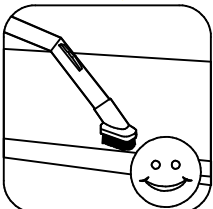
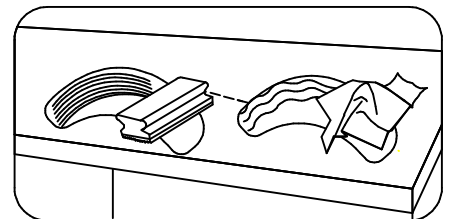
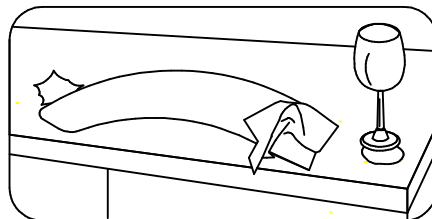
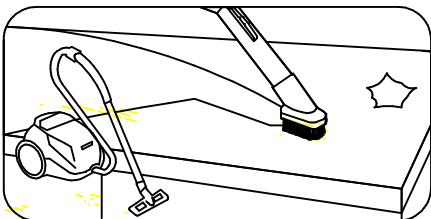
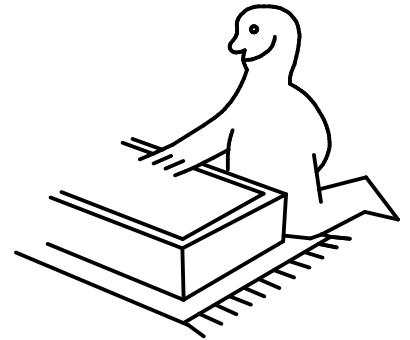
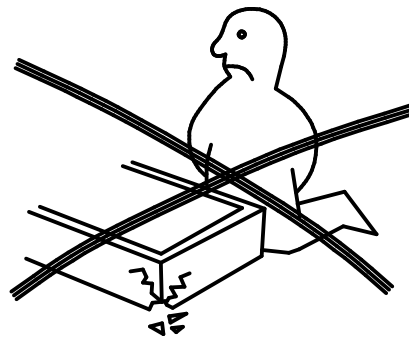
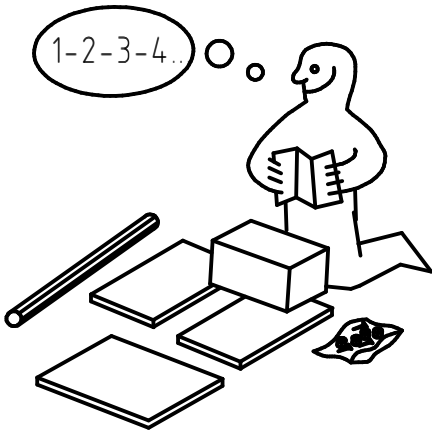
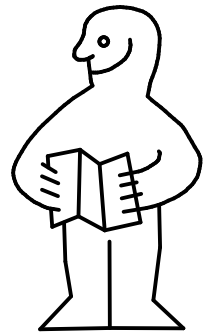
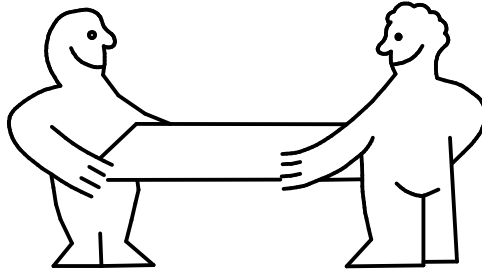
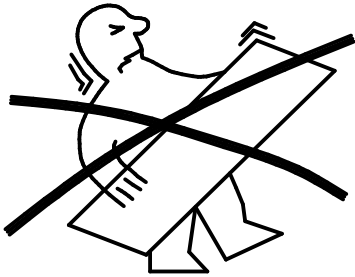
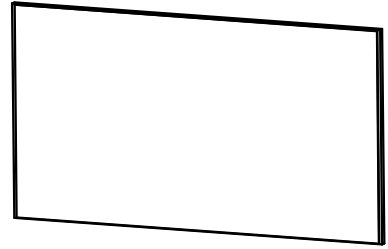
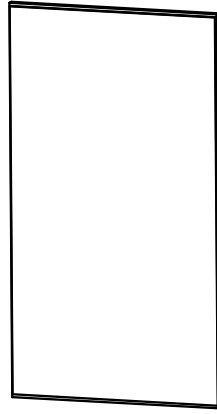
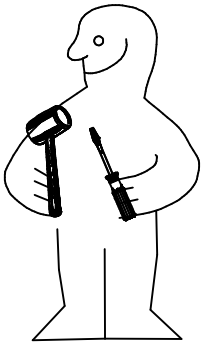

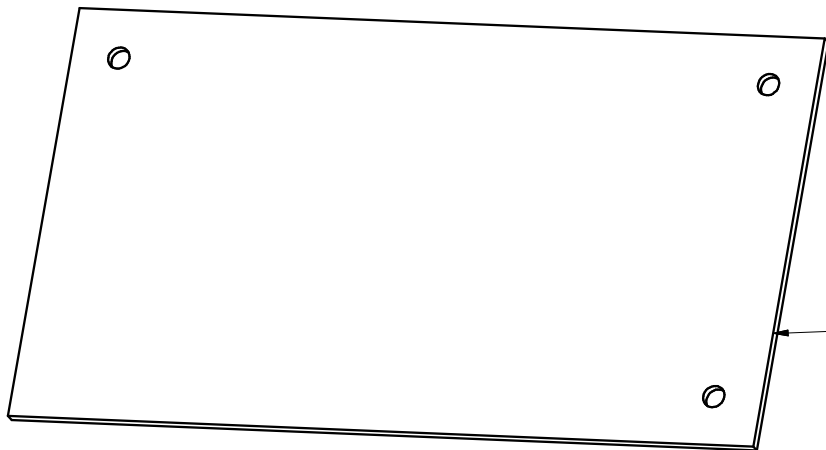

1
1060x578x15

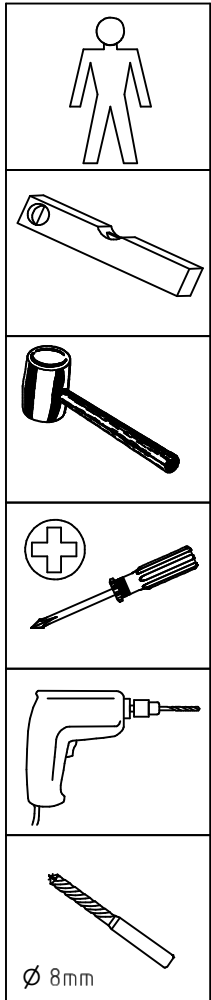

	2 X H3
	4 X G1
	2 X SH

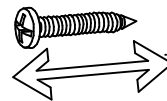
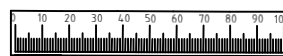
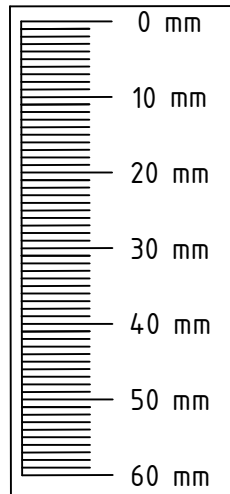

1

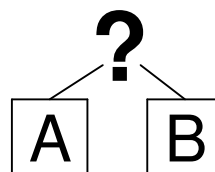
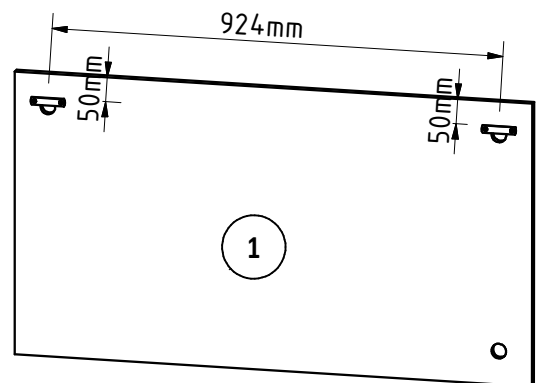
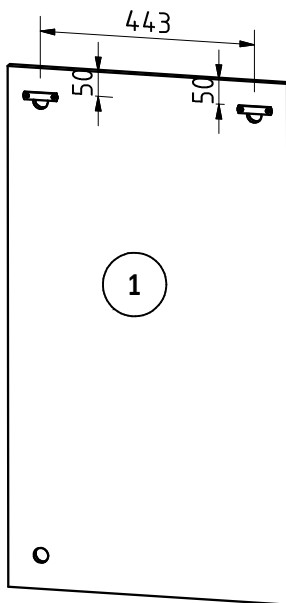
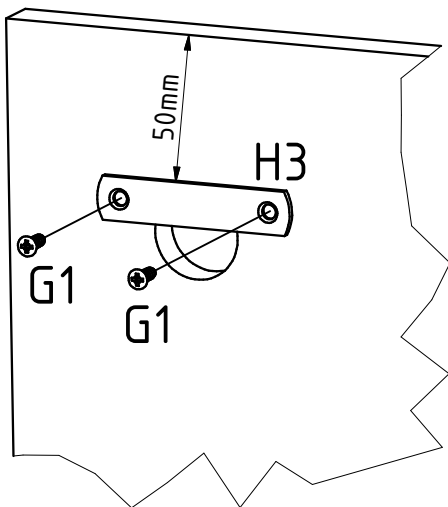

2

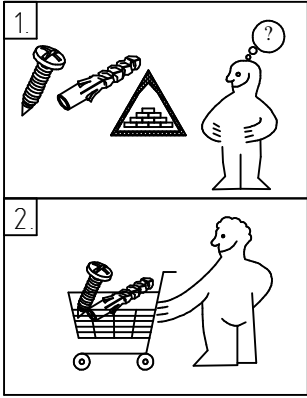

A B

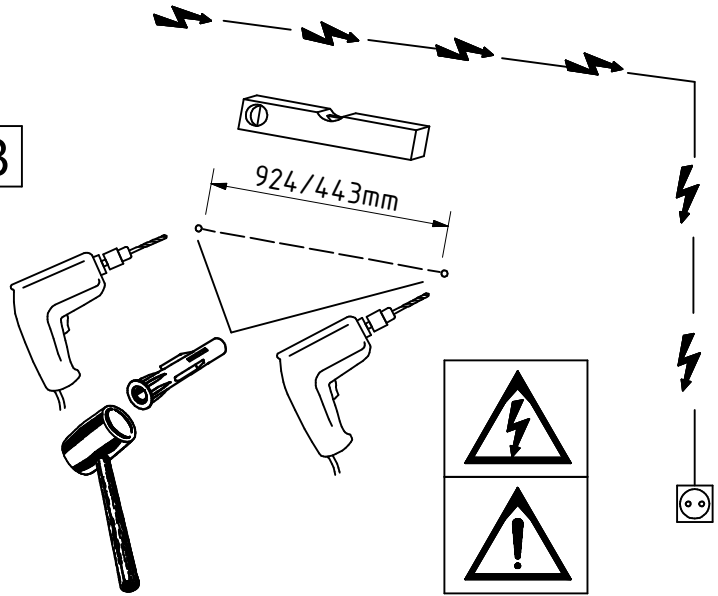

3

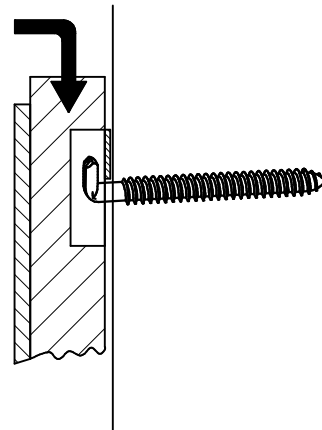
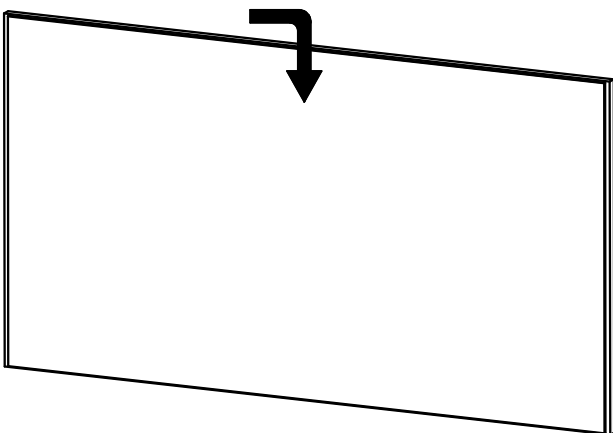
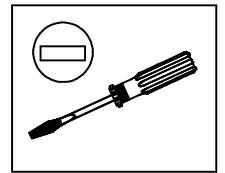
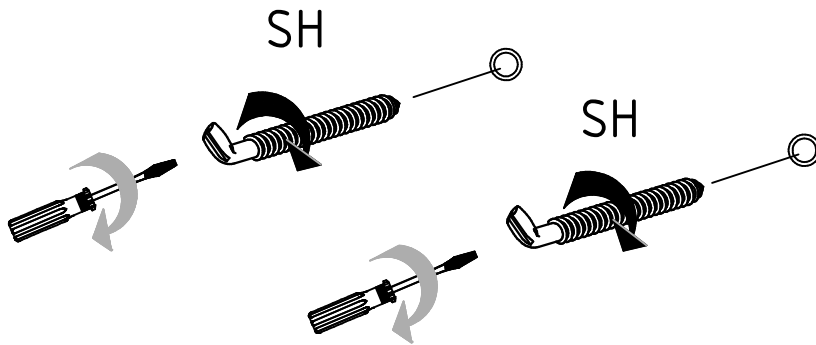

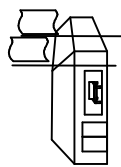
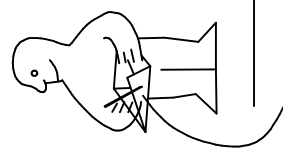
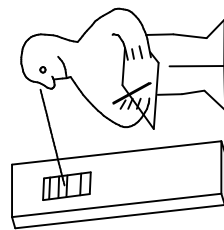
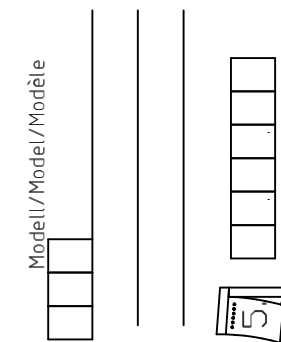
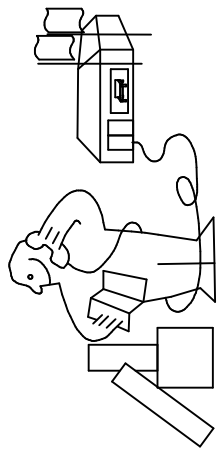
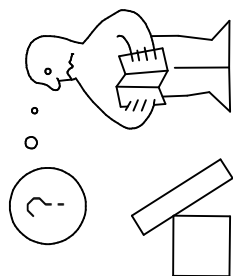

(121 370)	(G 1)	(4x)

Anderungen die dem technischen Fortschritt geschuldet sind, behalten wir uns vor !
 Bei nicht vorschriftsmäßiger und/ oder nicht fachmännischer Montage wird bei Personen- und/ oder Sachschäden keinerlei Haftung übernommen.
 WIMEX Wohnbedarf/ Import Export Handels GmbH/ Postfach 14.07/ 49112 Georgsmarienhütte/ Germany
 Tel.:(+49) 054.01 8598 72 Fax: (+49) 054.01 8598 33 Mail: service_H@wimex-online.com

980210

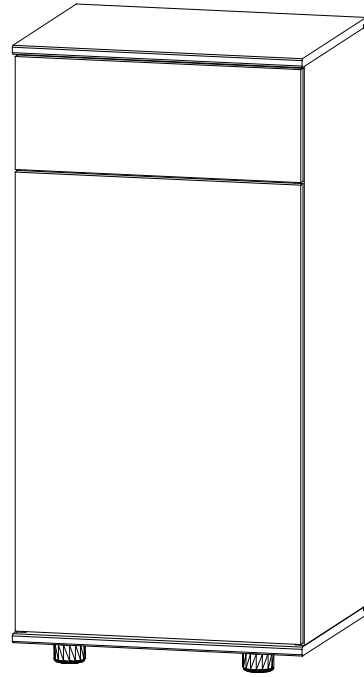
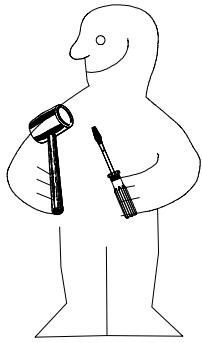

712

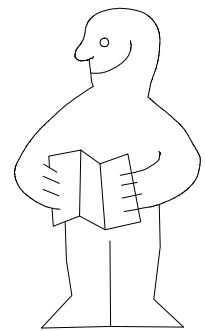
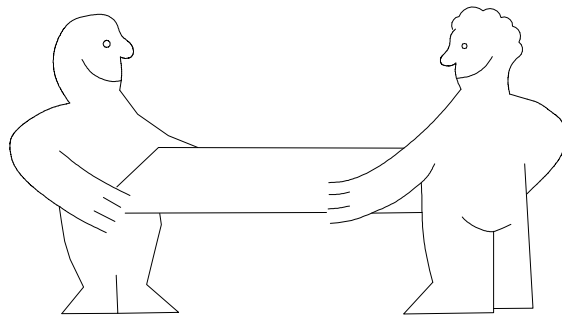
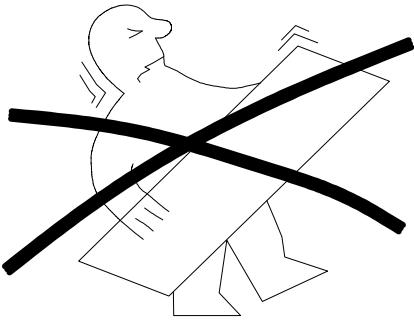

1-2-3-4... ○ ○

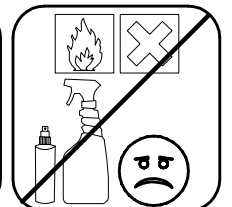
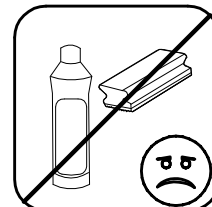
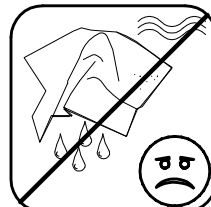
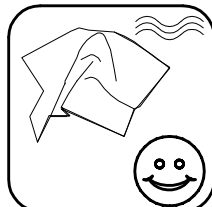
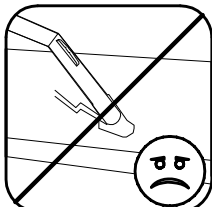
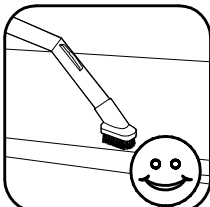
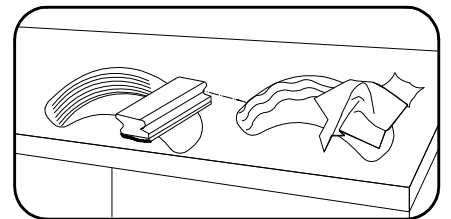
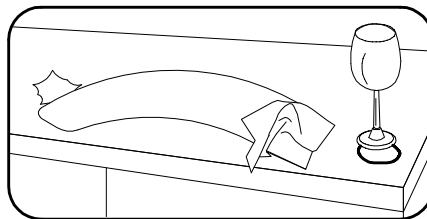
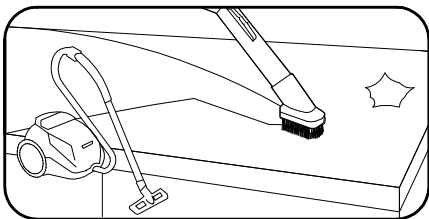
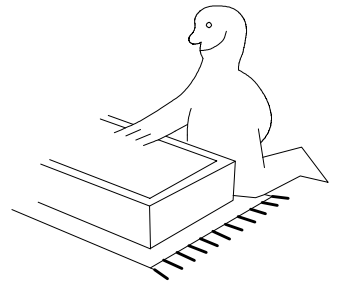
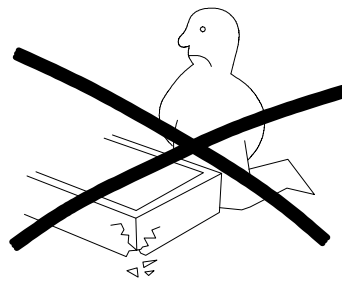
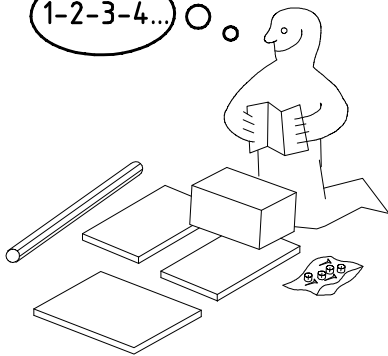









980210



19.08.15 / 03.05.24

05 24

1/9

	A	8x
	D	8x
	C	8x
	L7	4x

	Z	2x
	SBV	4x
	M27	2x
	N27	2x

	Y20	2x
	G8	2x
	T3	4x

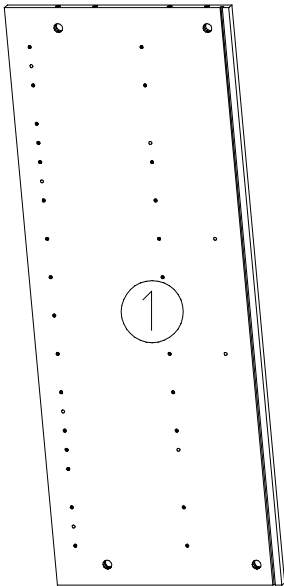
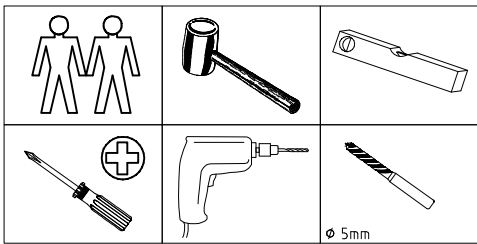
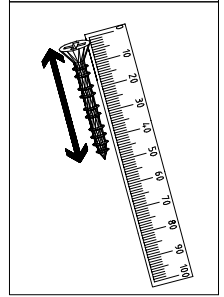
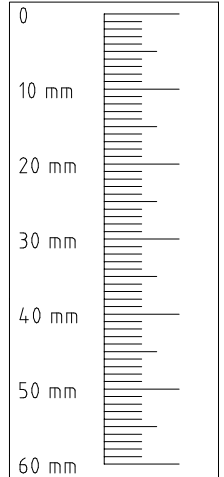
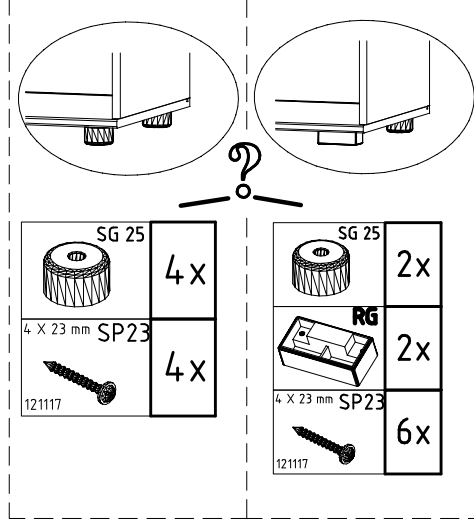

962x385x15

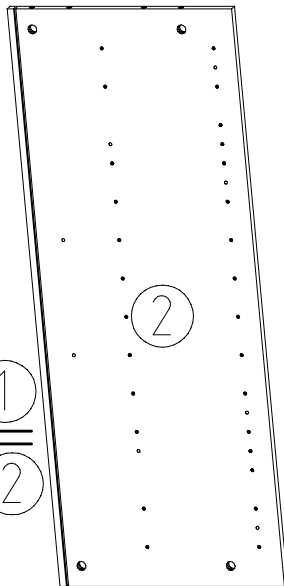

962x385x15

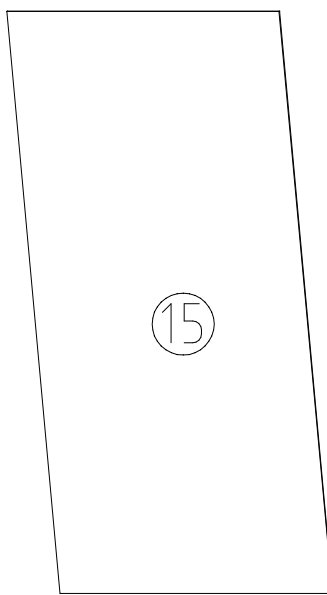

971x467x2,5

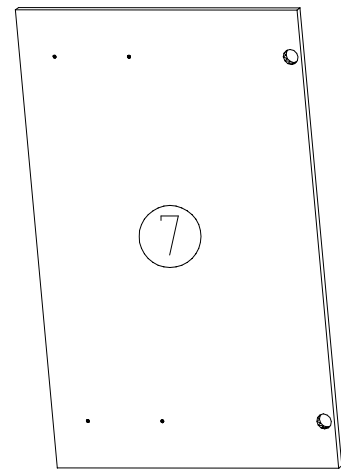

730x484x15

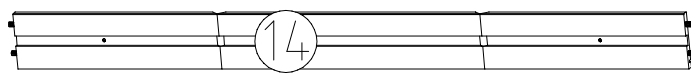

350/451/350x92x12,4

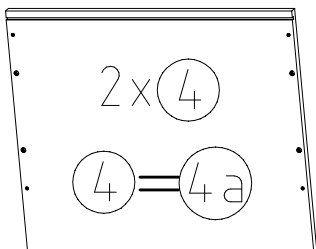

491x405x15

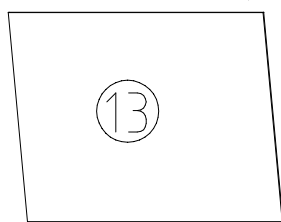

437x349x2,5

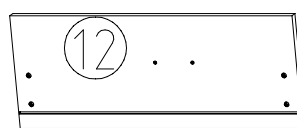

484x188x15

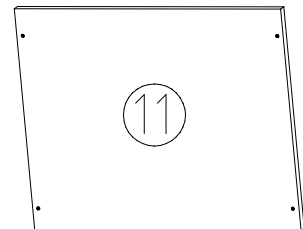

458x370x15

1

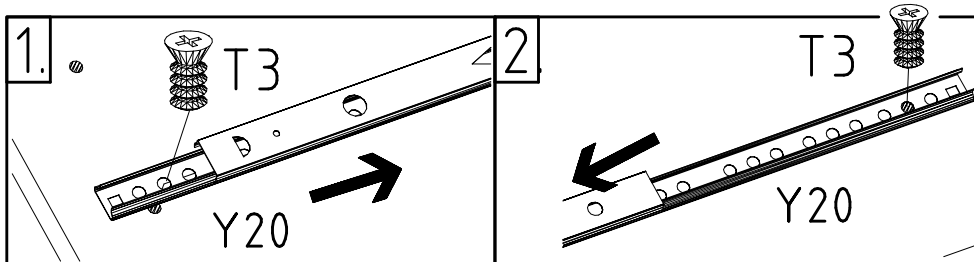
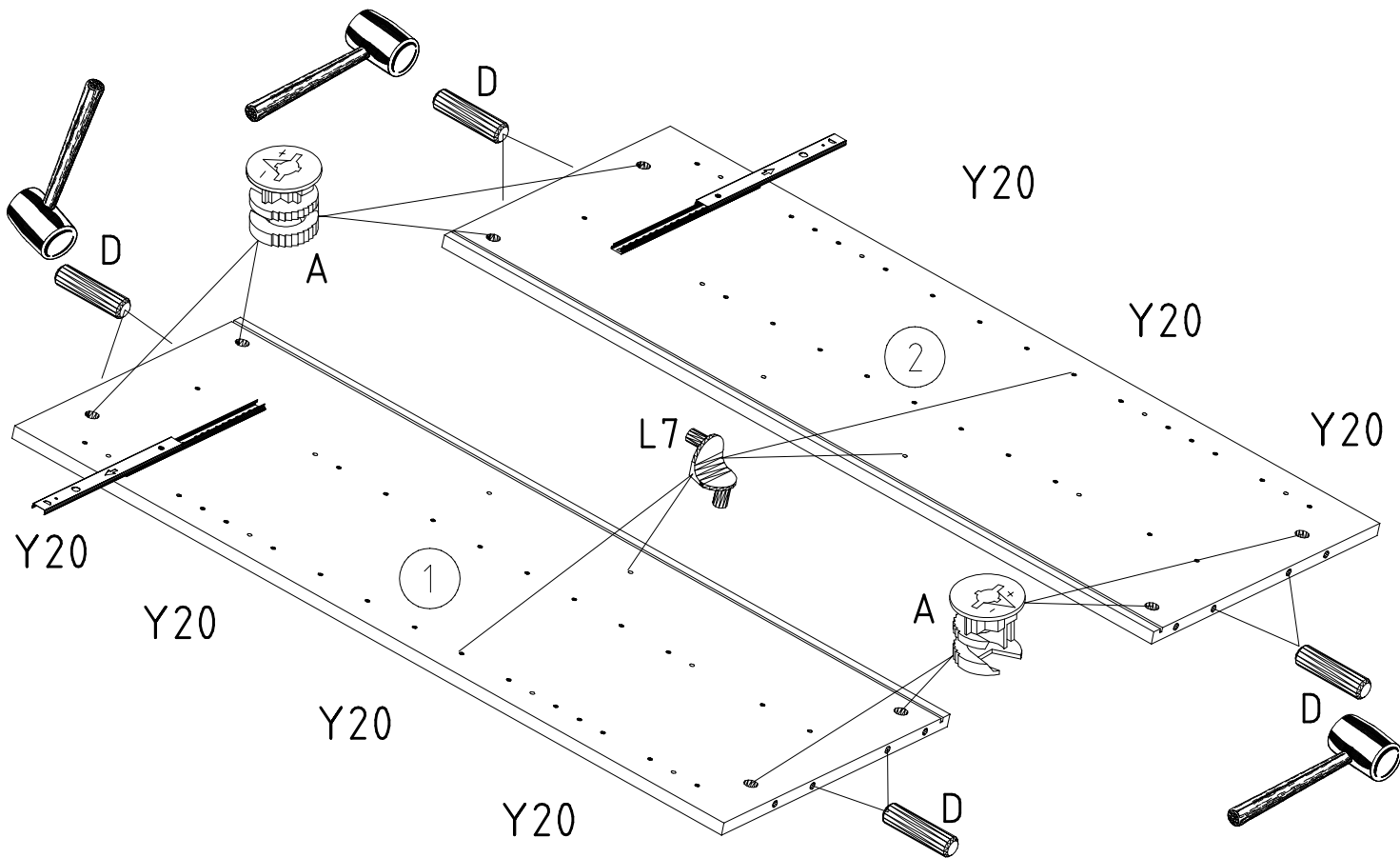
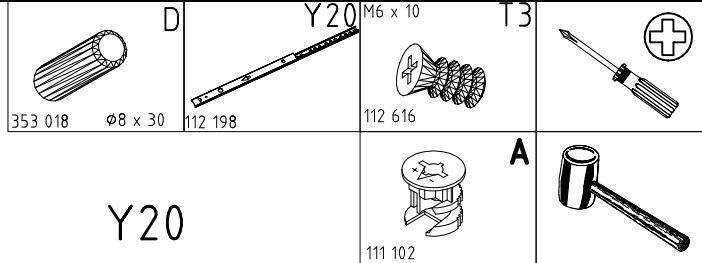

2

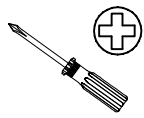

SG 25 4 X 23 mm SP23
121117

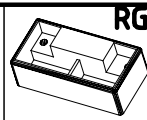
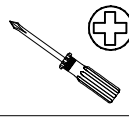

SG 25 4 X 23 mm SP23
121117

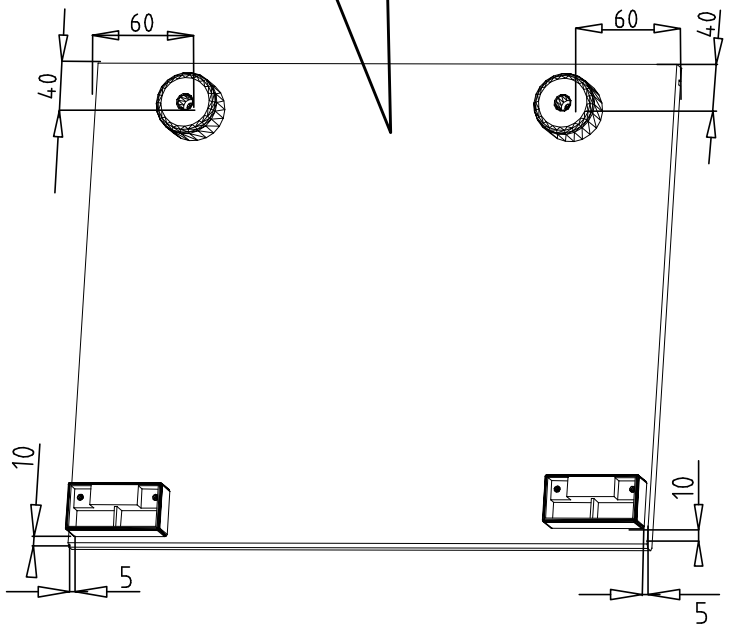
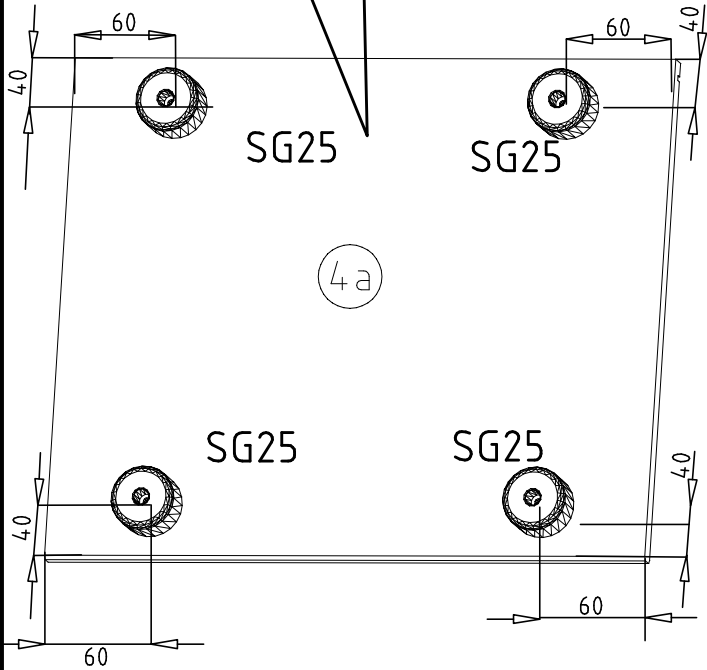
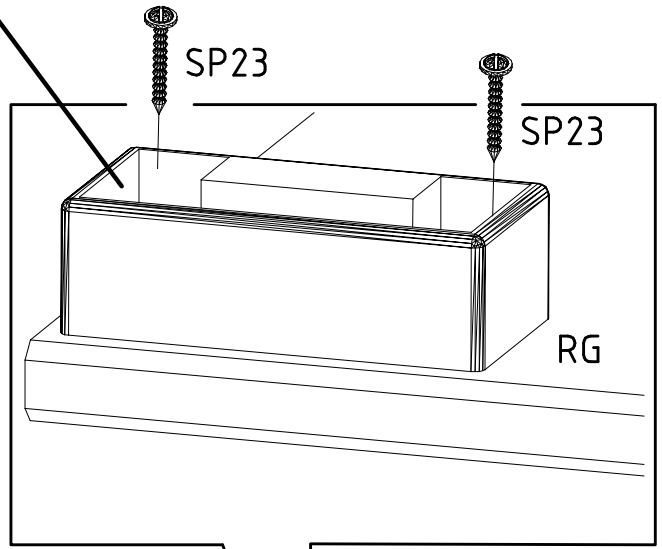
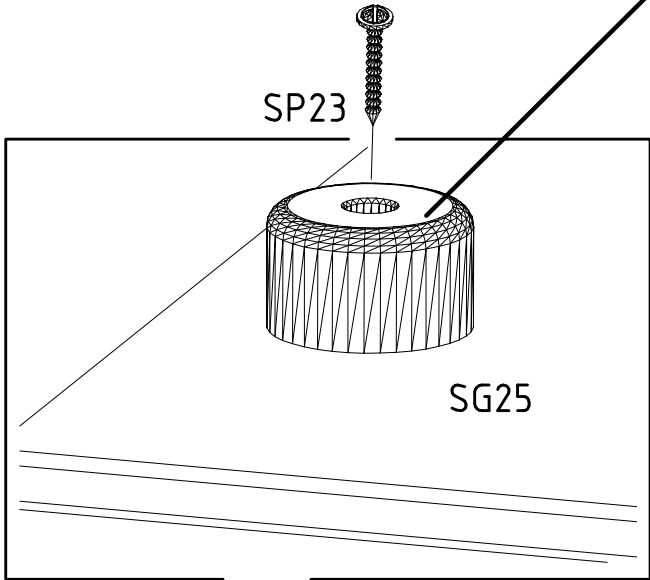
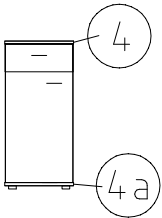

3

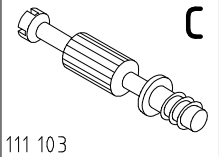
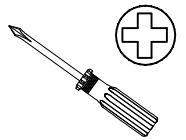
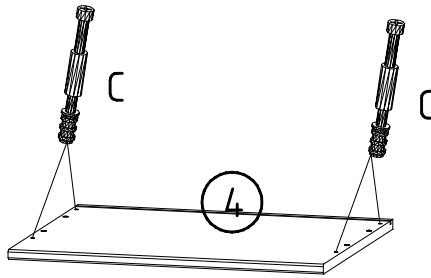
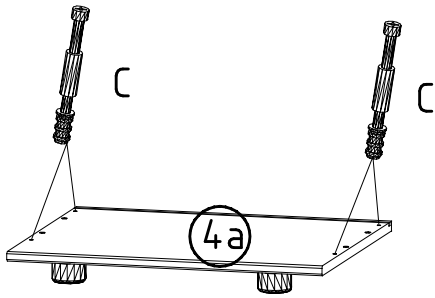

111 103

4

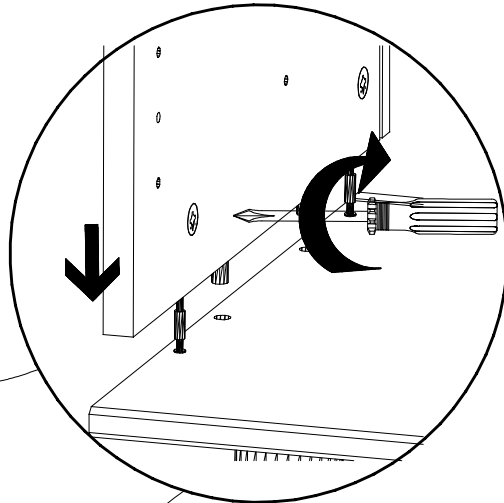
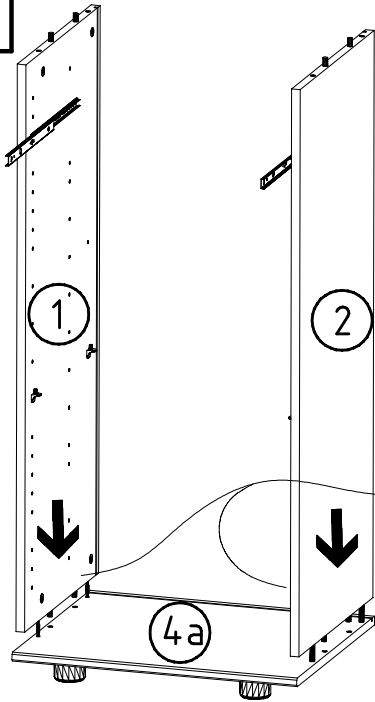

5

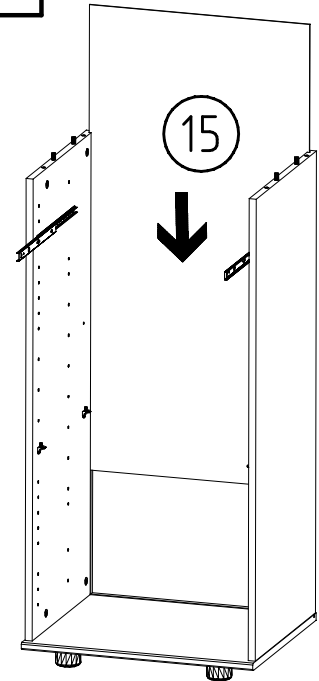

6

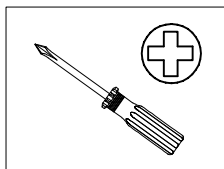
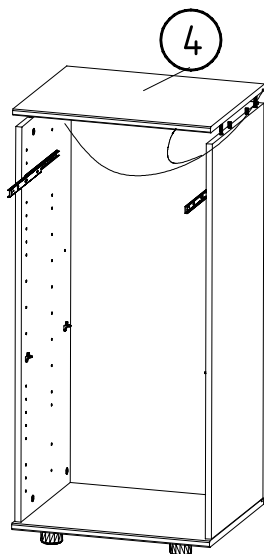

7

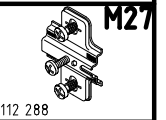
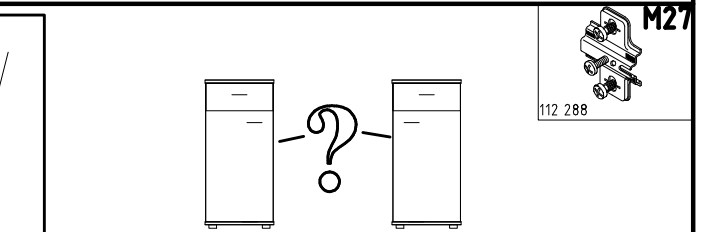
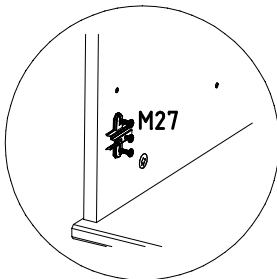
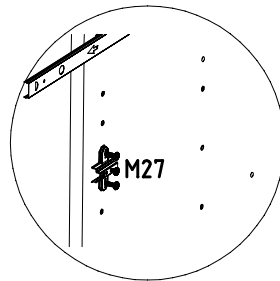
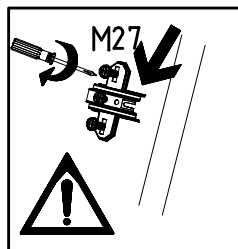

112 288

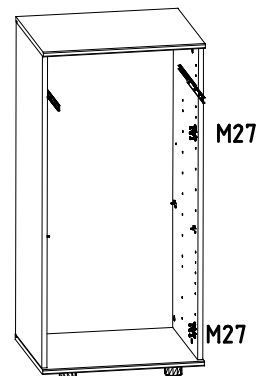
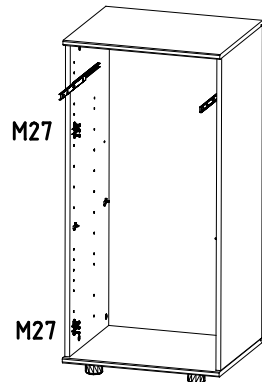

980210

19.08.15 /03.05.24

05 24

5/9

8

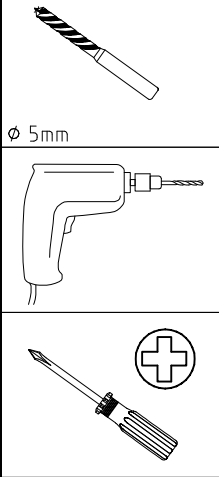
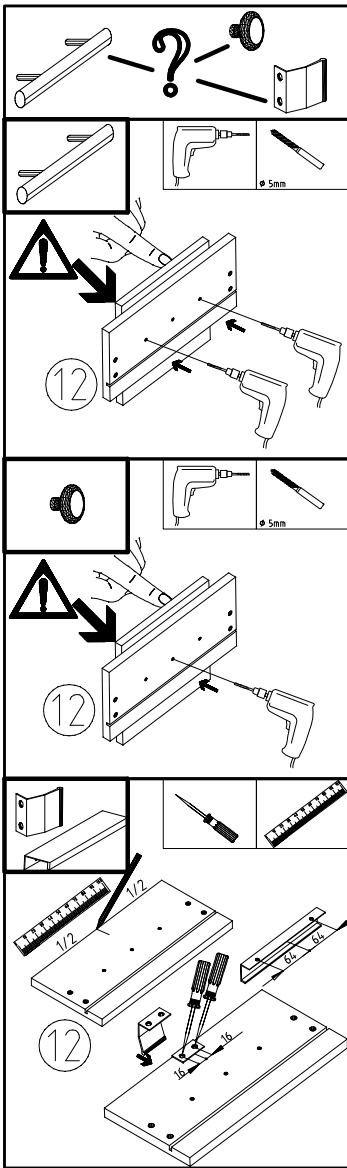

9

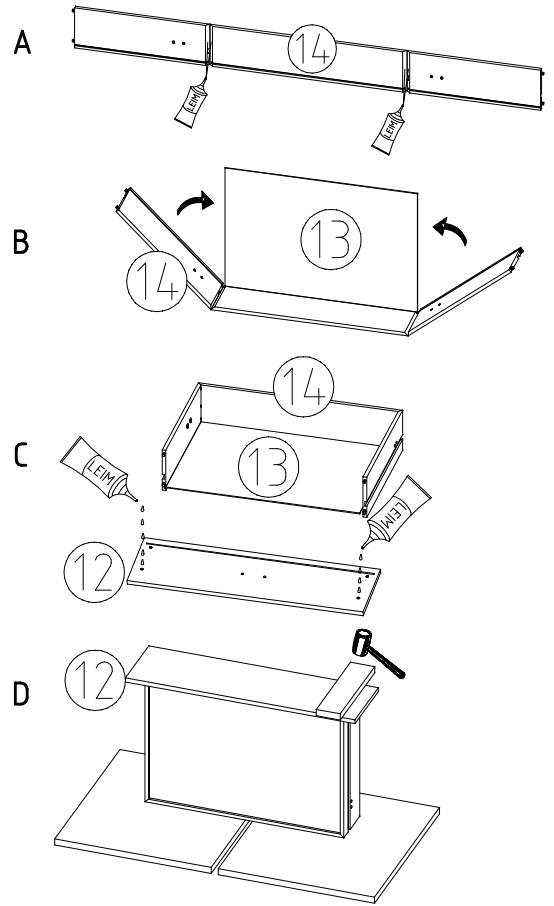
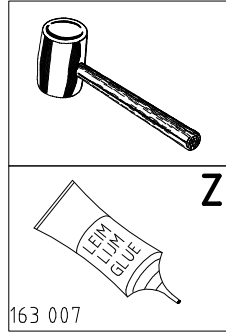

10

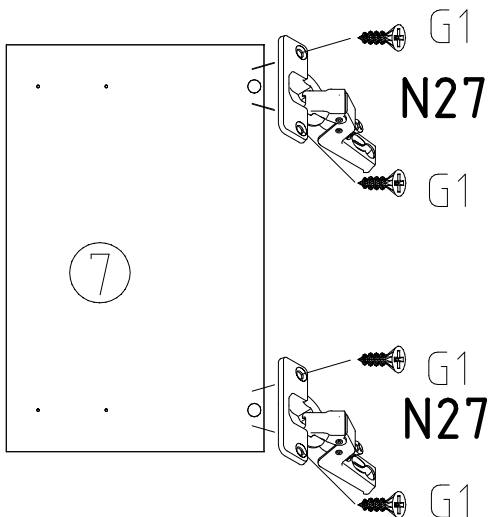
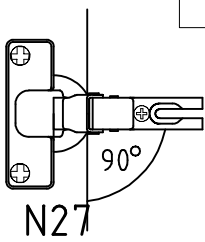
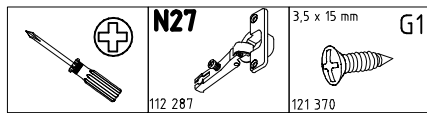

11

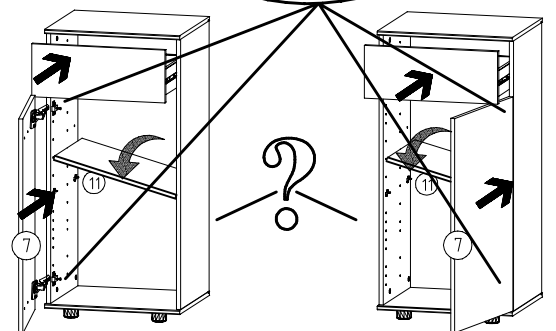
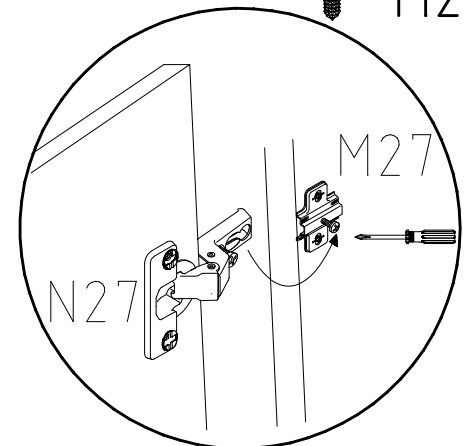
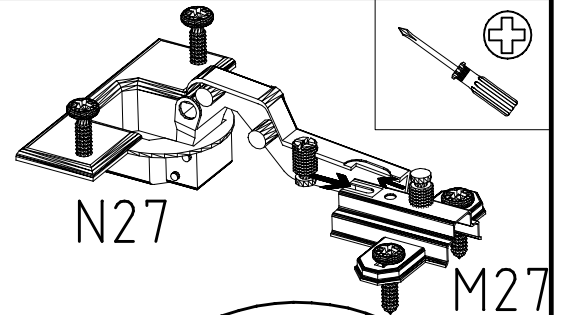

980210

19.08.15 / 03.05.24

05 24

6/9

12

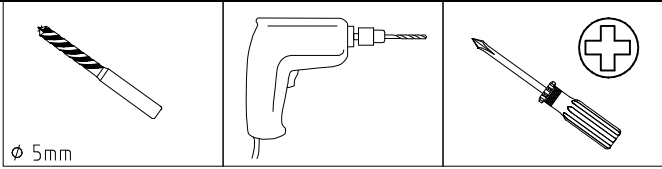

∅ 5mm

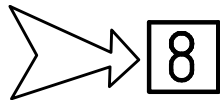
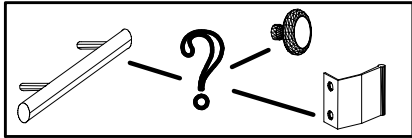
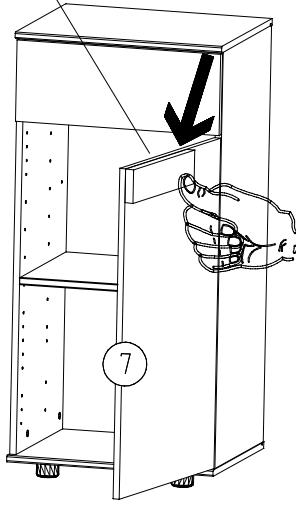
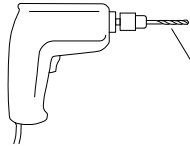

8

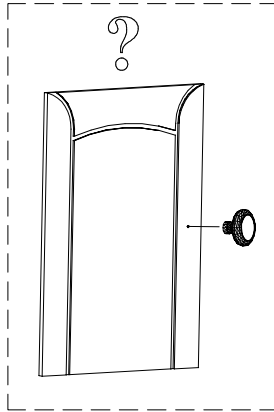

13

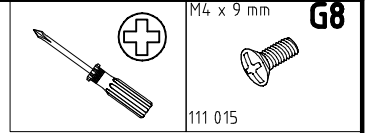

111 015

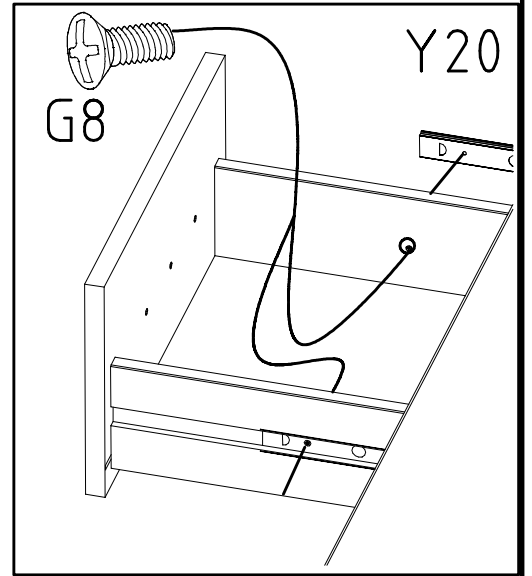

G8

Y20

14

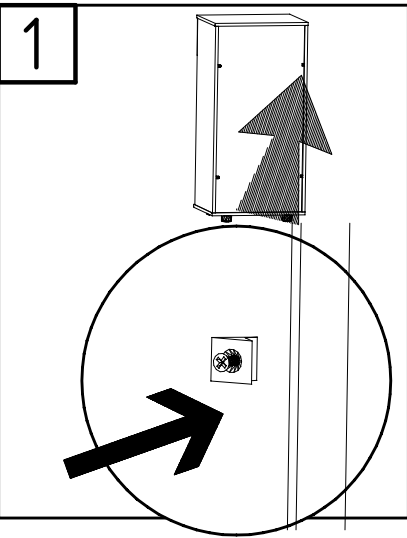

1

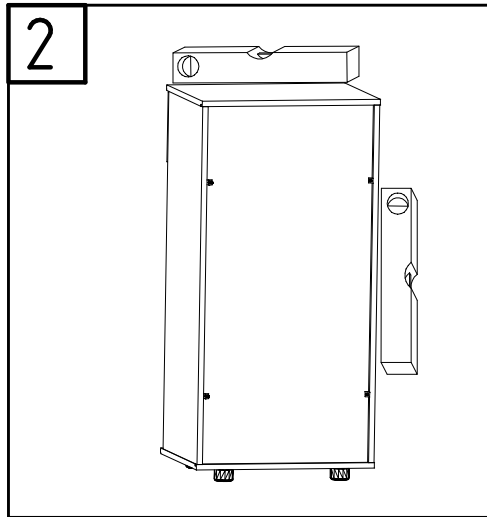

2

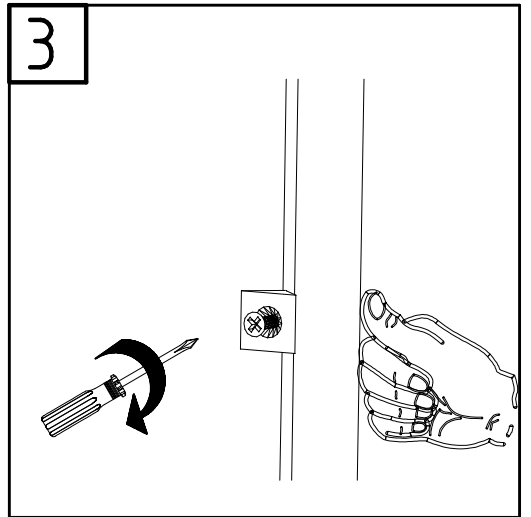

3

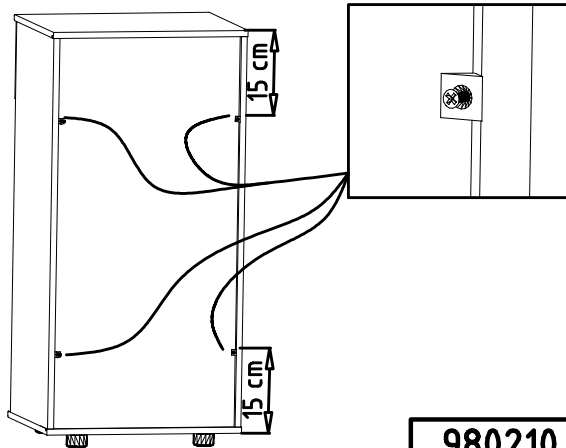
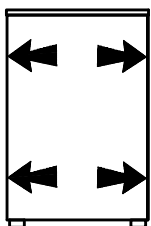

15 cm

15 cm

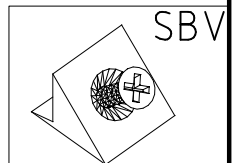

SBV

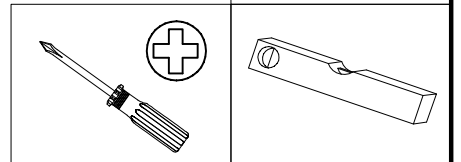

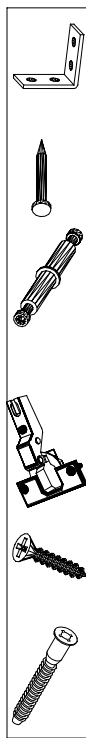
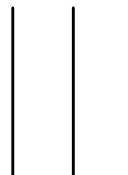
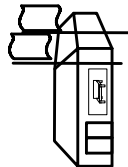
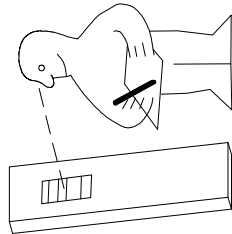
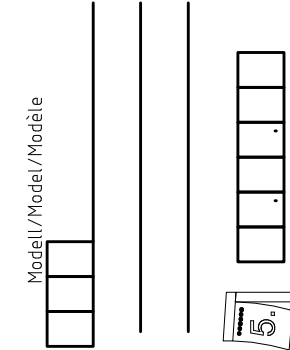
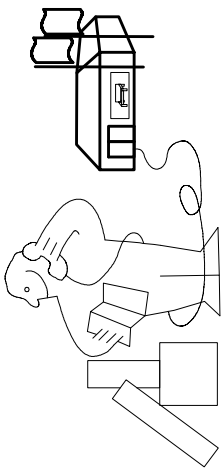
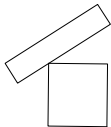
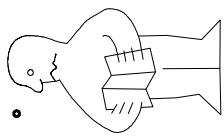

<121 370>	< G 1 >	<4x>

Anderungen die dem technischen Fortschritt geschuldet sind, behalten wir uns vor!
 Bei nicht vorschriftsmäßiger und/ oder nicht fachmännischer Montage wird bei Personen- und/ oder Sachschäden keinerlei Haftung übernommen.

made by

TOUP-NO. / TOUP-NO.	BOX-NO. / BOX-NO.	AUTRAG / ORDER-NO. / NO. DE COMMANDE
23203	30110XY	
Kunde / Customer / Client MAX MUSTERMANN		
Kommission / your order reference / votre reference 3377 MINDEN		
Dekor / Decor / Décor / Modell / Model / Modèle F99 SAMPLE		
F99842 SCHWEBTÜRENSCHRANK 250 CM H 216CM PLANKENEICHE NB + RAU STEEL PLANKENEICHE NACHBILDUNG		
Paket / Package / Paquet 414760 SOCKEL		
Paket / von 8		colli Kommission 10
HSP-SWIT BOD 50 TEXT/TEX SOCKEL 32 FRESH TV / LIT SO-BOD TEXT RASTEX/ ZNBOD D18MM 1X KLSTA 104		
Montage - Anleitung	Laenge 520,0 Breite 568,0	
KS-64		
SOCKEL32 KLEB		



104
 OBEN
 5
 30/19
 HAUT
 23.08.19
 SOUVENIR / 1.
 ABOVE
 OBEN

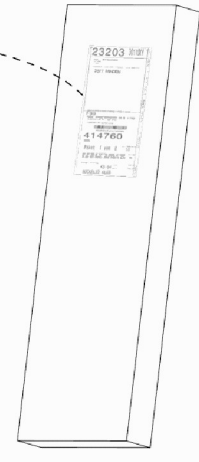

WIMEX Wohnbedarf	
Import Export Handelsges mbH & Co. KG	
Werner-von-Siemens-Str. 35	
D-49124 Georgsmarienhütte - Germany	
SAMPLE	23.08.19
Modellname	Produktionsdatum
Model	Date of manufacture

