

**D** MONTAGEANLEITUNG  
BEDIENUNGSANLEITUNG

**NL** HANDLEIDING VOOR DE MONTAGE  
GEBRUIKSAANWIJZING

**TR** MONTAJ TALIMATI  
KULLANIM KLAVUZU

**RO** INSTRUCȚIUNI DE INSTALARE  
INSTRUCȚIUNI DE UTILIZARE

**FR** NOTICE DE MONTAGE  
MANUEL INSTRUCTIONS

**HU** KÖZGYŰLÉS UTASÍTÁSOK  
KEZELÉSI UTASÍTÁS

**SI** NAVODILA ZA MONTAŽO  
NAVODILA ZA UPORABO

**ES** INSTRUCCIONES DE MONTAJE  
MANUAL DEL USUARIO

**GB** ASSEMBLY INSTRUCTIONS  
INSTRUCTION MANUAL

**PL** INSTRUKCJA MONTAŻU  
INSTRUKCJA OBSŁUGI

**RU** ИНСТРУКЦИЯ ПО МОНТАЖУ  
ИНСТРУКЦИЯ ПО ЭКСПЛУАТАЦИИ

**IT** ISTRUZIONI DI MONTAGGIO  
MANUALE DI ISTRUZIONI

**SK** MONTÁŽNY NÁVOD  
NÁVOD NA POUŽITIE

**CZ** MONTÁŽNÍ NÁVOD  
NÁVOD K POUŽITÍ

**PT** INSTRUÇÕES DE MONTAGEM  
MANUAL DO USUÁRIO

**HR** UPUTE ZA MONTAŽU  
UPUTE ZA UPOTREBU

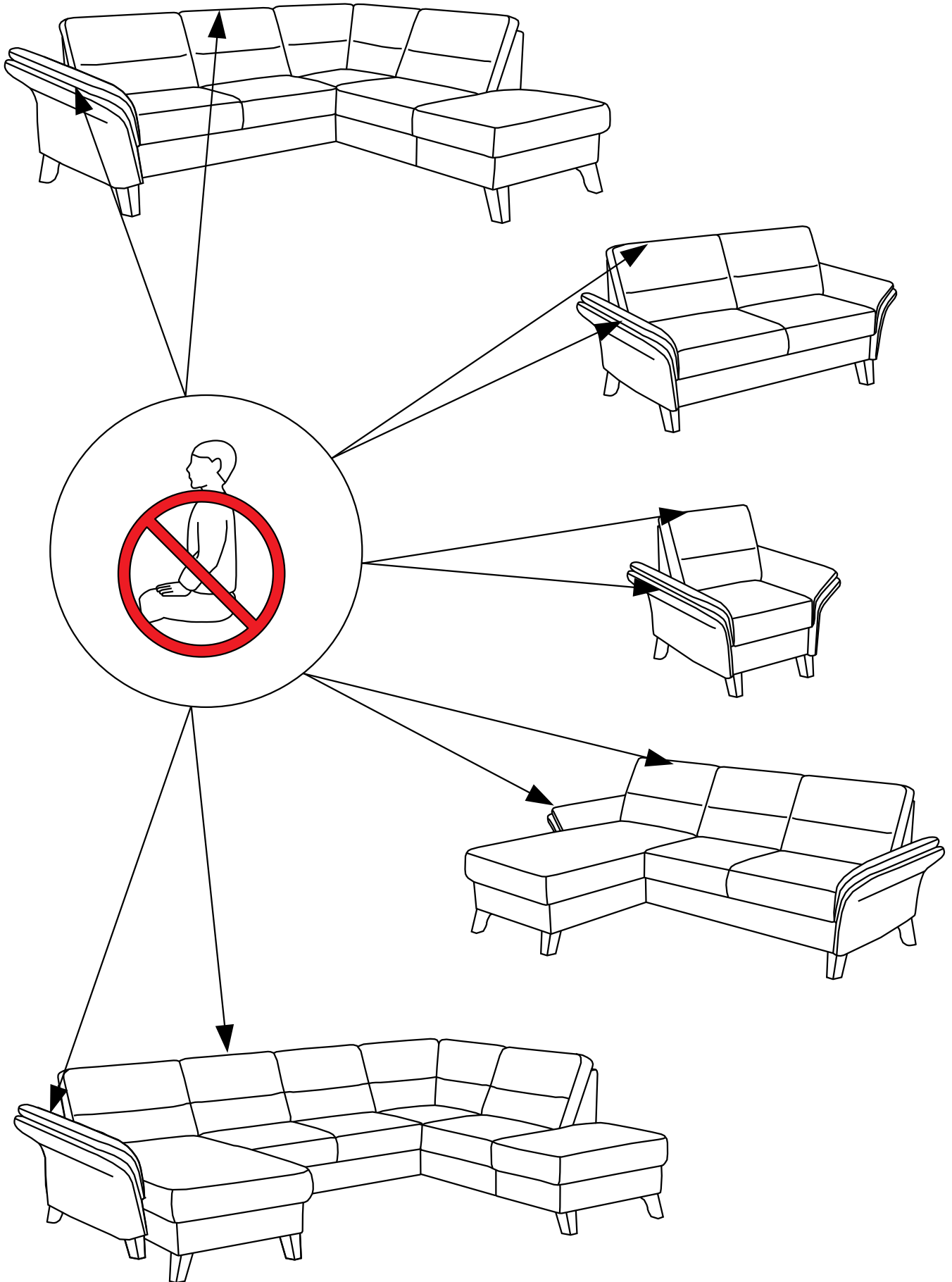

Name · Naam · Nazwa · Ísim · Название · Nume · Nome · Názov · Názov ·  
 Název · Neve  
**WESTERLAND**  
 Typ · Type · Tip · Тип · Tipo · Típus

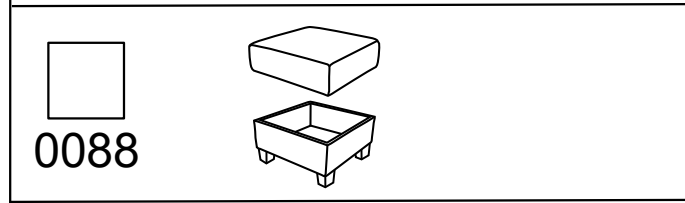
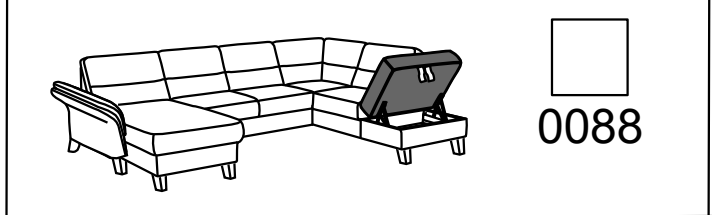
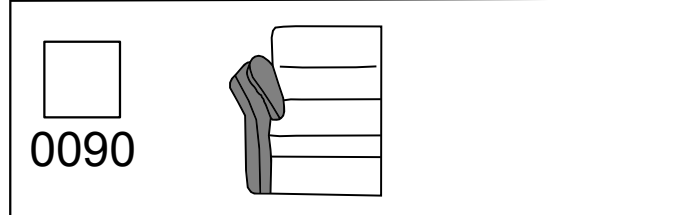
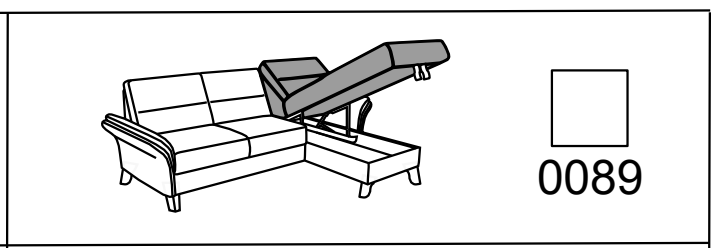
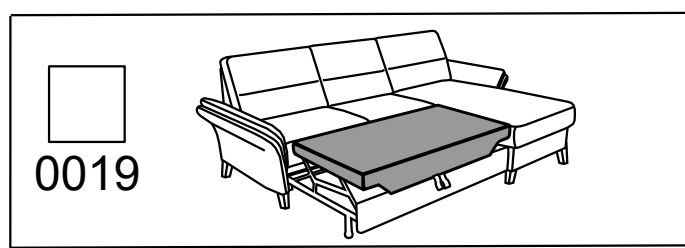
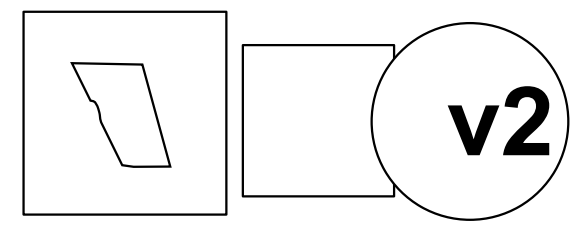
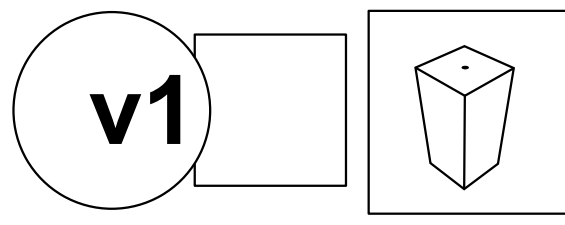
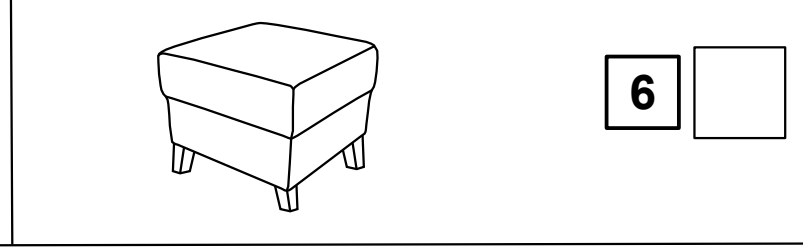
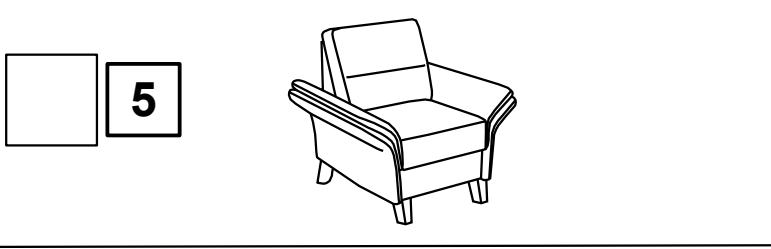
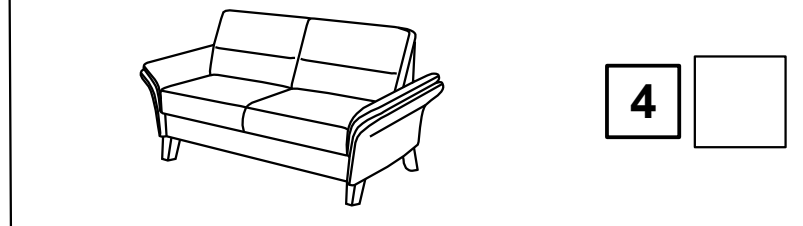
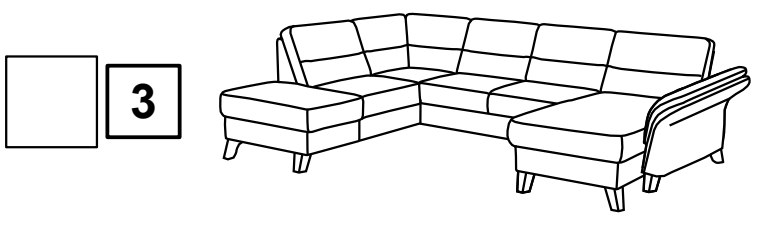
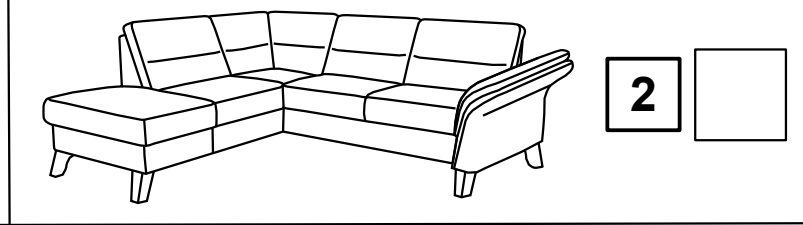
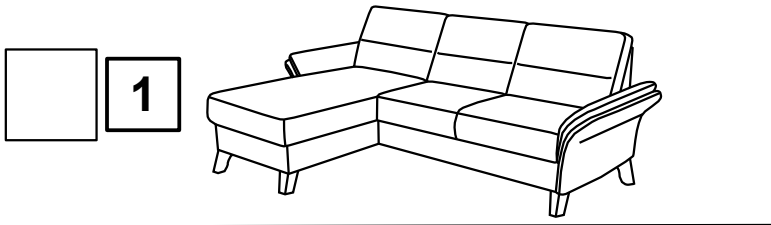
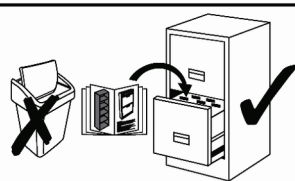







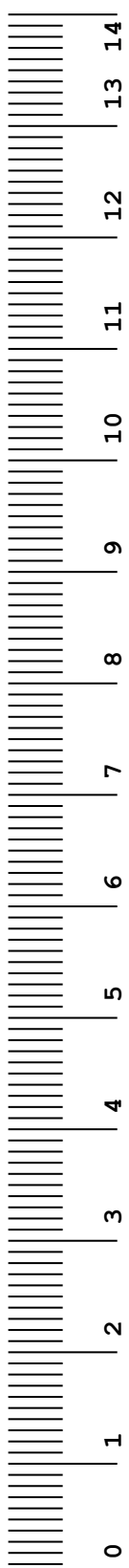
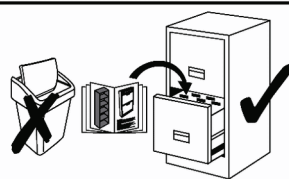

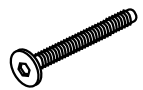
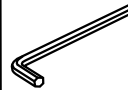
Name · Naam · Nazwa · Ísim · Название · Nume · Nome · Názov · Názov ·  
 Název · Neve

**WESTERLAND**

Typ · Type · Tip · Тип · Tipo · Típus

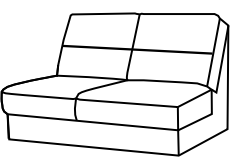

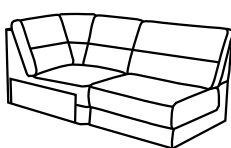
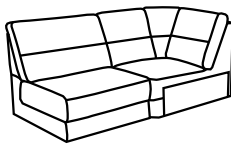
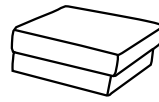
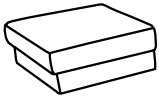







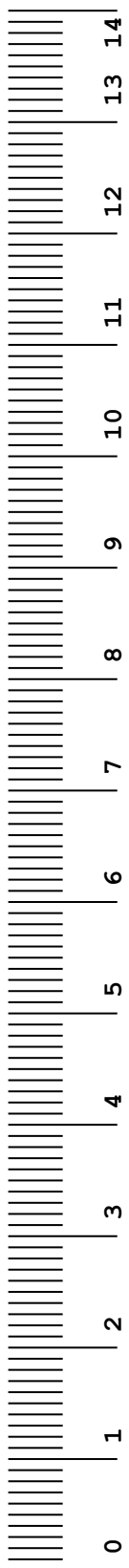
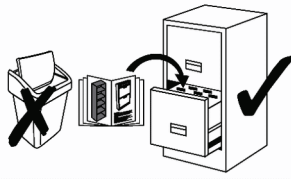

	<b>v1</b>	a 	b M8x110 	c L-5 	d 	e 	f 
<b>(A-1)</b> 							
<b>(A-2)</b> 	2	2			2	-	-
<b>(B)</b> 	-	-			-	-	-
<b>(C-1)</b> 							
<b>(C-2)</b> 	4	4	1		4	1	1
<b>(D-1)</b> 							
<b>(D-2)</b> 	1	1			1	1	3
<b>(E-1)</b> 							
<b>(E-2)</b> 	2	2			2	-	-

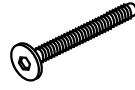
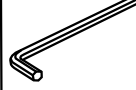
Name · Naam · Nazwa · Ísim · Название · Nume · Nome · Názov · Názov ·  
 Název · Neve

**WESTERLAND**

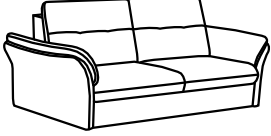
Typ · Type · Tip · Тип · Tipo · Típus

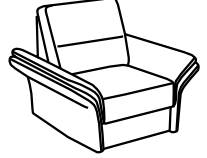

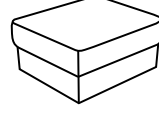
		a 	b M8x110 	c L-5 	d 	e 	f 
 	4	4	1	4	-	-	
 	4	4		1	4	-	-
 	4	4		4	-	-	

Name · Naam · Nazwa · Ísim · Название · Nume · Nome · Názov · Názov ·  
 Název · Neve

**WESTERLAND**

Typ · Type · Tip · Тип · Tipo · Típus

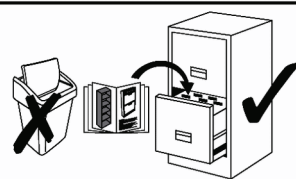





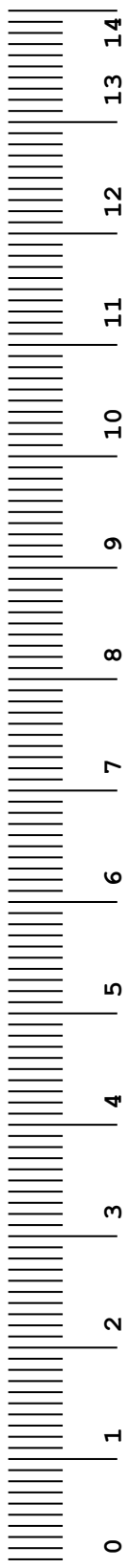
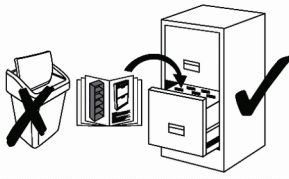

	<b>v2</b>	a	b M8x60	c L-5	d	e	f
14							
13							
12	<b>(A-1)</b>	2	2		2	-	-
11	<b>(A-2)</b>						
10							
9	<b>(B)</b>	-	-		-	-	-
8							
7	<b>(C-1)</b>						
6	<b>(C-2)</b>	4	4	1	4	1	1
5							
4	<b>(D-1)</b>						
3	<b>(D-2)</b>	1	1		1	1	3
2							
1	<b>(E-1)</b>						
0	<b>(E-2)</b>	2	2		2	-	-

Name · Naam · Nazwa · Ísim · Название · Nume · Nome · Názov · Názov ·  
 Název · Neve

**WESTERLAND**

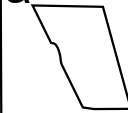
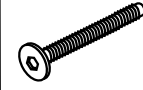
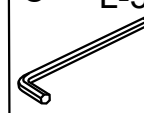
Typ · Type · Tip · Тип · Tipo · Típus

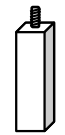

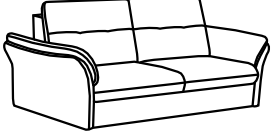
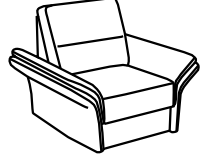
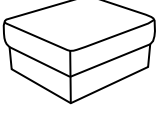
		a 	b M8x60 	c L-5 	d 	e 	f 
	<b>F</b>	4	4	<b>1</b>	4	-	-
	<b>G</b>	4	4		4	-	-
	<b>H</b>	4	4		4	-	-

1

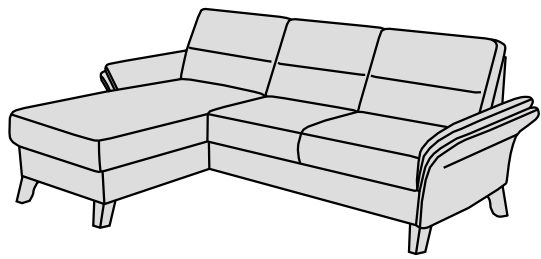
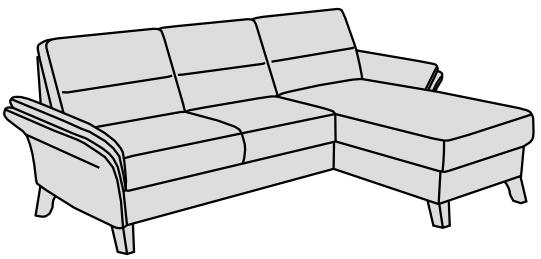

A-1

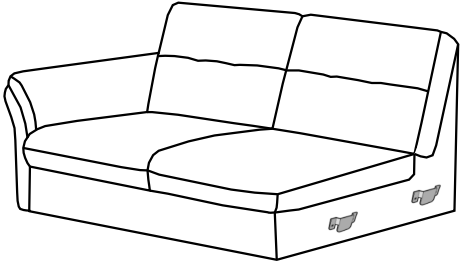

A-2



C-1

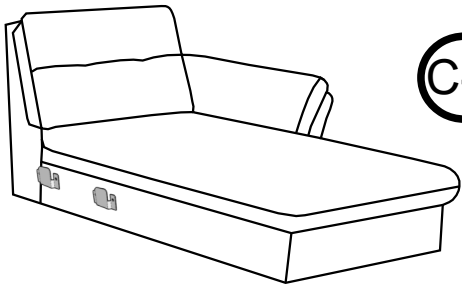

C-2

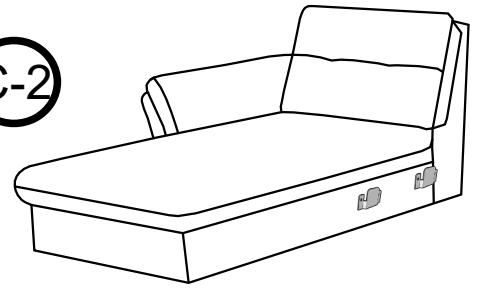

2

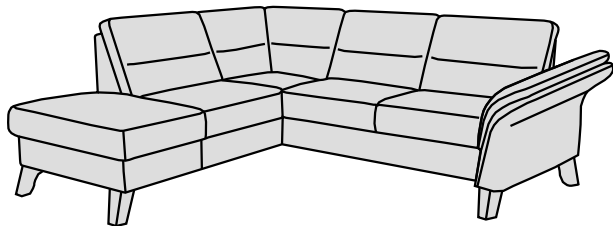
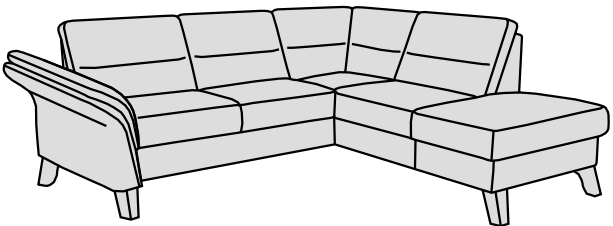

A-1

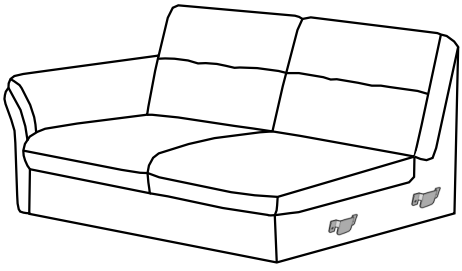

A-2

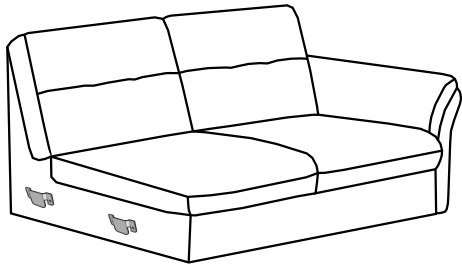

D-1

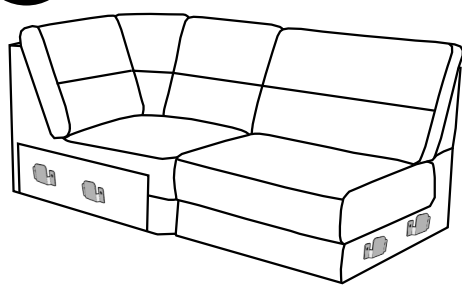

D-2

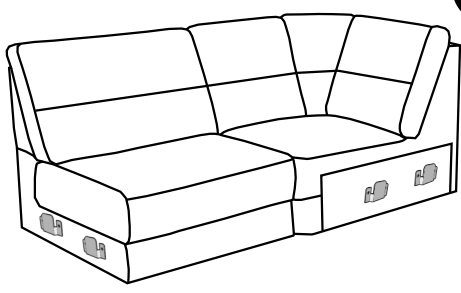

E-1



E-2





3

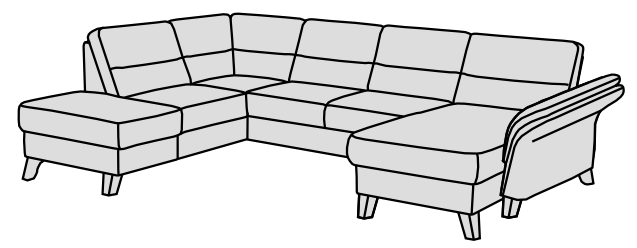
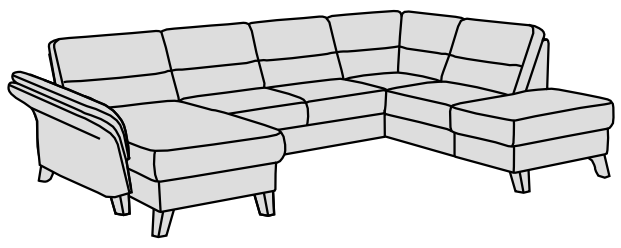

C-2

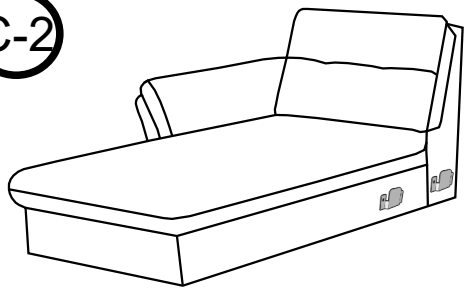

C-1

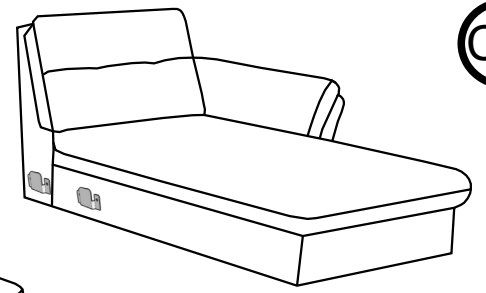

B

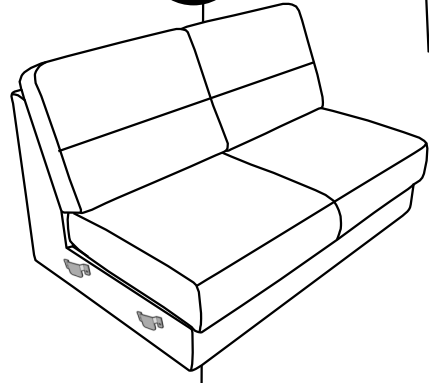

D-2

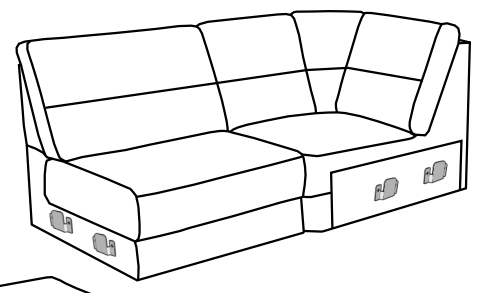

D-1

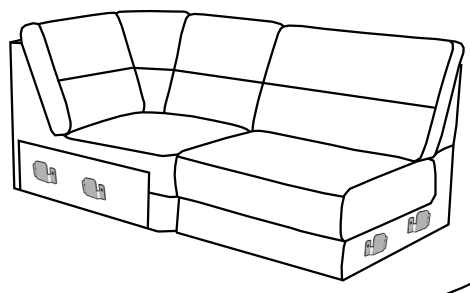

E-1

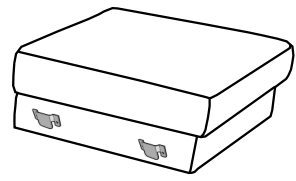

E-2



4

F

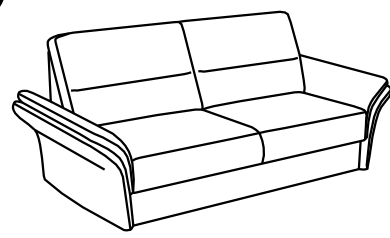
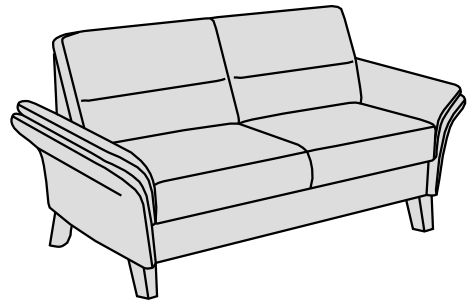

5

G

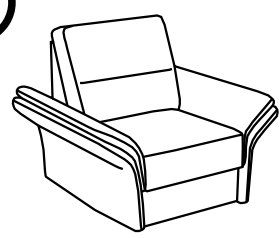
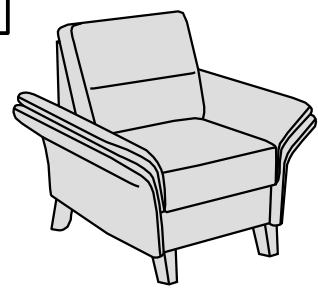

6

H

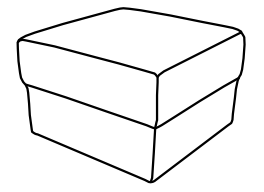
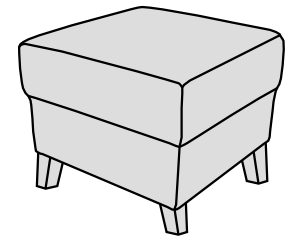

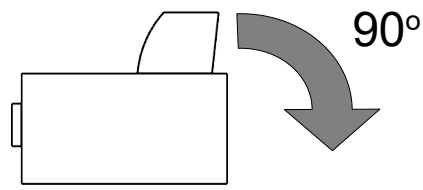

**v1**

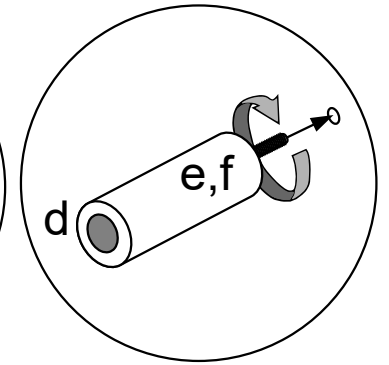
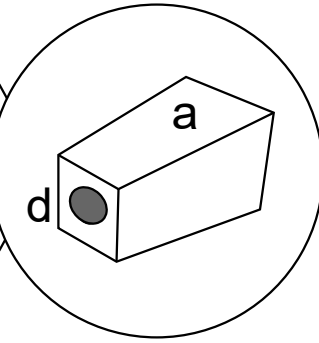
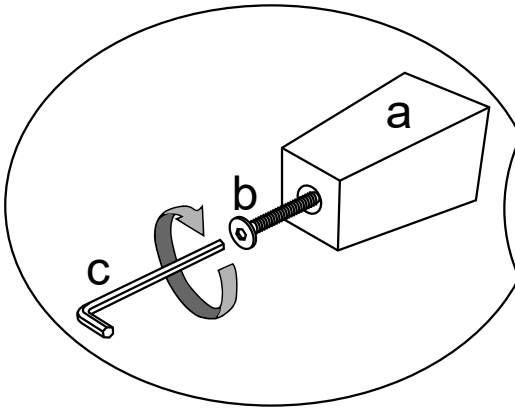

**v2**

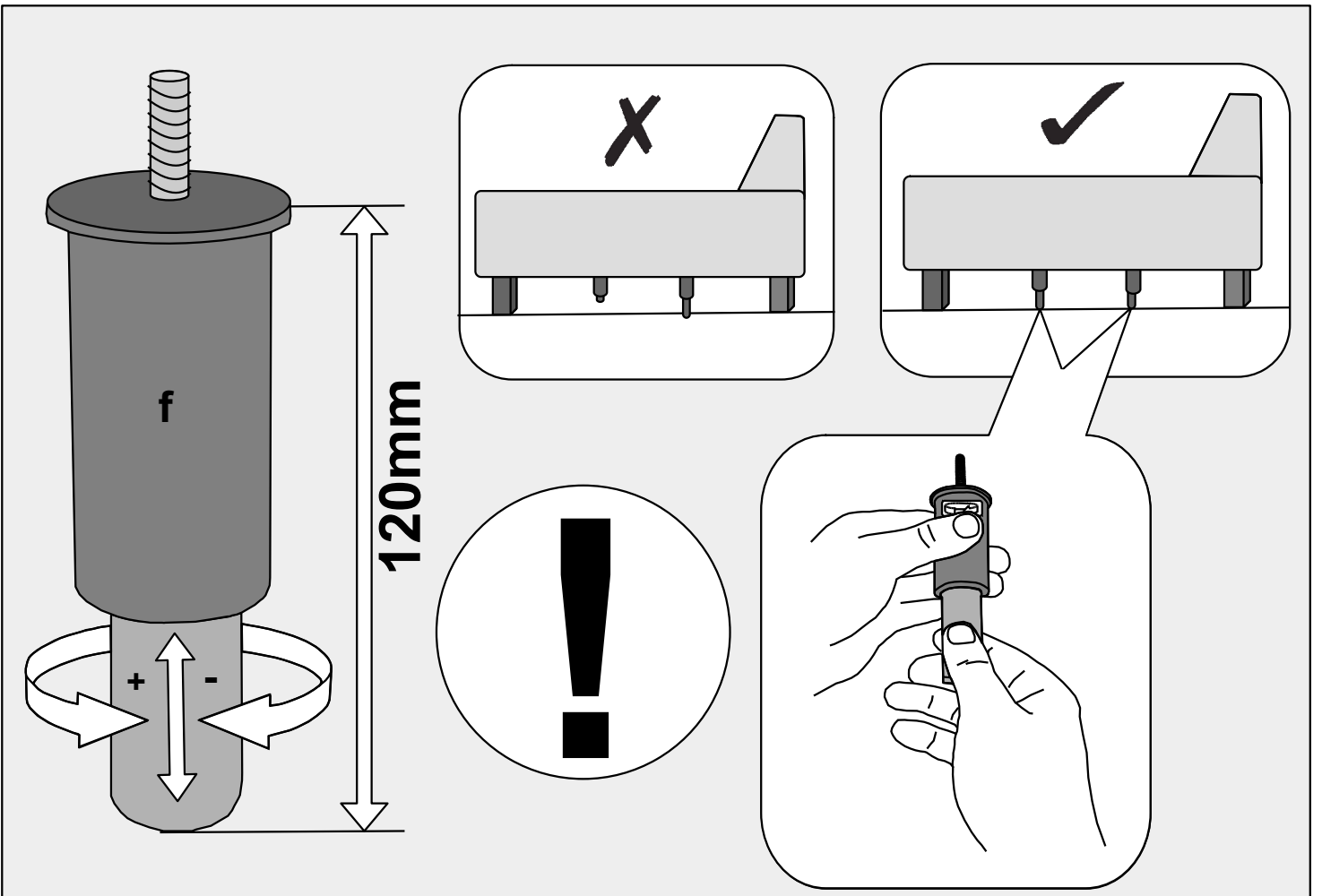
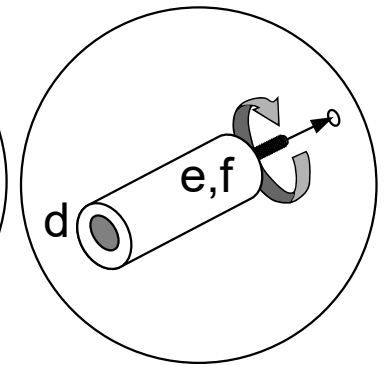
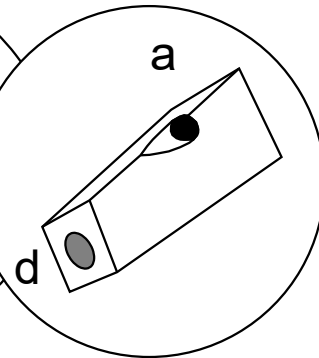
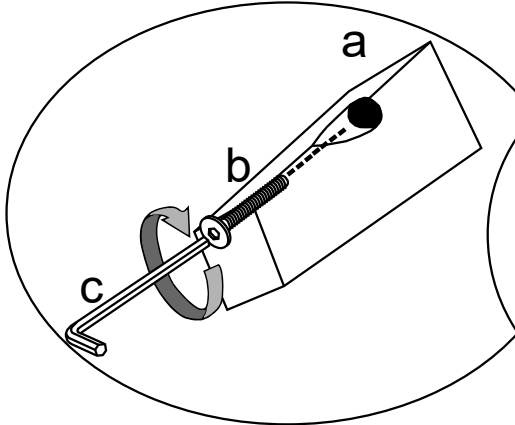

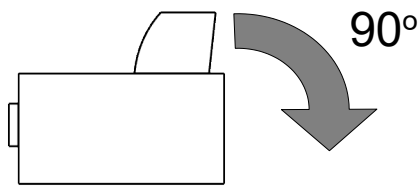

0089

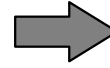
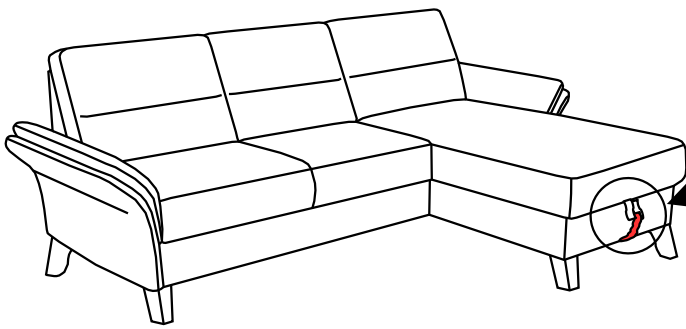
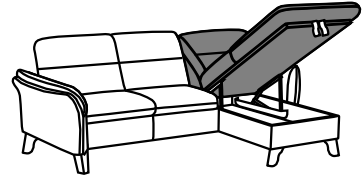
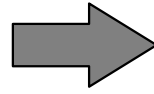
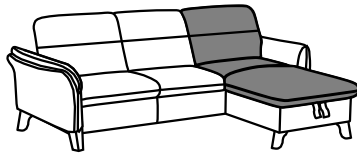

1

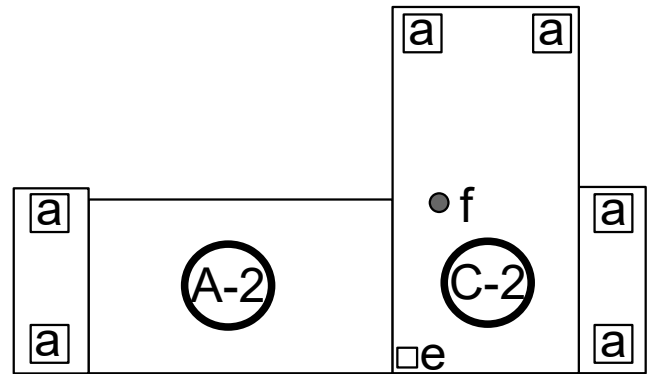
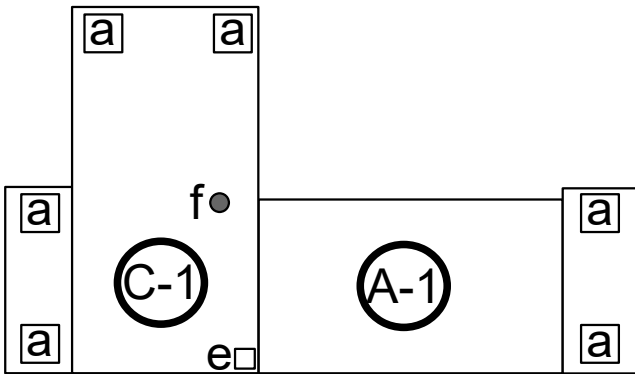
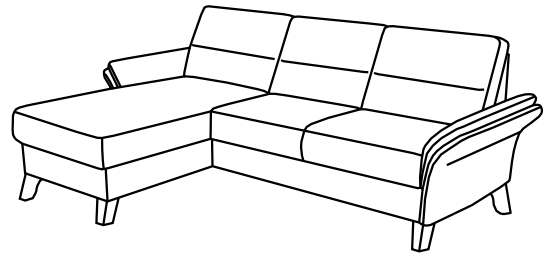
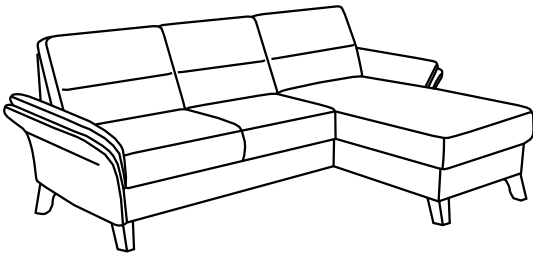

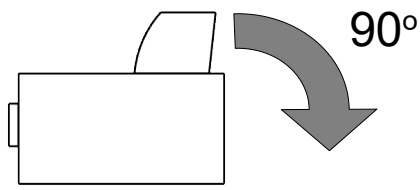

2

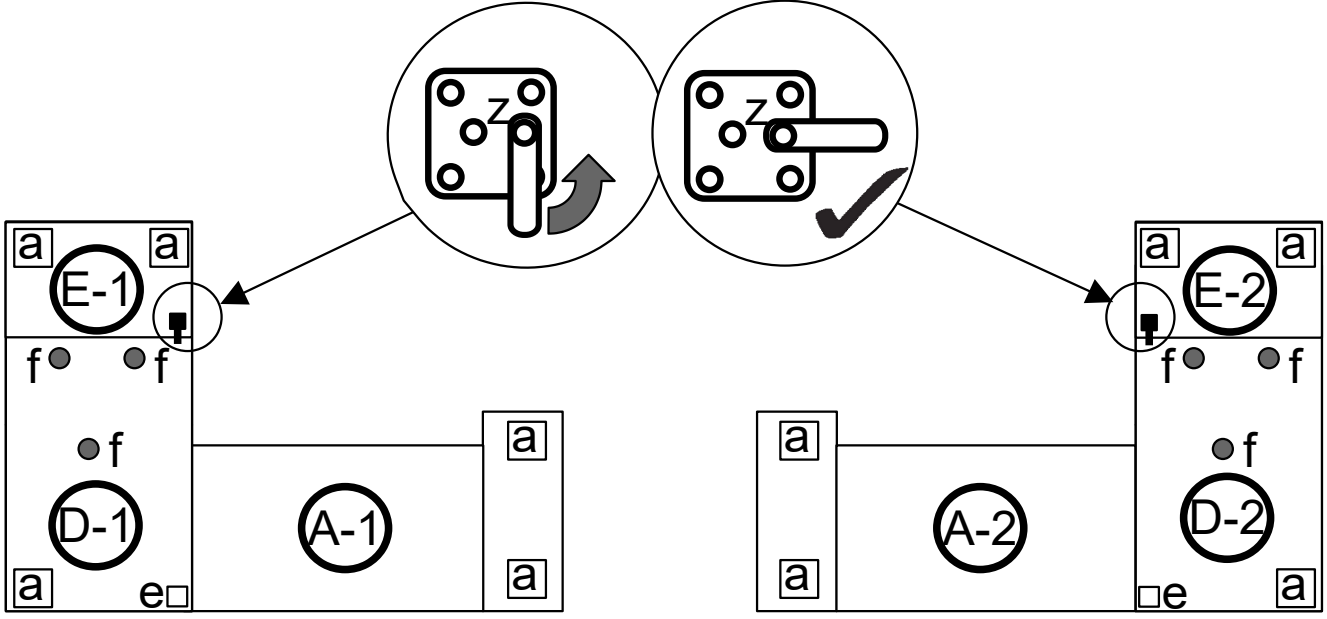
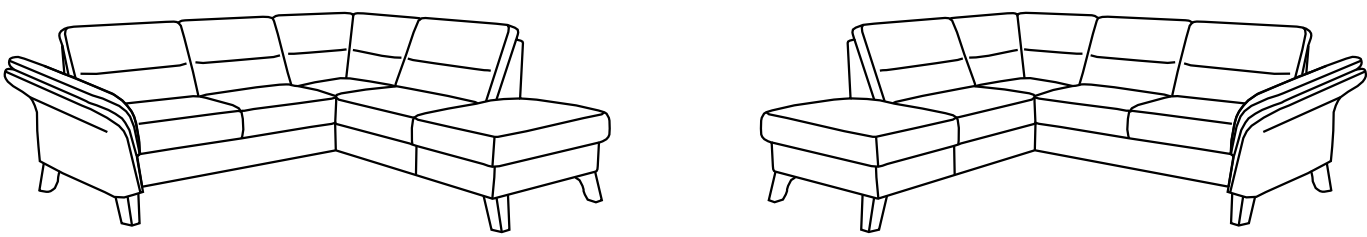

3

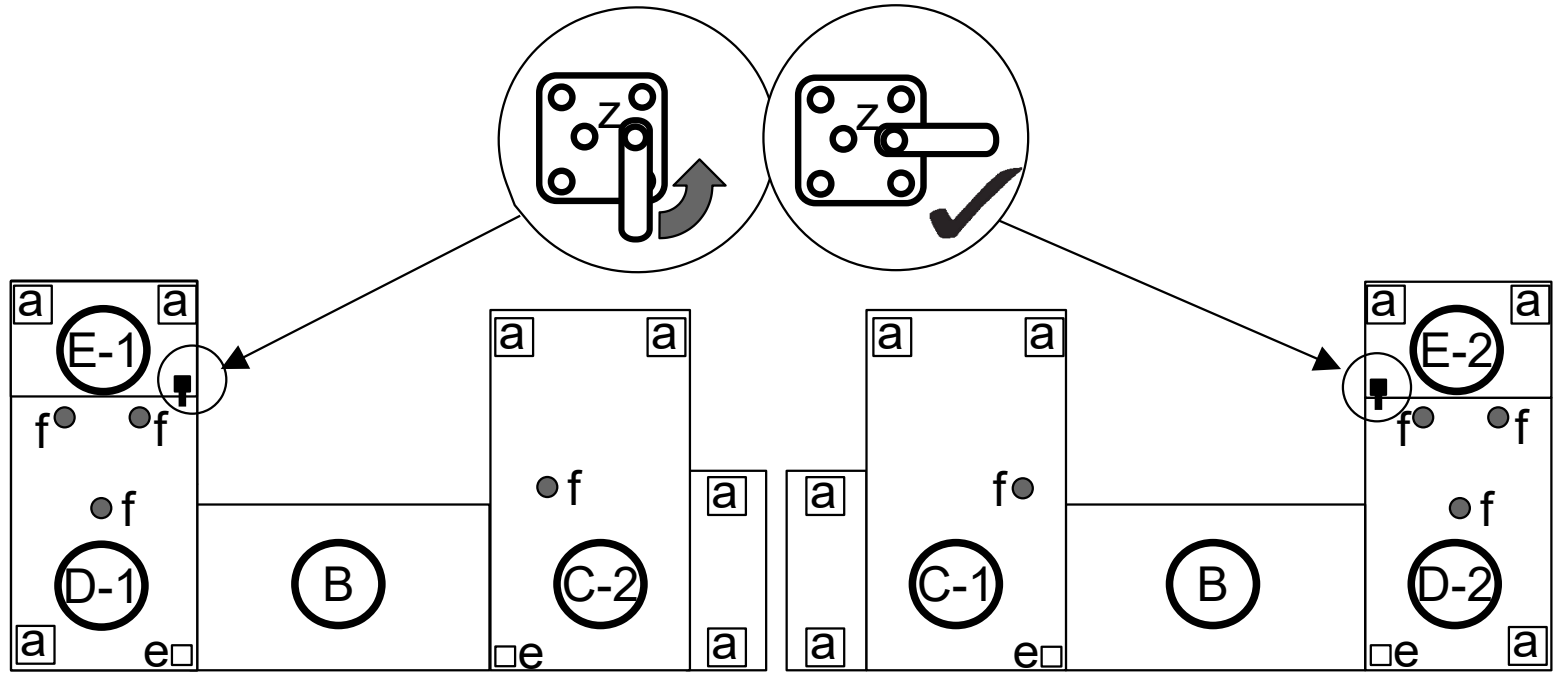
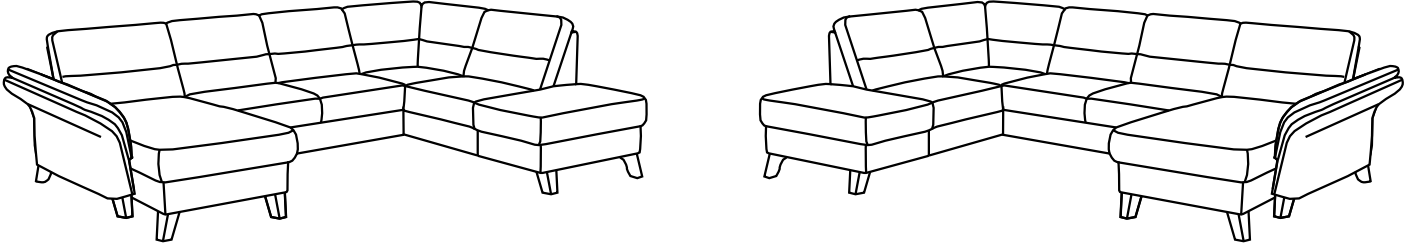

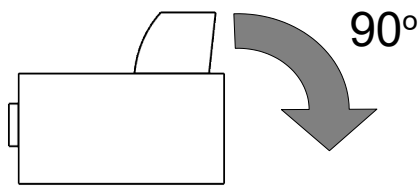

4

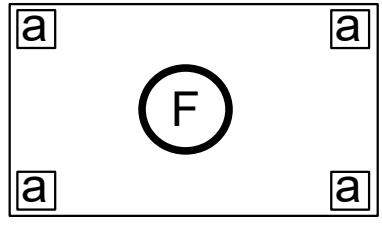
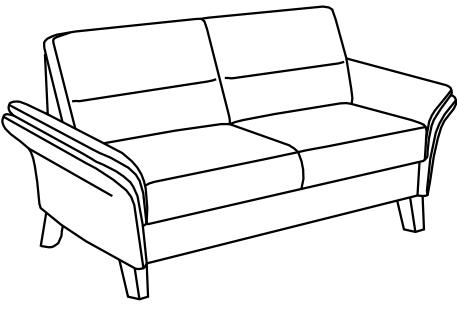

5

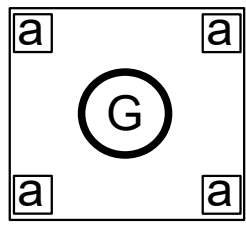
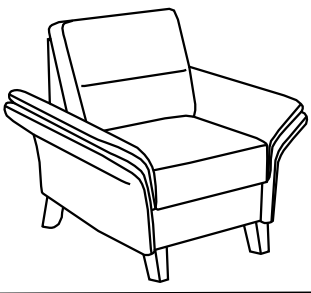

6

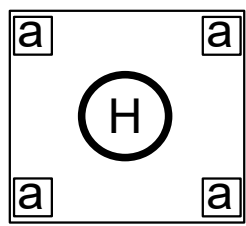
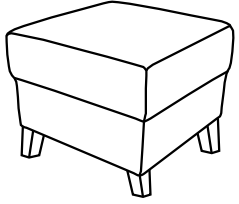

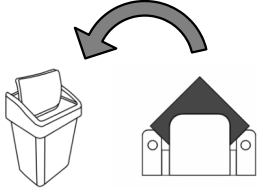

1

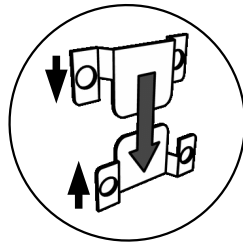
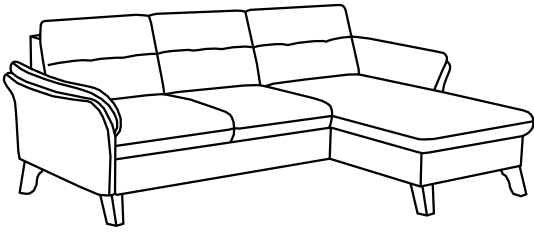

A-1

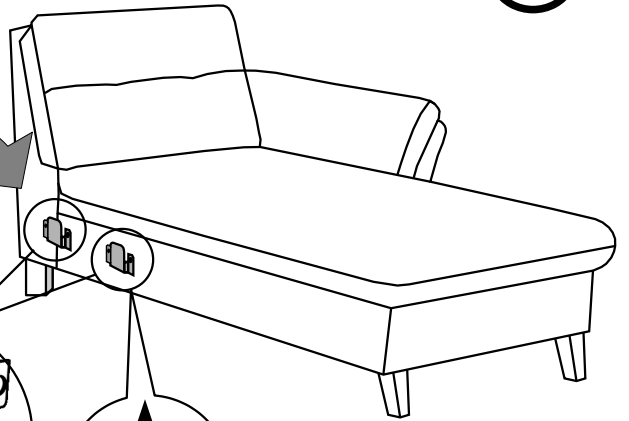
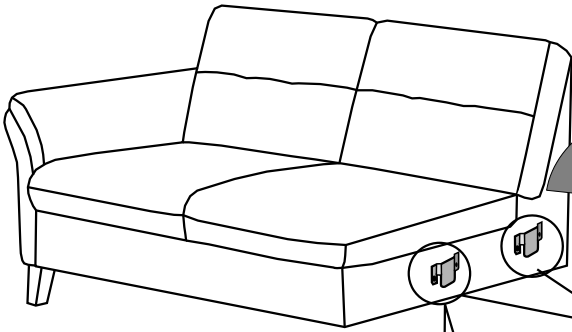

C-1

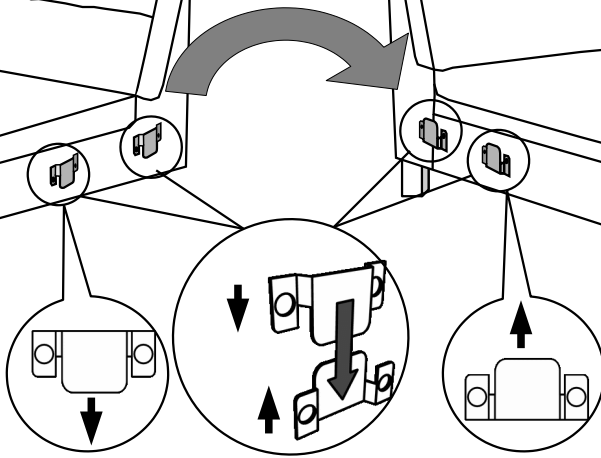

1

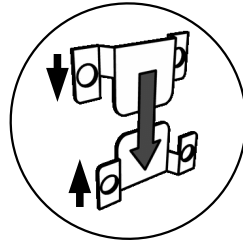
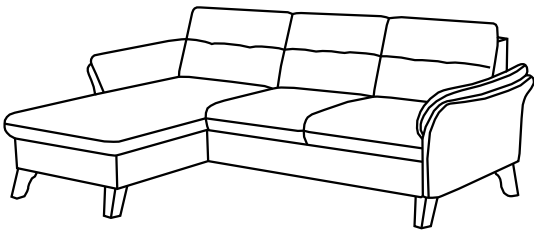

C-2

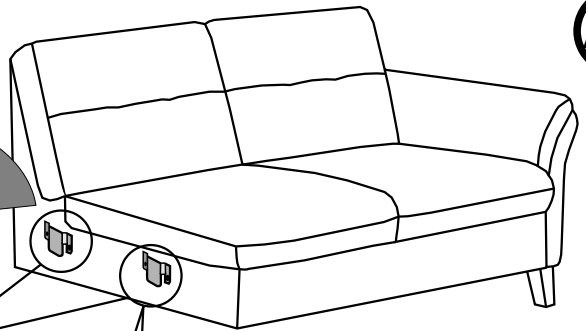
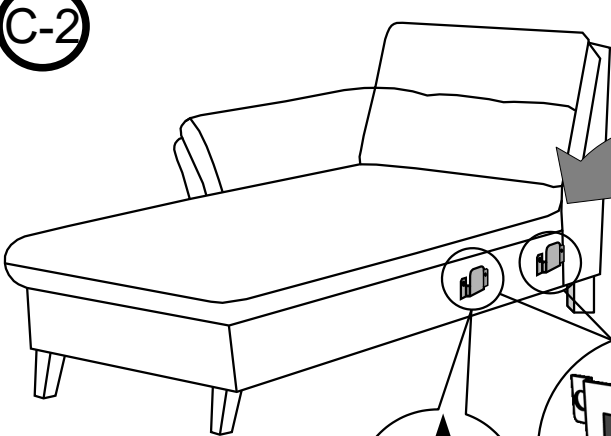

A-2

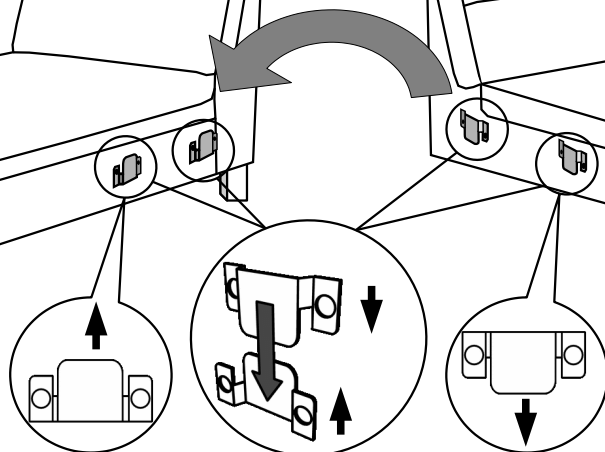

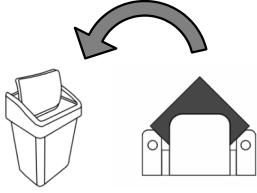

2

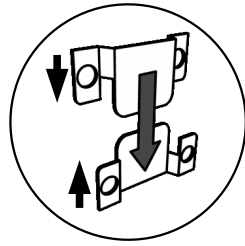
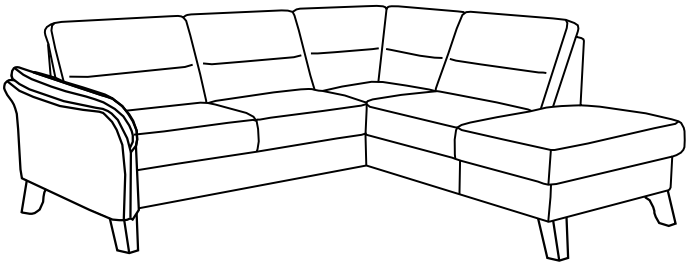

A-1

D-1

E-1

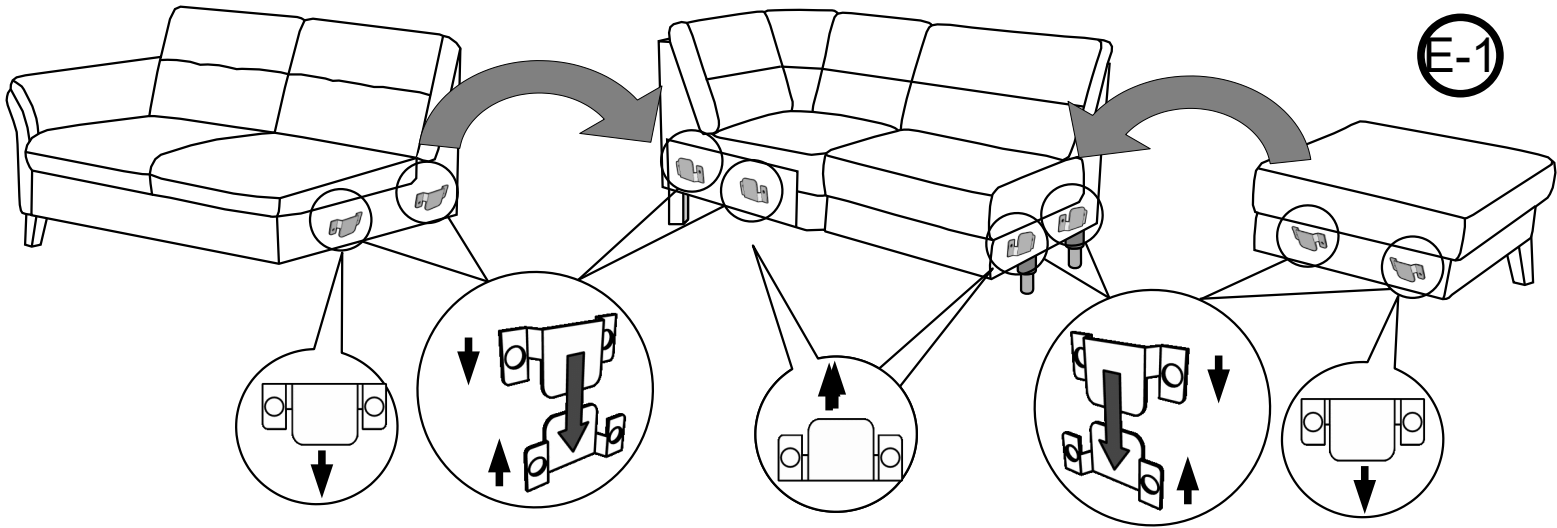

2

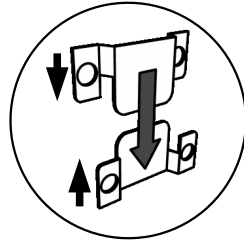
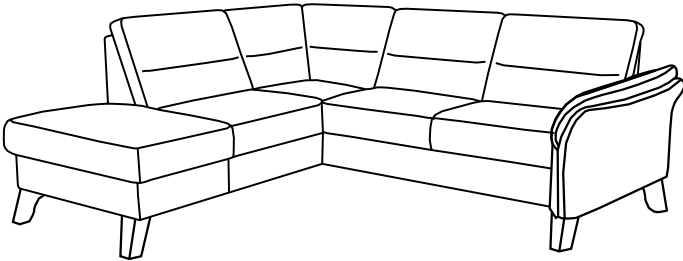

D-2

A-2

E-2

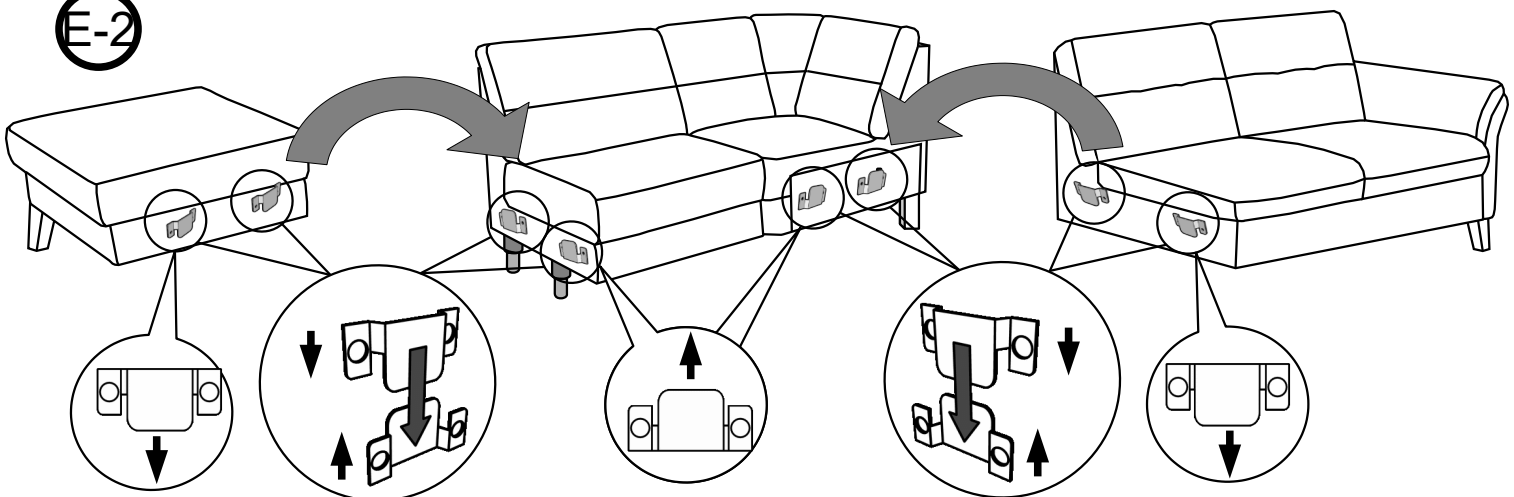

3

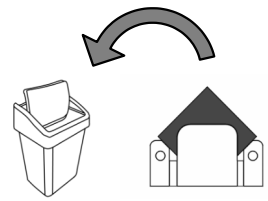
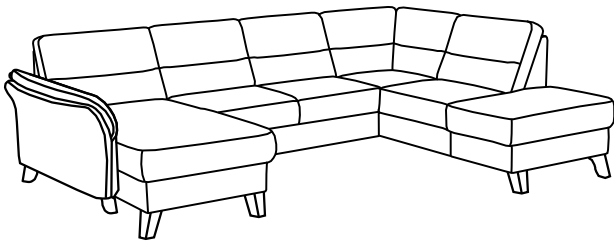

C-2

B

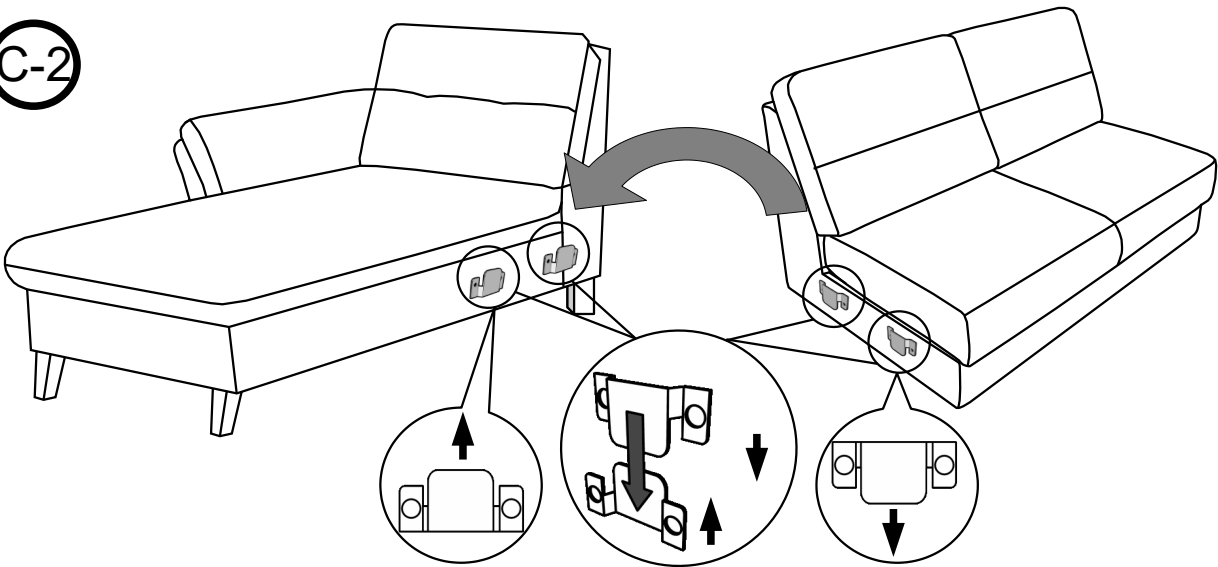

B

D-1

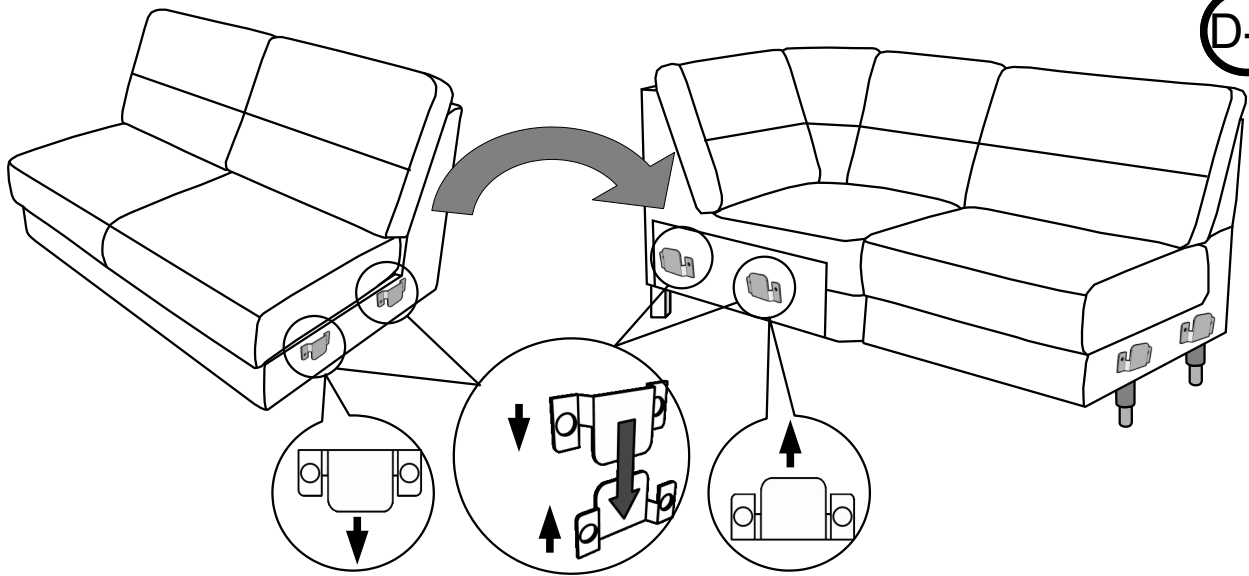

D-1

E-1

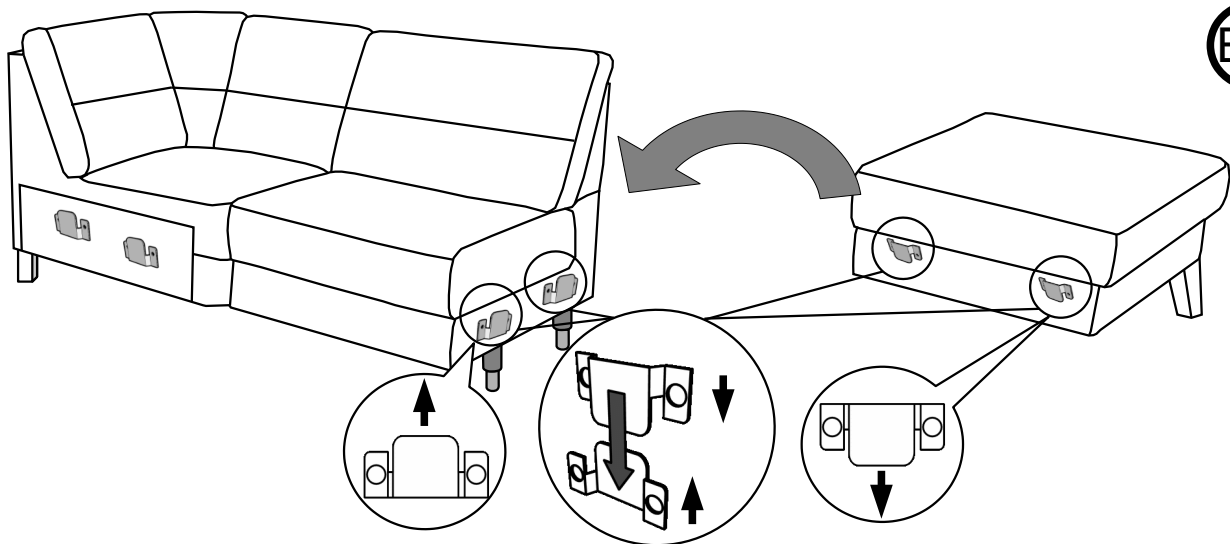



3

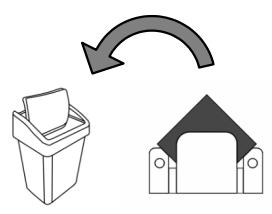
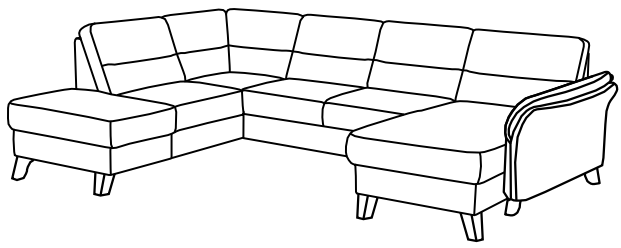

B

C-1

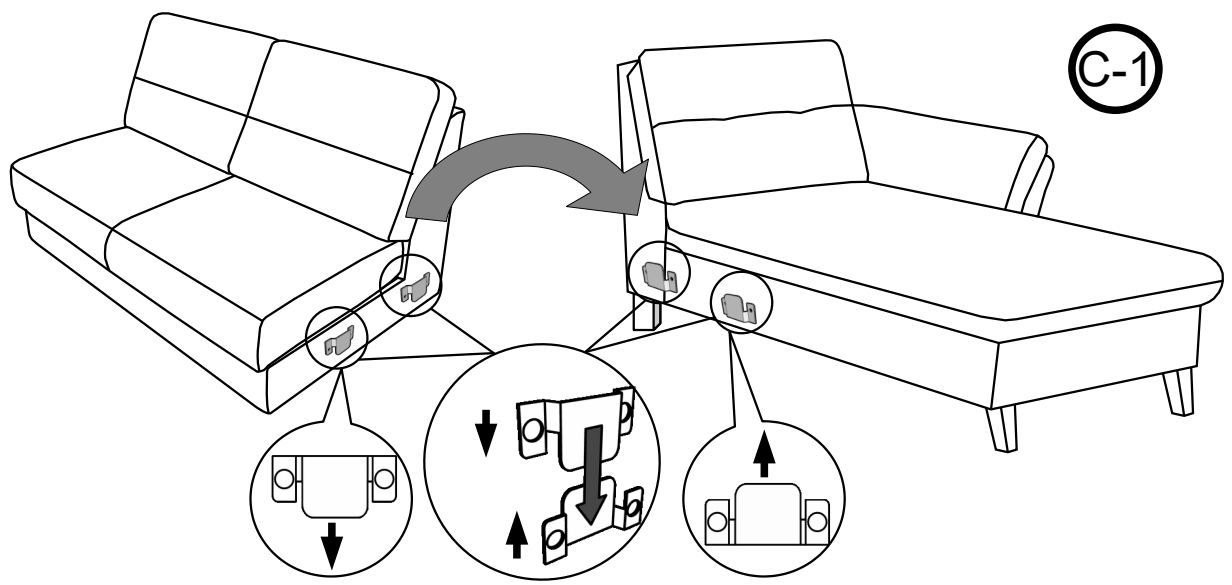

D-2

B

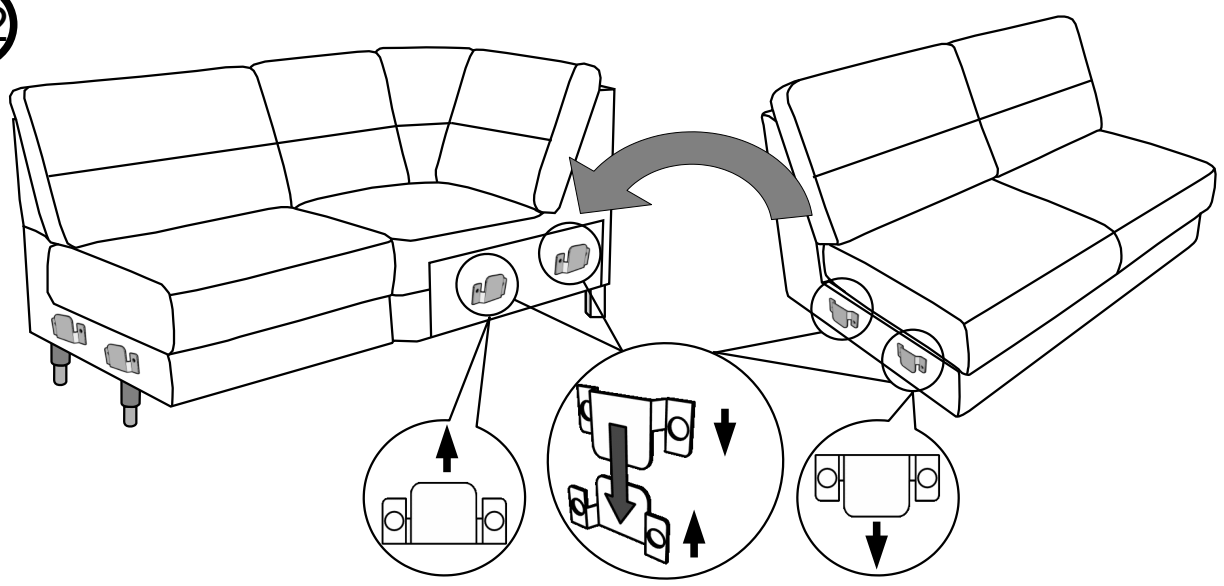

E-2

D-2

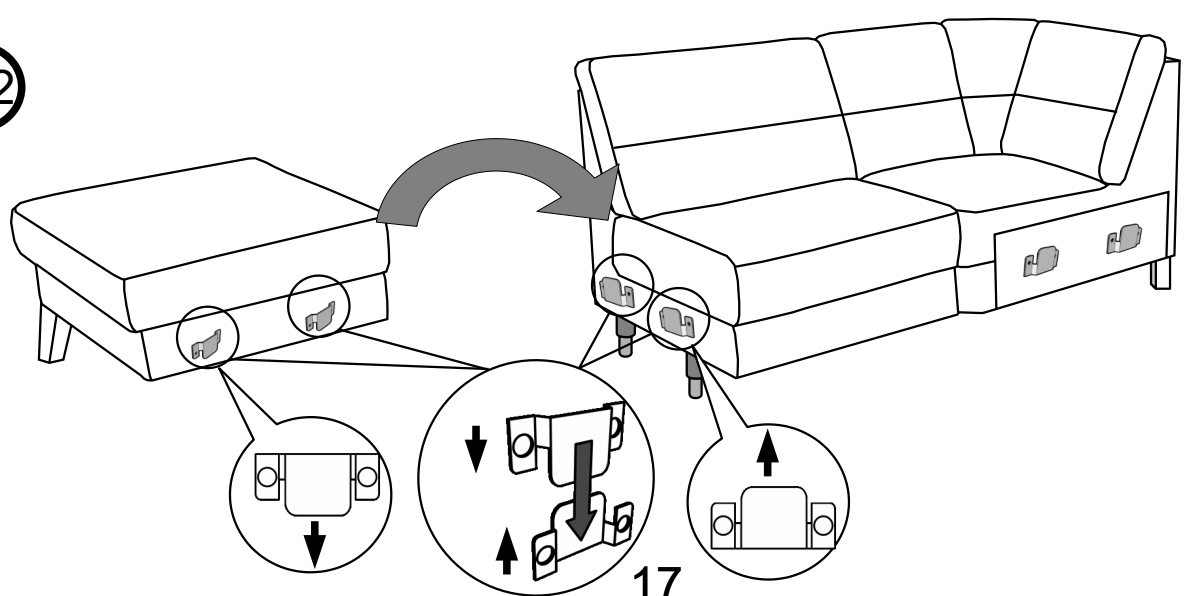

0019

A-1 A-2 B

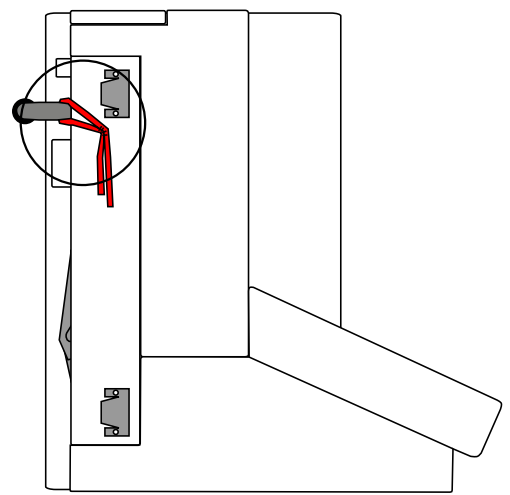
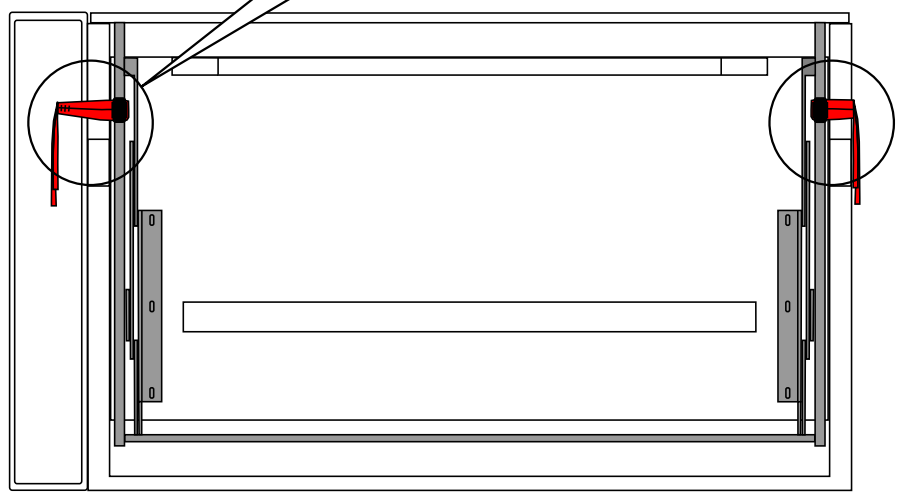
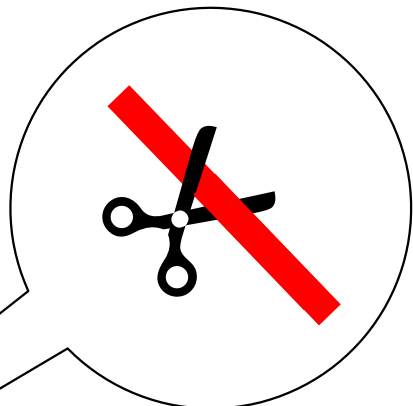
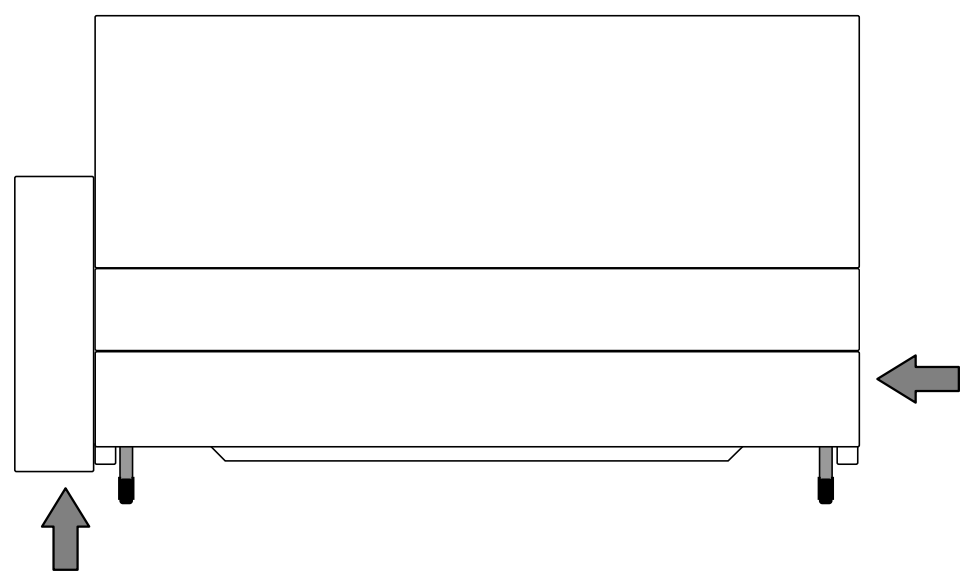
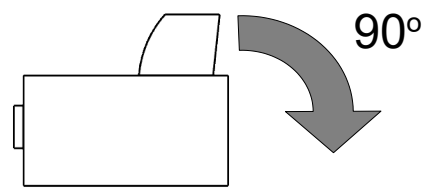

0019 A-1 A-2 B

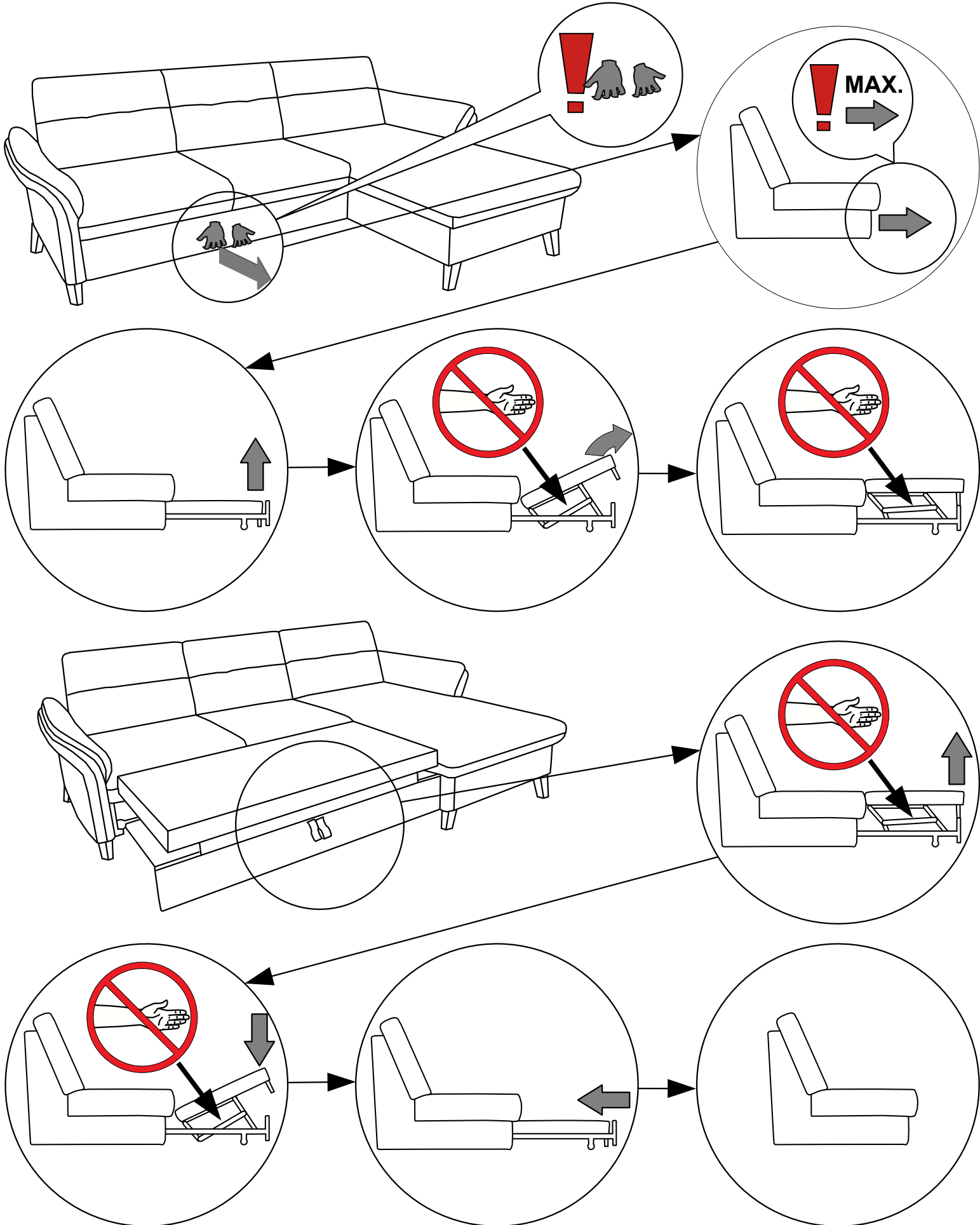
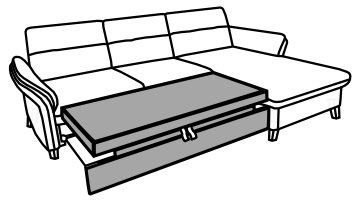
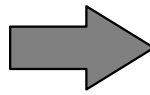
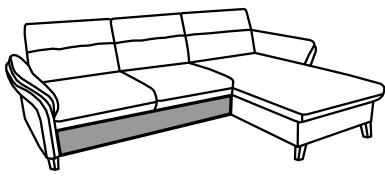

0089

C-1

C-2

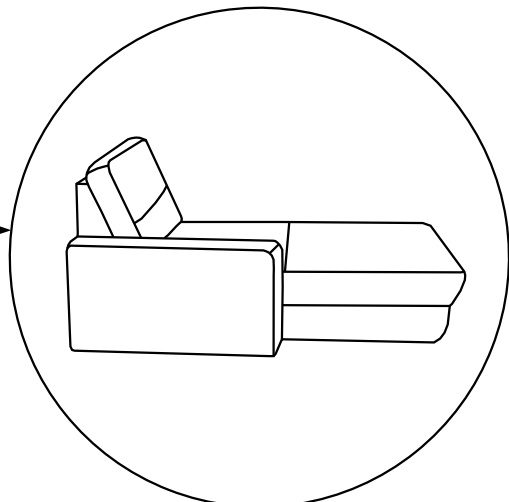
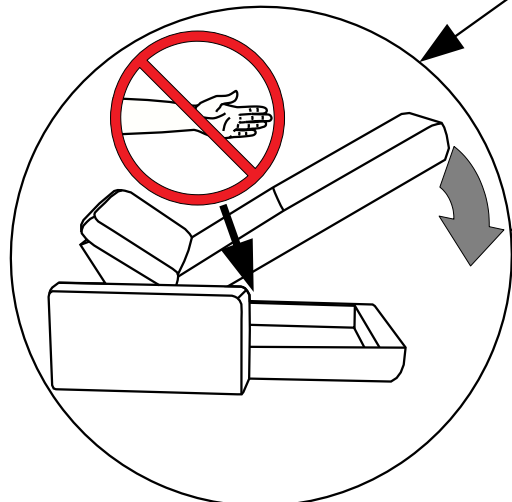
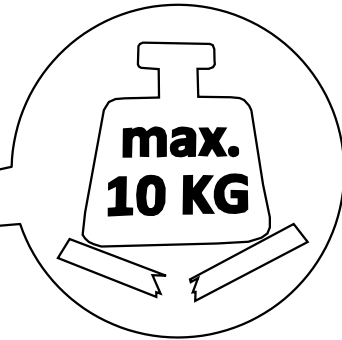
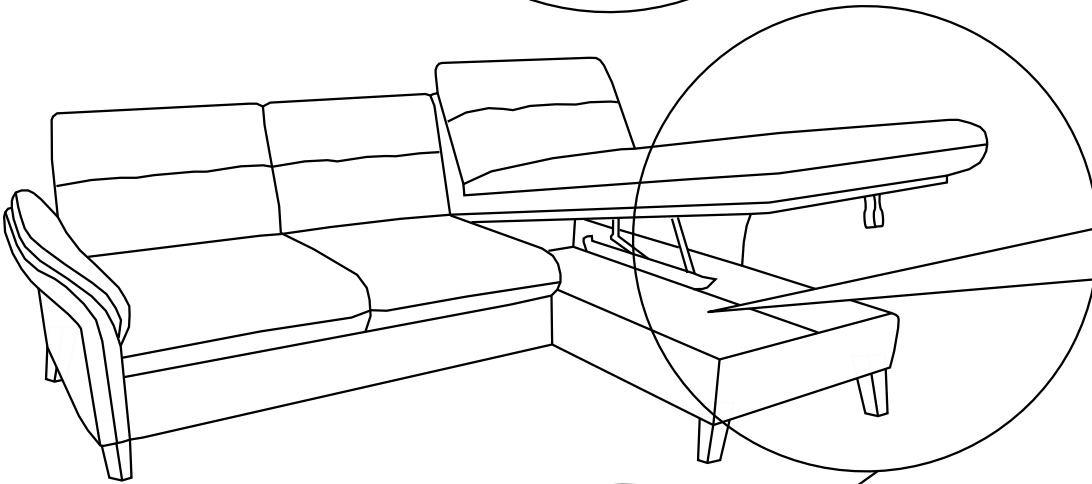
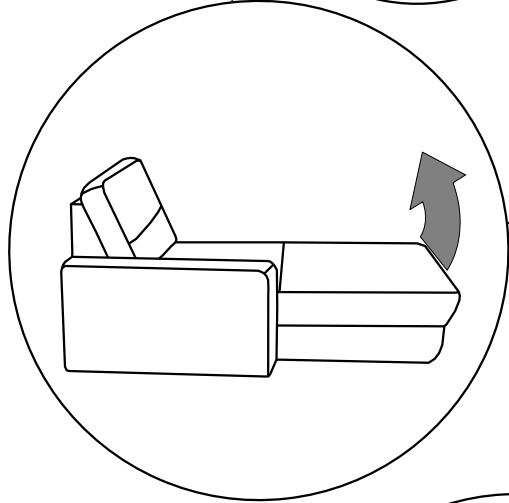
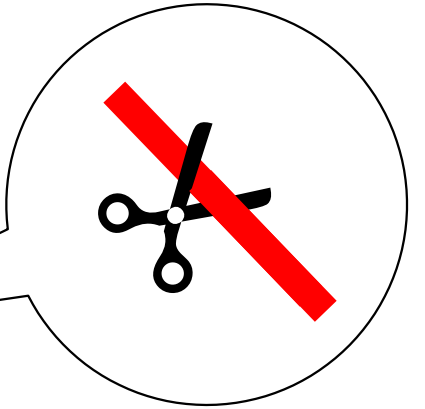
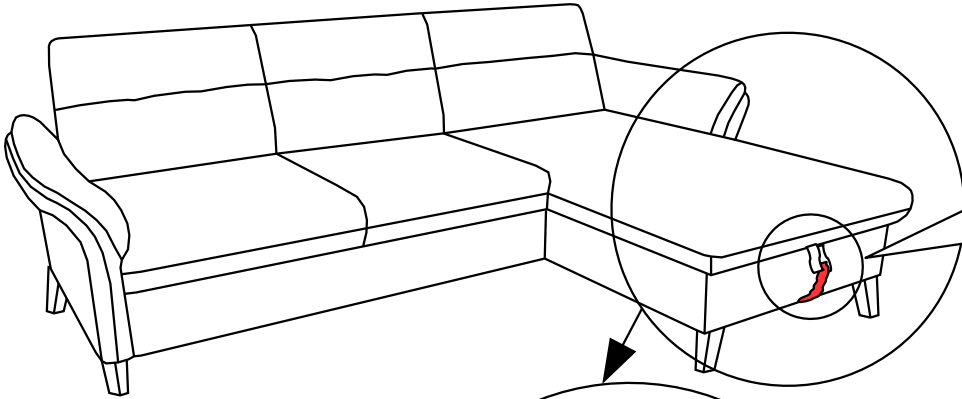
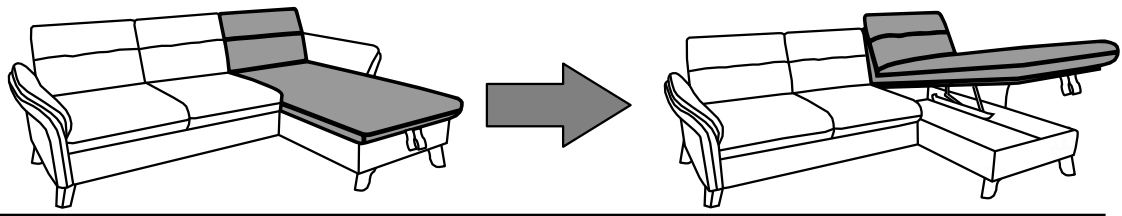

0088

E-1 E-2

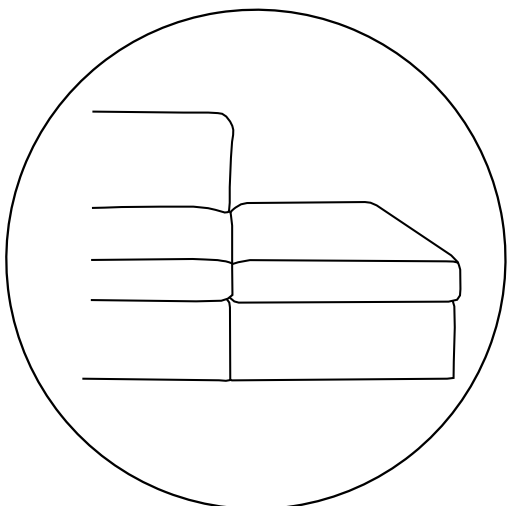
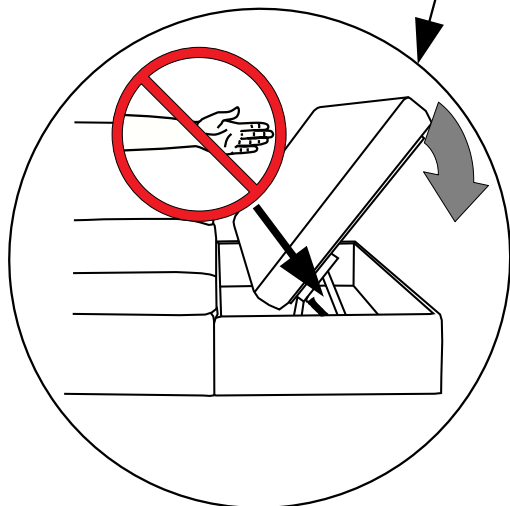
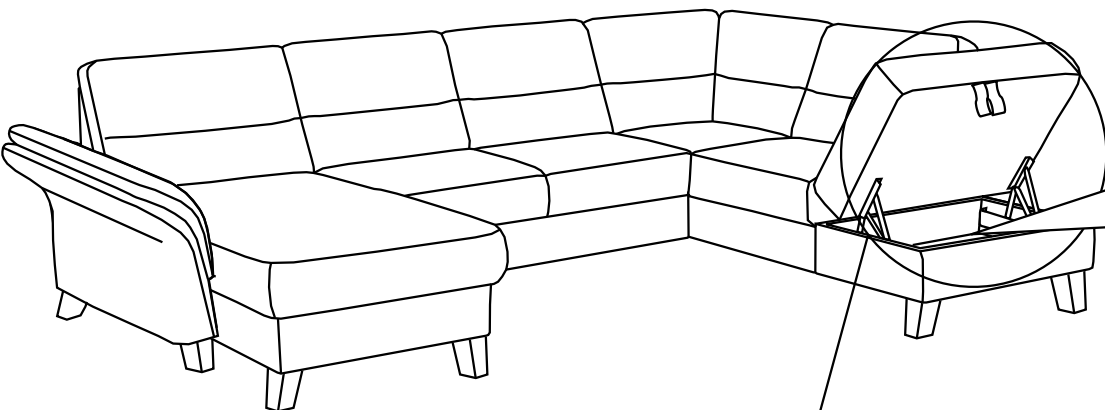
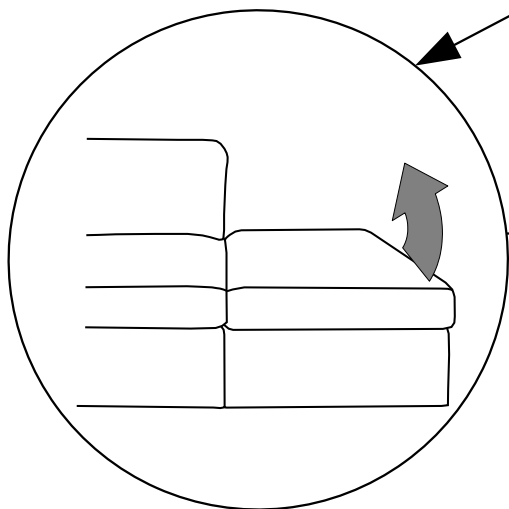
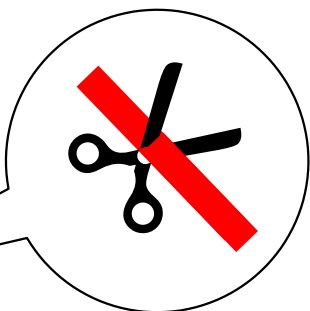
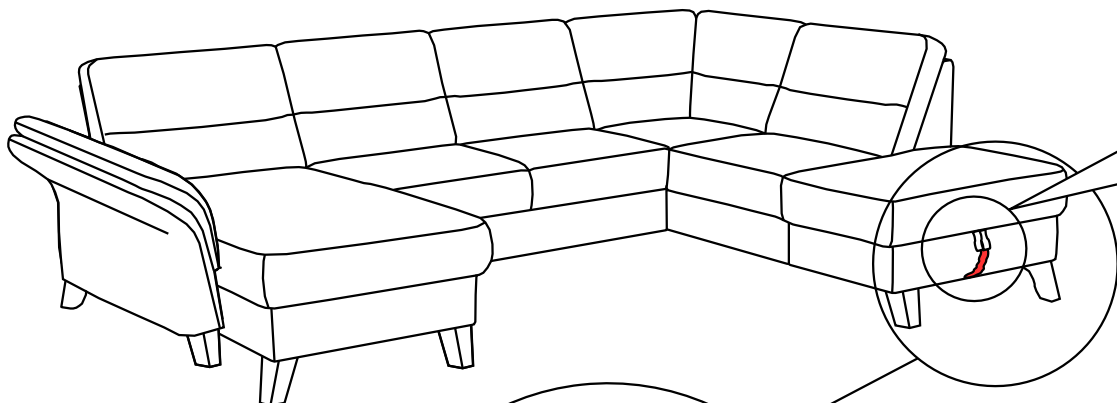
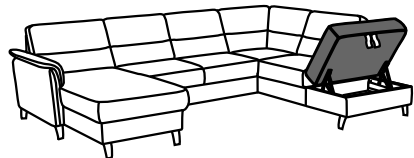
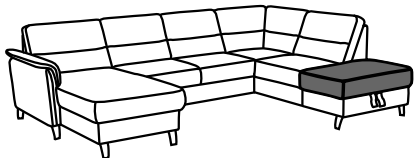

0090

- (A)
- (C)
- (B)
- (D)

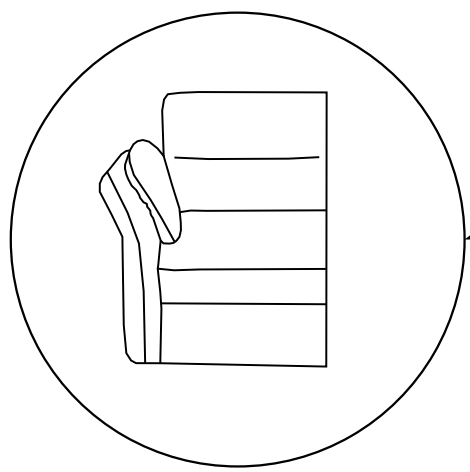
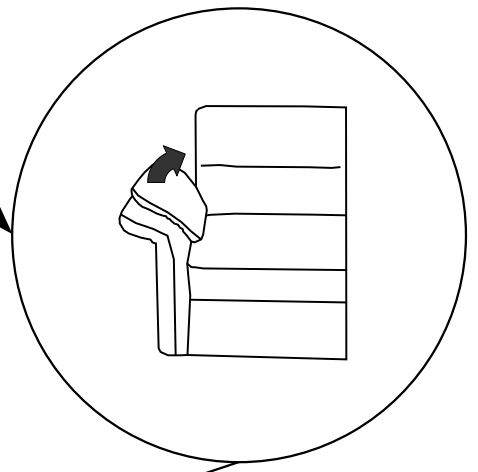
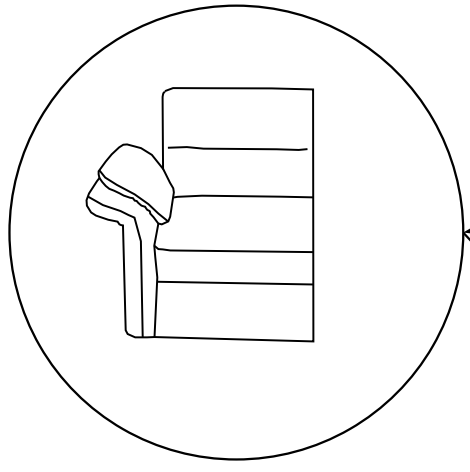
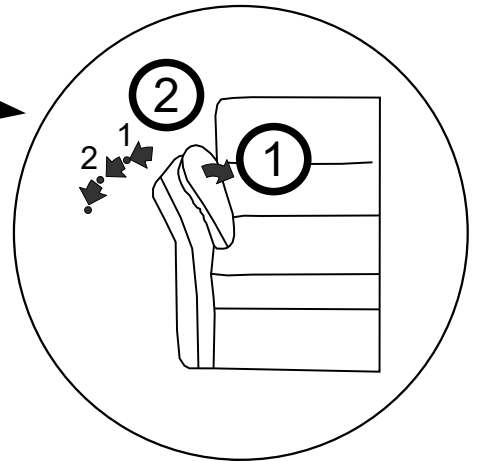
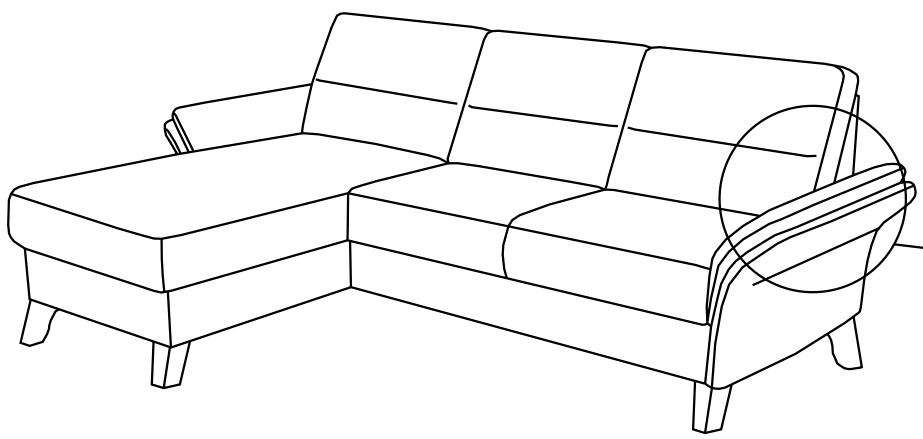
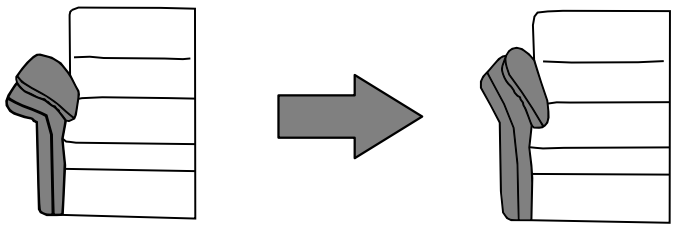

0088

H

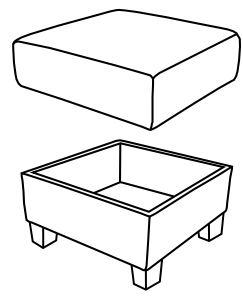
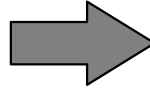
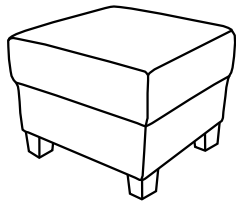

H

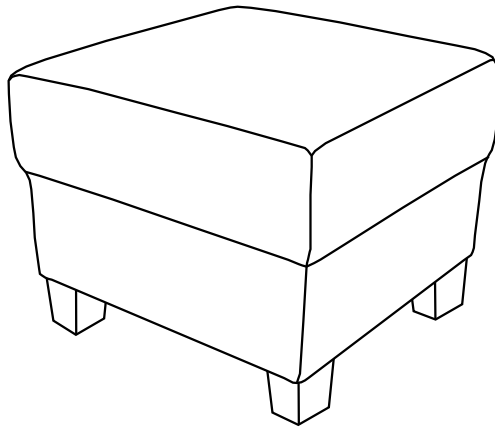

H-1

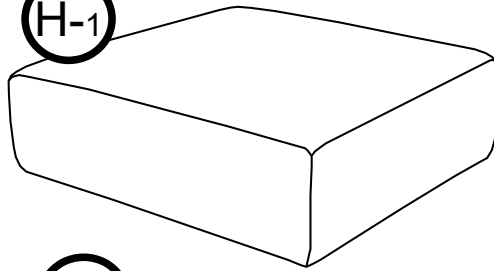

H-2

