

- (D) AUFBAUANLEITUNG
- (NL) HANDLEIDING VOOR DE MONTAGE
- (TR) MONTAJ TALIMATI
- (RO) INSTRUCTIUNI DE ASAMBLARE
- (F) INSTRUCTION D'ASSEMBLAGE
- (CZ) POKYNY K MONTÁŽI
- (BG) ИНСТРУКЦИИ ЗА МОНТАЖ
- (HR) NAPUTCI ZA MONTAŽU
- (E) INSTRUCCIONES DE MONTAJE

- (GB) ASSEMBLY INSTRUCTIONS
- (PL) INSTRUKCJA MONTAŻU
- (RU) Инструкция по монтажу
- (I) PROCEDURA DI ASSEMBLAGGIO
- (SK) POKYNY K MONTÁŽI
- (HU) KÖZGYŰLÉS UTASÍTÁSOK
- (SLD) ASSEMBLY INSTRUCTIONS
- (S) MONTERINGSANVISNING
- (LT) DIEGIMO INSTRUKCIJOS

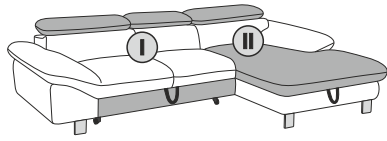

„DRIVER”



2F-REC/BK

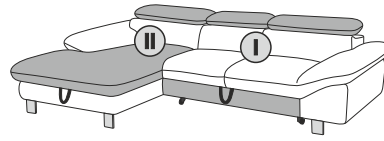

REC/BK-2F

1/2

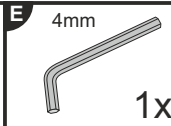
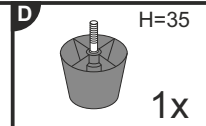
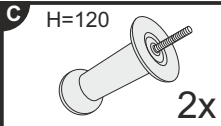
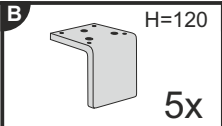
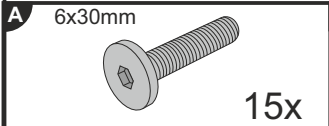

PRE-ASSEMBLED/ PRÉ ASSEMBLÉ/
VORMONTIERT/ PREMONTATO/
WSTĘPNIE ZAMONTOWANE

HARDWARE BAG / SACHET MATÉRIEL / ZUBEHÖRBEUTEL / SACCHETTI MATERIALE / BOLSA DE MATERIALES / WOREK MATERIALOWY

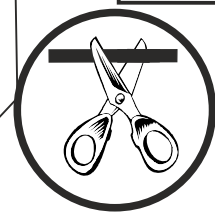
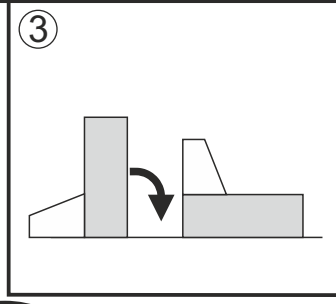
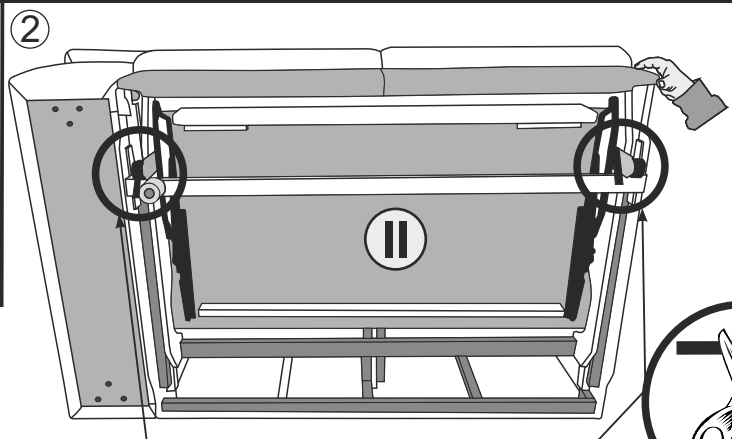
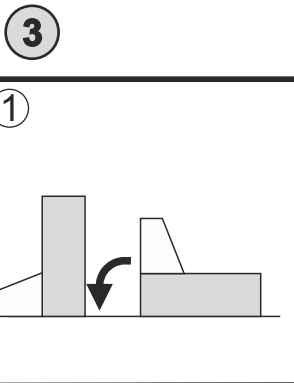
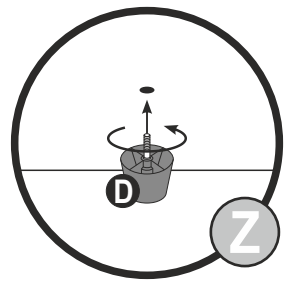
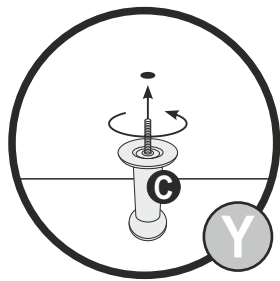
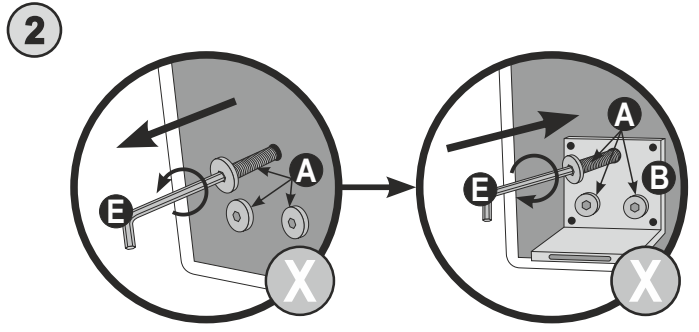
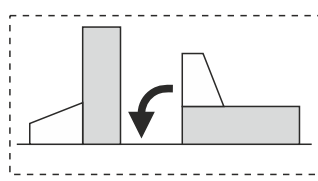
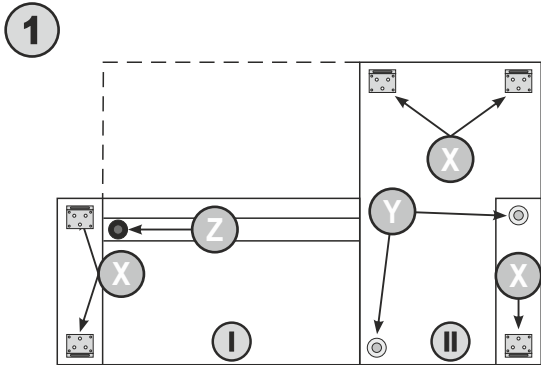
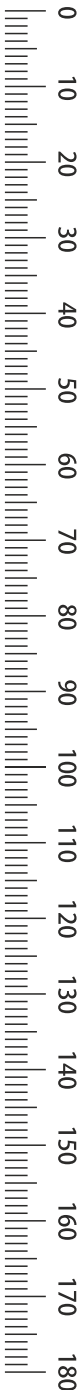

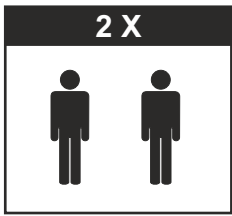

- | | |
|----------------------------------|-------------------------------|
| (D) AUFBAUANLEITUNG | (GB) ASSEMBLY INSTRUCTIONS |
| (NL) HANDLEIDING VOOR DE MONTAGE | (PL) INSTRUKCJA MONTAŻU |
| (TR) MONTAJ TALIMATI | (RU) Инструкция по монтажу |
| (RO) INSTRUCTIUNI DE ASAMBLARE | (I) PROCEDURA DI ASSEMBLAGGIO |
| (F) INSTRUCTION D'ASSEMBLAGE | (SK) POKYNY K MONTÁŽI |
| (CZ) POKYNY K MONTÁŽI | (HU) KÖZGYŰLÉS UTASÍTÁSOK |
| (BG) ИНСТРУКЦИИ ЗА МОНТАЖ | (SLD) ASSEMBLY INSTRUCTIONS |
| (HR) NAPUTCI ZA MONTAŽU | (S) MONTERINGSANVISNING |
| (E) INSTRUCCIONES DE MONTAJE | (LT) DIEGIMO INSTRUKCIJOS |



„DRIVER”

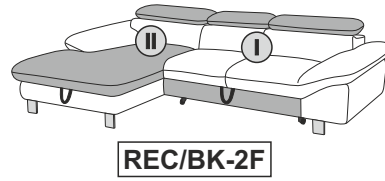
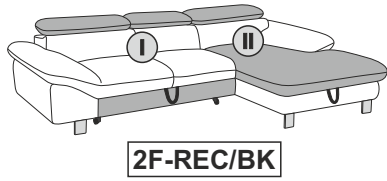

2/2

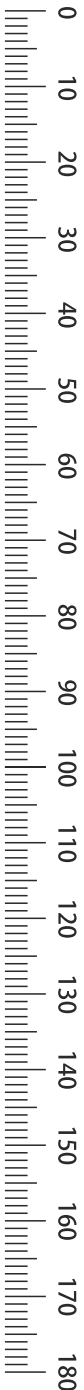
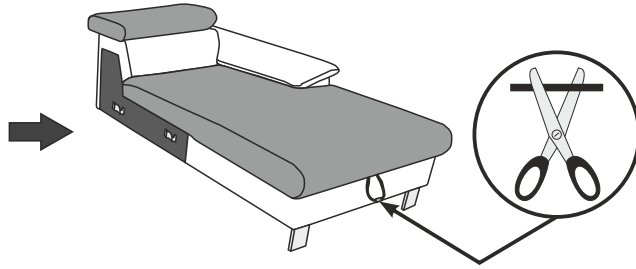
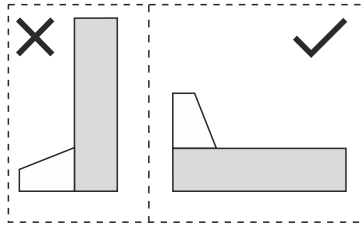

4

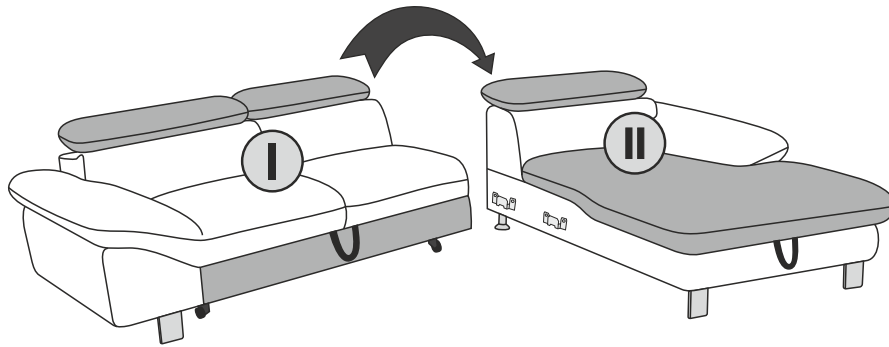

5

